

# QElectroTech

version 0.7

**2020, The QElectroTech Team**

März 21, 2020



# Contents

<b>QElectroTech documentation</b>	<b>1</b>
Basics	1
Launch QElectroTech on Linux	1
Launch QElectroTech from terminal	1
Launch QElectroTech from applications menu	2
Launch QElectroTech on Windows	2
Launch QElectroTech on Mac	3
QElectroTech help menu	4
Tooltips	5
About QElectroTech	5
Online Manual	5
Youtube Channel	5
Support the project	6
About Qt	6
Quit QElectroTech	6
Quit QElectroTech from menu bar	6
Quit QElectroTech using keyboard shortcut	6
Interface	6
Interface elements	7
Menu bar	7
File menu	7
Edit menu	8
Project menu	9
Display menu	9
Settings menu	10
Windows menu	10
Help menu	10
Toolbars	11
Toolbar Tools	11
Toolbar Display	12
Toolbar Diagram	12
Toolbar Add	13
Toolbar Depth	13
Workspace	13
Panels	14
Projects panel	14
Collections panel	14
Selection properties panel	15
Auto Numbering Selection panel	15
Undo panel	17

Projects tabs bar	18
Folio tabs bar	18
Help bar	18
Search menu	19
GUI customization	19
Organize toolbars	19
Organize panels	21
Project visualization	22
Full screen mode	23
Full screen mode from menu bar	23
Full screen mode using keyboard shortcut	23
Preferences	24
Display settings	24
QElectroTech appearance	24
Project visualization	24
Project settings	25
Element settings	25
Collection settings	25
Element management settings	26
Select language	26
Text settings	27
Elements texts	27
Independent texts	27
Summary pages	28
Other texts	28
Grid settings	28
New project settings	29
Folio settings	29
Conductor settings	30
Folio referencings settings	31
Cross references settings	32
Export settings	33
Printing settings	33
Project	34
What is a project?	34
Create new project	35
Create new project from menu bar	35
Create new project from toolbar	35
Create new project using keyboard shortcut	35
Open Project	35
Open project from menu bar	36
Open project from toolbar	36



Open project using keyboard shortcut	36
Files history	36
Save Project	37
Save project from Menu bar	37
Save project from toolbar	37
Save project using keyboard shortcut	37
Close Project	38
Close project from menu bar	38
Close project from toolbar	38
Close project from projects panel	38
Close project from projects tabs bar	39
Close project using keyboard shortcut	39
Clean project	39
Project properties	40
Display project properties	40
Project properties from menu bar	40
Project properties from project panel	40
General properties	41
New folio properties	41
Folio properties	41
Conductor properties	42
Folio referencing properties	43
Cross references properties	44
Auto numbering properties	45
Display auto numbering properties from menu bar	46
Display auto numbering properties from panel	46
Folio	46
What is a folio?	46
Type of folio	47
Single line diagram	47
Multiline diagram	48
Control diagram	48
Add new Folio	49
Add new folio from menu bar	49
Add new folio from projects panel	49
Add new folio from folios tabs bar	49
Add new folio using keyboard shortcut	49
Delete Folio	49
Delete folio from menu bar	50
Delete folio from projects panel	50
Folio properties	50
Display folio properties	50

Display folio properties from menu bar	50
Display folio properties from workspace	51
Display folio properties from toolbar	51
Display folio properties from projects panel	51
Display folio properties from folios tabs bar	52
Display folio properties using keyboard shortcut	52
Folio size	52
Title block properties section	53
Title block selection area	53
Main folio properties tab	53
Costum properties folio tab	54
Folio conductor type	54
Folio conductor appearance	55
Title Block	55
What is the title block?	56
Title block properties	56
Title block parent collection	56
Title block extra information	56
Title Block collections	57
What is a collection?	57
Title block QET collection	57
Title block User collection	58
Title block project collection	58
Title block elements	59
Cell	59
Definition	59
Empty cell	59
Text cell	59
Logo cell	59
Row	60
Definition	60
Properties	60
Column	60
Definition	60
Properties	60
Create new title block	61
Create title block from menu bar	61
Create title block from folio properties	62
Create title block from project panel	62
Edit title block	62
Edit title block from menu bar	63
Edit title block from folio properties	63

Edit title block from project panel	64
Delete title block	64
Delete title block from project	64
Delete title block from collection	65
Title block editor	65
Interface title block editor	65
Elements title block window	65
Title block editor menu bar	66
File menu	66
Edit menu	66
Display menu	67
Settings menu	67
Help menu	67
Toolbars	68
Toolbar Tools	68
Toolbar Edit	68
Toolbar Display	69
Drawing area	69
Title block editor panels	69
Cell properties panel	70
Undo panel	70
Open title block editor	70
Save title block	70
Save title block from menu bar	70
Save title block from toolbar	71
Save title block using keyboard shortcut	71
Quit title block editor	72
Exit QElectroTech title block editor from menu bar	72
Exit QElectroTech title block editor using keyboard shortcut	72
Create or edit title block	72
Add row to title block	72
Add row from menu bar	72
Add row from drawing area	72
Row heigth definition	73
Delete row from title block	73
Add column to title block	73
Add column from menu bar	73
Add column from drawing area	74
Colum width definition	74
Delete column from title block	75
Introduce a logo on the title block	75
Define cell content	76

Add text to cell	76
Add variable to cell	77
Merge cells	78
Merge cells from menu bar	78
Merge cells from toolbar	78
Merge cells using keyboard shortcut	79
Split cells	79
Split cells from menu bar	79
Split cells from toolbar	79
Split cells using keyboard shortcut	79
Define title block extra information	79
Define extra information from menu bar	80
Define extra information using keyboard shortcut	80
Element	80
What is an element?	80
Type of elements	81
Simple element	81
Master element	82
Slave element	83
Reference folio following	84
Previous reference folio	85
Terminal block	86
Element properties	87
Display element properties	87
Display element properties from menu bar	87
Display element properties from workspace	88
Display element properties using keyboard shortcut	88
General properties element	88
Texts from element	89
Element information	89
Element author and license	90
Element numbering	90
Element collection	92
What is a collection?	92
QET collection	92
User collection	92
Project collection	93
Create category	93
Edit category	94
Delete category	95
Folder properties	95
Create element	96

Create element from zero	96
Create an element from an existing element	98
Edit element	98
Delete element	99
Element parts	99
Line	99
Create line	99
Line properties	99
Rectangle	100
Create rectangle	100
Rectangle properties	101
Rounding rectangle vertices	101
Rounding rectangle vertices from information panel	101
Rounding rectangle vertices from workspace	102
Ellipse	102
Create ellipse	102
Ellipse properties	102
Polygon	103
Create polygon	103
Polygon properties	103
Text field	104
Create text	104
Text properties	104
Arc	105
Create arc	105
Arc properties	105
Arc extreme points definition	106
Arc extreme points definition from information panel	106
Arc extreme points definition from workspace	106
Terminal	106
Create terminal	106
Terminal properties	107
Dynamic text	107
Create dynamic text	107
Dynamic text properties	107
Element cross reference	108
Cross reference at master element	108
Cross reference at slave element	109
Element editor	109
What is the element editor?	109
Interface element editor	109
Element editor window	109

Element editor menu bar	110
File menu	110
Edit menu	111
Display menu	112
Settings menu	112
Help menu	112
Element editor toolbars	113
Toolbar Tools	113
Toolbar Display	113
Toolbar Element	113
Toolbar Parts	114
Toolbar Depth	114
Drawing area	115
Element editor panels	115
Parts panel	115
Selection properties panel	115
Undo panel	116
Help bar	116
Open element editor	116
Open element editor by creating a new element	117
Open element editor by editing an element	117
Save element	117
Save element from menu bar	117
Save element from toolbar	117
Save element using keyboard shortcut	118
Quit element editor	118
Exit QElectroTech element editor from menu bar	118
Exit QElectroTech element editor using keyboard shortcut	118
Create or edit elements	119
Graphic definition	119
Working with parts	119
Add part to element	119
Select parts from workspace	119
Select one part	119
Select multiple parts	119
Select multiple objects using keyboard and mouse	119
Select multiple objects by selecting area	120
Select all Parts	120
Select all parts from menu bar	120
Select all parts from workspace	120
Select all objects using keyboard shortcut	121
Select none	121

Select none from menu bar	121
Select none using keyboard shortcut	121
Invert the selection	121
Invert selection from menu bar	121
Invert selection using keyboard shortcut	122
Cut part	122
Cut part from menu bar	122
Cut part by right click	122
Cut part using keyboard shortcut	123
Copy part	123
Copy part from menu bar	123
Copy part by right click	123
Copy part using keyboard shortcut	124
Paste part	124
Paste part from menu bar	124
Paste part by right click	124
Paste part using keyboard shortcut	125
Paste in area	125
Paste part from menu bar	125
Paste part by right click	125
Paste part using keyboard shortcut	126
Paste from	126
Delete part	126
Delete part from menu bar	126
Delete part from toolbar	126
Delete part by right click	126
Delete part using keyboard shortcut	127
Layers in element editor	127
Change element size	128
Element properties definition	128
Define element name	128
Define element name from menu bar	129
Define element name from toolbar	129
Define element name using keyboard shortcut	129
Define author element information	129
Define author element information from menu bar	130
Define author element information using keyboard shortcut	130
Edit element properties	130
Edit element properties from menu bar	130
Edit element properties from toolbar	131
Conductor	131
What is a conductor?	131

Type of conductor	132
Single line conductor	132
Multiline conductor	133
Conductor properties	133
Display conductor properties	133
Display conductor properties from menu bar	133
Display conductor properties from workspace	134
Display conductor properties using keyboard shortcut	134
Conductor type	134
Multiline conductor	134
Single line conductor	135
Conductor appearance	135
Conductor numbering	136
Schema	138
What is a schema?	138
Working with elements	138
Add element	138
Edit element	139
Working with cross reference	139
Bind slave item	139
Bind master item	140
Untie slave item	141
Untie master item	142
Show linked item	142
Show slave linked item	143
Show Master linked item	144
Working with conductors	144
Create conductor	144
Manual conductor creation	144
Automatic conductor creation	145
Modify conductor	147
Reset conductors	147
Reset conductor from menu bar	148
Reset conductor from toolbar	148
Reset conductor from workspace	148
Reset conductor using keyboard shortcut	149
Define text at conductor	149
Change appearance conductor	150
Working with text field	150
Insert text field	150
Edit text field	151
Edit text field from menu bar	151



Edit text field by right click	151
Edit text field using keyboard shortcut	151
Text editor	152
Rich text tab	152
Source tab	152
Move text	152
Move text field by mouse	152
Move text field by keyboard	152
Rotate text	153
Rotate the text field	153
Define text orientation	153
Insert URL link	153
Insert URL link from QElectroTech text editor	154
Insert URL link using external html code generators	154
Insert table	155
Basic objects	156
Line	157
Create line	157
Line properties	157
Line properties from menu bar	157
Line properties by right click	158
Line properties from selection properties panel	158
Line properties using keyboard shortcut	158
Rectangle	159
Create rectangle	159
Rectangle properties	159
Rectangle properties from menu bar	159
Rectangle properties by right click	160
Rectangle properties from selection properties panel	160
Rectangle properties using keyboard shortcut	160
Ellipse	161
Create ellipse	161
Ellipse properties	161
Ellipse properties from menu bar	162
Ellipse properties by right click	162
Ellipse properties from selection properties panel	162
Ellipse properties using keyboard shortcut	162
Polygon	163
Create polygon	163
Polygon properties	163
Polygon properties from menu bar	164
Polygon properties by right click	164

Polygon properties from selection properties panel	164
Polygon properties using keyboard shortcut	164
Add new point to polygon	165
Delete point to polygon	165
Working with pictures	165
Add picture	165
Resize picture	166
Move picture	166
Select objects from workspace	166
Select one object	166
Select multiple objects	167
Select multiple objects using keyboard and mouse	167
Select multiple objects by selecting area	167
Select all objects	167
Select all objects from menu bar	168
Select all objects from workspace	168
Select all objects using keyboard shortcut	168
Select none	168
Invert the selection	169
Invert selection from menu bar	169
Invert selection using keyboard shortcut	169
Copy object	170
Copy object from menu bar	170
Copy object from toolbar	170
Copy object by right click	170
Copy object using keyboard shortcut	171
Cut object	171
Cut object from menu bar	171
Cut object from toolbar	172
Cut object by right click	172
Cut object using keyboard shortcut	172
Paste object	172
Paste object from menu bar	173
Paste object from toolbar	173
Paste object by right click	173
Paste object using keyboard shortcut	173
Multiple paste	173
Delete object	174
Delete object from menu bar	175
Delete object from toolbar	175
Delete object by right click	175
Delete object using keyboard shortcut	175

Rotate object	176
Rotate object from menu bar	176
Rotate object from toolbar	177
Rotate object by right click	177
Rotate object using keyboard shortcut	177
Object layer level	177
Define object layer from menu bar	178
Define object layer from toolbar	178
Define object layer by right click	178
Define object layer using keyboard shortcut	178
Search	179
Replace	179
Replace text field content	179
Replace folio property	180
Replace element property	181
Replace conductor property	182
Advanced replace	183
Drawing	185
Design mounting plate	185
Design Local Control Panel (LOP)	186
Reports	187
Project index	187
Component list	188
Conductor list	188
I/O list	189
Export and print	189
Print project	189
Print project from menu bar	189
Print project from toolbar	190
Print project using keyboard shortcut	190
Create a PDF from a project	190
Export project to PDF from menu bar	190
Export project to PDF from toolbar	191
Export project to PDF using keyboard shortcut	191
Export schema	192
Export component list	194
Annex	194
Default QElectroTech variables	194
General project variables	194
variables related to folio	194
variables related to element	195
variables related to conductor	195

QElectroTech text font	195
Color selection	196
Basic color	196
Custom color	196

# QElectroTech documentation

## Basics

### Launch QElectroTech on Linux

After installation, Linux allows the user launching applications from many different ways. Below, the most common ways are explained.

### Launch QElectroTech from terminal

To launch QElectroTech using the terminal, the command to be used is:

```
$ qelectrotech
```

The command mentioned above blocks the terminal for other processes. If the terminal should be available for other processes, the command to launch QElectroTech is:

```
$ qelectrotech &
```

### Note

If the command is not working, list the applications installed and check the name with which QElectroTech has been installed.

- Ubuntu command: `$ apt list --installed`

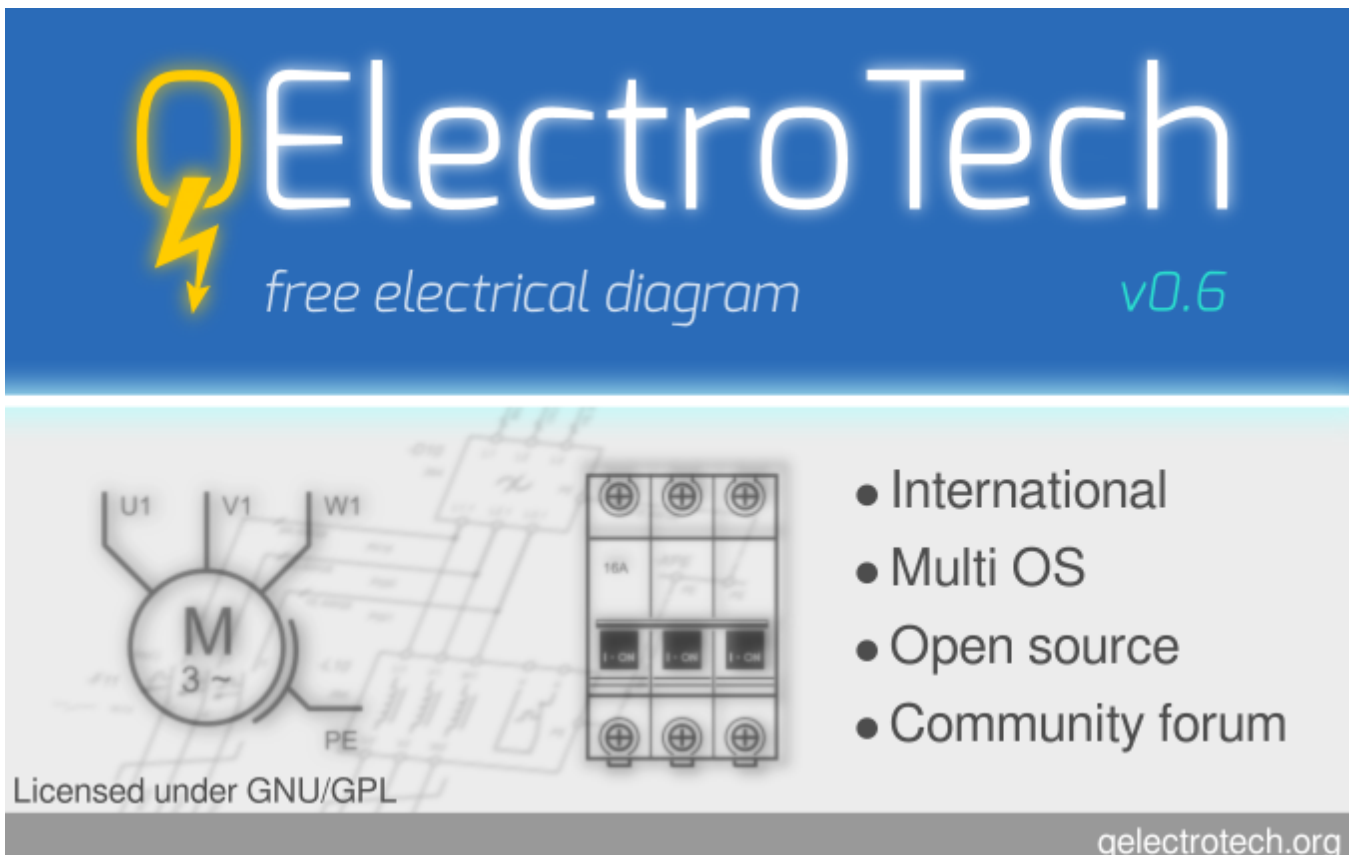

Figure: Splash screen

## Launch QElectroTech from applications menu

As Windows, Linux operative systems allow the user to launch applications from menus and icons. Where to go depends on the theme and distribution used. Below, some possibilities according some configurations are mentioned.

- Unity theme: The icon appears at the launcher bar.
- Gnome shell: The icon appears at **[Menu]**, with the rest of applications.
- Gnome Classic: QElectroTech can be started from **Applications > Graphics > QElectroTech**.
- KDE: QElectroTech can be started from **[Menu]** at **Graphics > QElectroTech**.

Once QElectroTech has been launched, the main window looks as follow:

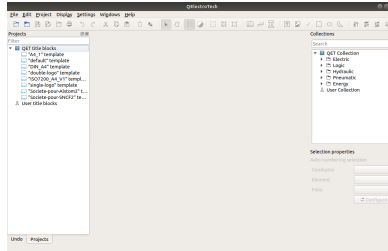

Figure: Main window QElectroTech

## Launch QElectroTech on Windows

After installation, QElectroTech can be launched from Windows Start Menu. If the shortcut icon has been created at the desktop during installation, QElectroTech can also be launched from that icon.

1. Click the Windows **[Start]** button.
2. Select **All Programs**.
3. Open **QElectroTech** program group.
4. Click QElectroTech icon.

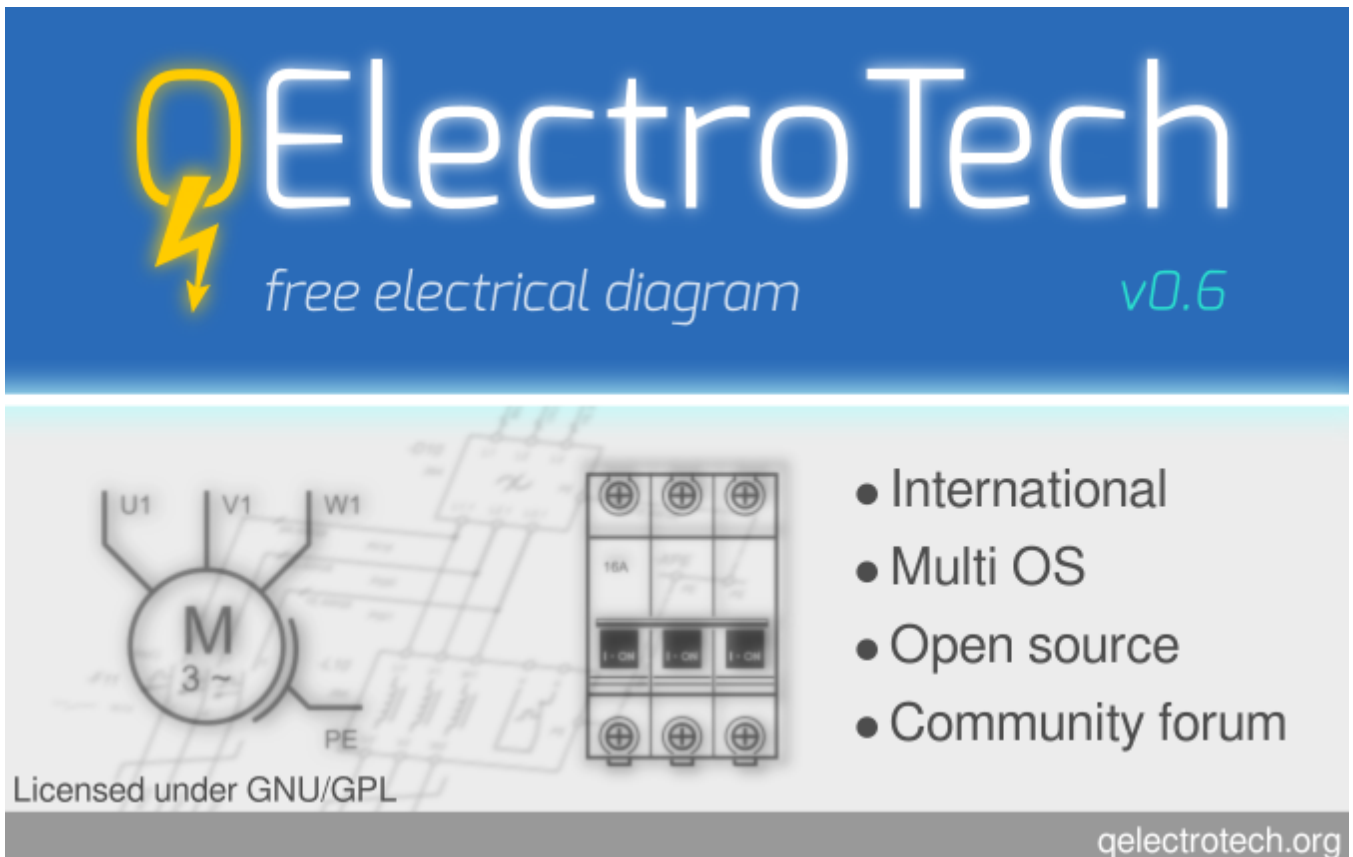

Figure: Splash screen

Once QElectroTech has been launched, the main window looks as follow:

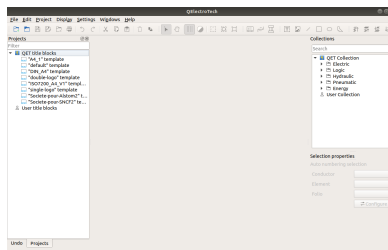

Figure: Main window QElectroTech

## Launch QElectroTech on Mac

After installation, QElectroTech can be launched from applications folder.

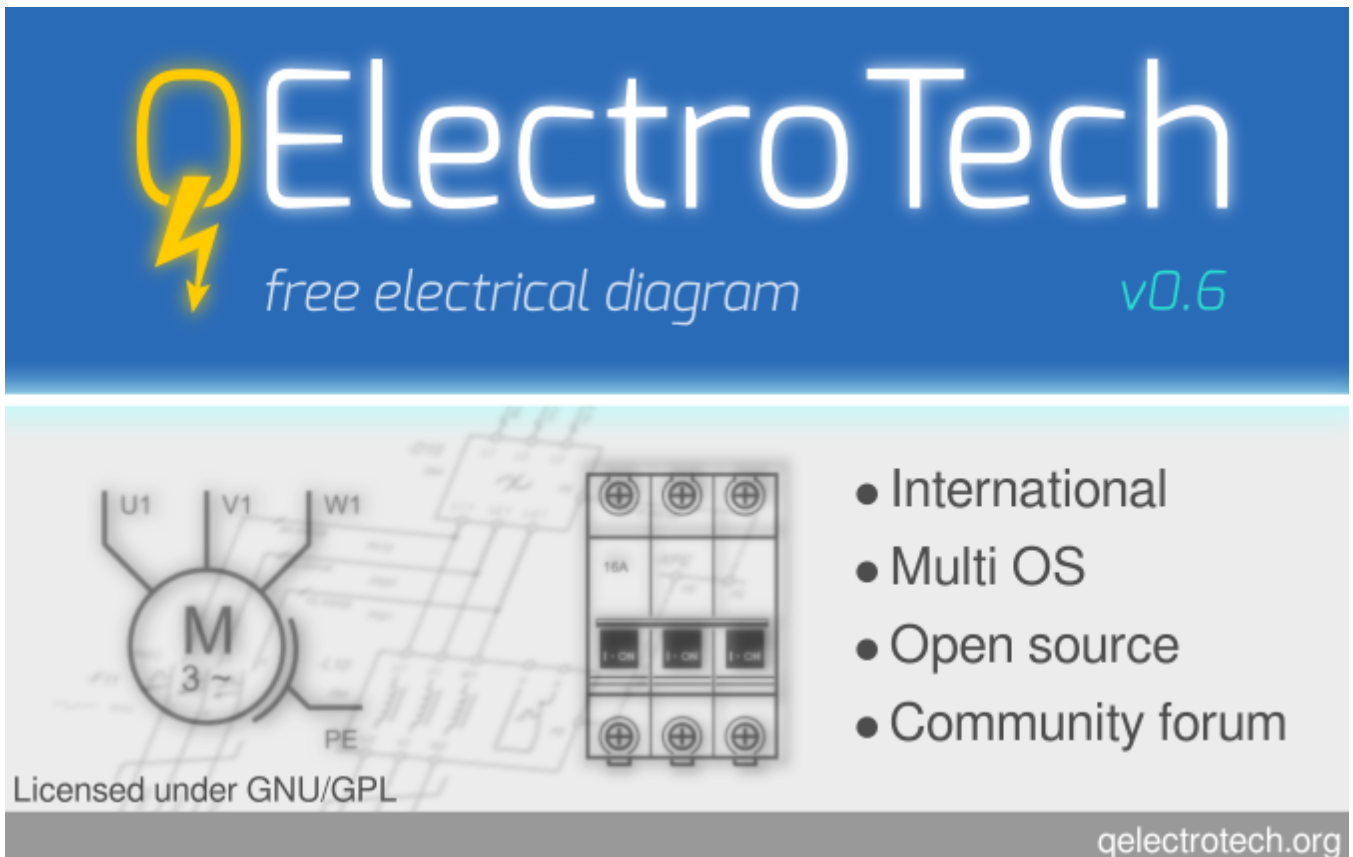

Figure: Starting splash screen

### Note

For easier access, QElectroTech can be added to the dock. Just open the applications folder and drag QElectroTech to the dock.

Once QElectroTech has been launched, the main window looks as follow:

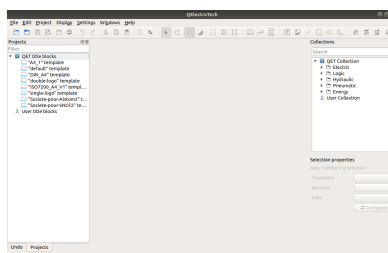

Figure: Main window QElectroTech

### QElectroTech help menu

QElectroTech has been designed with some tools which help the user and makes easier the searching of information. All those tools can be found at **Help** menu from [menu bar](#).

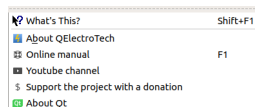

Figure: Help menu QElectroTech



## Tooltips

To support the user, tooltips are displayed when the mouse arrow is placed on an icon from the [toolbars](#). A tooltip is a short message which defines the action corresponding to the icon.

QElectroTech also allows the display from tooltips, or short description panels, at many different areas and objects from the main window. These panels are not displayed automatically with the placement of the mouse arrow on the object or area.

1. Select **Help > What's this?** menu item.
2. Press on the object or area to display the description panel.

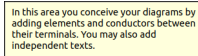

*Figure: Message which appears at the workspace*

To increase the working efficiency, the description panel can also be displayed using keyboard shortcut. The user does not need to resort to the **Help** menu.

1. Press `shift + f1`.
2. Press on the object or area to display the description panel.

## Note

The tool **What's this?** does not give the description from everything, it gives only the description for the different type of collections ([title blocks](#) and [elements](#)), the [workspace](#), [project](#) area and a few objects and areas more.

## About QElectroTech

Many information related to QElectroTech can be found at the application without searching on Internet. Everybody who launch the application can find the license text, version of the application launched, developers and collaborators.

1. Select **Help > About QElectroTech** menu item to display the PopUP window with the basic information from QElectroTech project.

## Online Manual

**Help** menu can address the user to the official online documentation.

1. Select **Help > Online Manual** menu item to open the official QElectroTech online documentation at default browser.

When the application is active on the computer, the user can also open the online manual at default browser using keyboard shortcut.

1. Press `f1` to open the official online manual on the browser.

## Seealso

For more information about QElectroTech keyboard shortcut, refer to [menu bar](#) section.

## Youtube Channel

Many different video tutorials about QElectroTech can be found on Internet. **Help** menu can address the user to the official [Youtube](#) channel of the project.

1. Select **Help > Youtube Channel** menu item to open the QElectroTech [Youtube](#) channel at default browser.

### Support the project

If the user is satisfied with the work already made by the developer team from QElectroTech and he wants to help the project with an economical donation, **Help** menu can address the user to the official [PayPal](#) account of the project.

1. Select **Help > Support the project with a donation** menu item to open the official [PayPal](#) account from QElectroTech at default browser.

### About Qt

QElectroTech has been designed using [Qt](#) framework and widget toolkit. **Help** menu allows going to the official web from [Qt](#) project without the need of searching on Internet.

1. Select **Help > About Qt** menu item to open the official web from [Qt](#) at default browser.

### Quit QElectroTech

The user can quit QElectroTech at anytime. The user does not need to [close the project](#) before closing the application.

If the current work wants to be saved before closing the project, refer to [save project](#) section. Even so, QElectroTech displays an automatic message to save the current job if any modification has been created.



Figure: QElectroTech Save message

As a large amount of applications which has been developed using [Qt](#), QElectroTech can be closed from the close tab  which can be found at top right from main window, from [menu bar](#) or using the corresponding keyboard shortcut.

### Quit QElectroTech from menu bar

1. Select **File > Quit** menu item to quit QElectroTech.

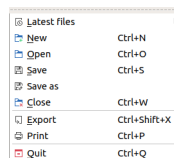

Figure: QElectroTech File menu

### Quit QElectroTech using keyboard shortcut

QElectroTech allows using keyboard shortcut to increase the working efficiency.

1. Press `Ctrl + q` to quit QElectroTech.

Seealso

For more information about QElectroTech keyboard shortcuts, refer to [menu bar](#) section.

## Interface elements

QElectroTech has been designed using Qt framework and widget toolkit. The main window from QElectroTech is the same for all platforms where it is available (Windows, Linux/Unix and MacOS). The main window from QElectroTech contains the following areas:

1. Menu bar
2. Toolbars
3. Workspace
4. Panels
5. Project tabs bar
6. Folio tabs bar
7. Help bar
8. Search Menu

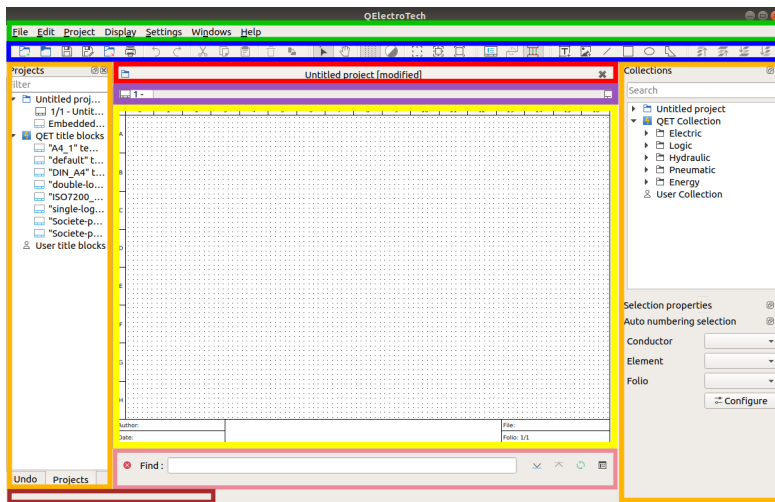

Figure: QElectroTech main window

## Menu bar

The menu bar is placed at top from QElectroTech interface. QElectroTech contains the menus File, Edit, Project, Display, Settings, Windows and Help. Each menu provides many different options.

### Note

A brief description of each menu option can be read from [help](#) or [information](#) tool bar by hovering over the option with the cursor.

## File menu

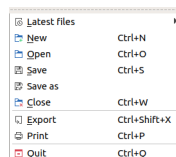











Figure: QElectroTech file menu

Option	Function	Keyboard shortcut	Icon
--------	----------	-------------------	------

Latest files	Opens a project from history (recently opened files)		
New	Creates a new Project	Ctrl + n	
Open	Opens an existing project	Ctrl + o	
Save	Saves the current project and all its folios	Ctrl + s	
Save as	Saves the current project with a different file name		
Close	Closes the current project	Ctrl + w	
Export	Exports the curret folio to another format	Ctrl + Shift + x	
Print	Print one or more folio of the current project	Ctrl + p	
Quit	Closes QElectroTech	Ctrl + q/ Alt + F4	

### Edit menu

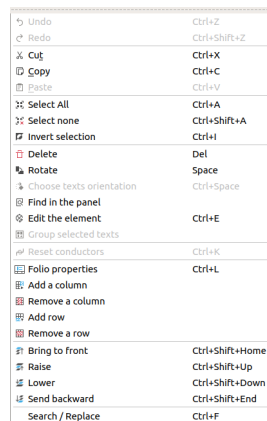

























Figure: QElectroTech edit menu

Option	Function	Keyboard shortcut	Icon
Undo	Undoes the previous action	Ctrl + z	
Redo	Restores the undone action	Ctrl + y	
Cut	Puts selected elements into the clipboard	Ctrl + x	
Copy	Copies selected elements	Ctrl + c	
Paste	Pastes elements from the clipboard into the folio	Ctrl + v	
Select All	Selects all elements on the folio	Ctrl + a	
Select none	Deselect all elements on the folio	Ctrl + Shift + a	
Invert selection	Inverts selection of elements	Ctrl + i	
Delete	Removes selected elements from the folio	Del	
Rotate	Rotates selected elements and texts	Space	
Choose texts orientation	Rotates selected texts to a specific angle	Ctrl + Space	
Find in the panel	Finds the selected element in the collections panel		
Edit the selected object	Displays properties for the selected element / conductor	Ctrl + e	

Group selected texts			
Reset conductors	Resets the conductors path ignoring the user changes	Ctrl + k	
Folio properties	Edits the properties of the folio	Ctrl + l	
Add a column	Adds a column to the folio		
Remove a column	Removes a column from the folio		
Add a row	Adds a row to the folio		
Remove a row	Removes a row from the folio		
Bring to front	Brings the selection (s) to front	Ctrl + Shift + Home	
Raise	Approachs the selection (s)	Ctrl + Shift + Up	
Lower	Moves away the selection (s)	Ctrl + Shift + Down	
Send backwards	Sends in the backwards the selection (s)	Ctrl + Shift + End	
Search / Replace	Display Search / Replace panel	Ctrl + f	

### Project menu

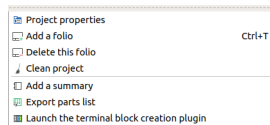









Figure: QElectroTech project menu

Option	Function	Keyboard shortcut	Icon
Project properties	Display project properties PopUp window		
Add a folio	Adds a new folio (drawing sheet) to the active project.	Ctrl + t	
Delete this folio	Deletes the active folio (drawing sheet) of the project		
Clean project	Purges the active project of unused elements and empty categories and templates		
Add a summary	Creates an index folio for the active project		
Export parts list	Generates a .csv file summary of all elements used in the active project		
Launch the terminal block creation plugging			

### Display menu

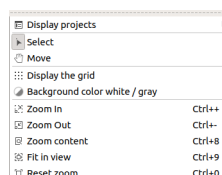

Figure: QElectroTech display menu

Option	Function	Keyboard shortcut	Icon
Display projects	Shows the various opened projects in windows or tabs		
Select	Allows to select elements		
Move	Allows to view the folio without modifying it		
Display the grid	Displays or hidden the grid of folio		
Background color white / gray	Displays the background color of the folio in white or gray		
Zoom In	Expands the folio	Ctrl + +	
Zoom Out	Shrinks the folio	Ctrl + -	
Zoom content	Adjusts the zoom to display all the content of folio regardless of context	Ctrl + 8	
Fit in view	Adjusts the zoom on exactly the part of the folio	Ctrl + 9	
Reset zoom	Restores default zoom level	Ctrl + 0	

### Settings menu

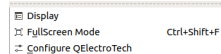

Figure: QElectroTech settings menu

Option	Function	Keyboard shortcut	Icon
Display	Displays or hides toolbars and panels		
Full screen mode	Displays QElectroTech in full screen mode	Ctrl + Shift + f	
Configure QElectroTech	Allows specifying various parameters for QElectroTech		

### Windows menu

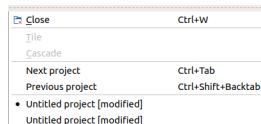

Figure: QElectroTech windows menu

Option	Function	Keyboard shortcut	Icon
Close	Closes the current project	Ctrl + f4	
Tile	Adds a new drawing sheet to the active project. (Folio means drawing sheet)		
Cascade	Deletes the active drawing of the project		
Next Project	Activates the next project	Ctrl + tab	
Previous Project	Activates the previous project	Ctrl + Shift + Backtab	
(Opened Projects)	Below <b>Previous Project</b> QElectroTech list all opened projects to select the active project		

### Help menu

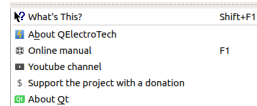

Figure: QElectroTech help menu

Option	Function	Keyboard shortcut	Icon
What's This?	Enquires main menu options	Shift + f1	
About QElectroTech	Displays information about QElectroTech		
Online manual	Lauches the default browser to the online manual of QElectroTech	f1	
Youtube channel	Lauches the default browser on the Youtube channel of QElectroTech		
Support the project with a donation	Lauches the default browser on the QElectroTech donation paypal account		\$
About Qt	Displays information about Qt library		

## Toolbars

In addition to the different [menus](#), QElectroTech also provides toolbars. The toolbars are groups of buttons with icons which initiate accions. In general, these buttons have its counterpart at one of the menus from the [menu bar](#).

### Note

To help the user, a tooltip is displayed when the arrow is placed on each button.

## Toolbar Tools

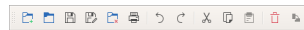

Figure: QElectroTech toolbar Tools

The different buttons from toolbar **Tools** are:

Tool	Function	Keyboard shortcut	Icon
New	Creates a new Project		
Open	Opens an existing project	Ctrl + o	
Save	Saves the current project and all its folios	Ctrl + s	
Save as	Saves the current project with a different file name		
Close	Closes the current project	Ctrl + w	
Print	Print one or more folio of the current project	Ctrl + p	
Undo	Undoes the previous action	Ctrl + z	
Redo	Restores the undone action	Ctrl + Shift + z	
Cut	Puts selected elements into the clipboard	Ctrl + x	
Copy	Copies selected elements	Ctrl + c	
Paste	Pastes elements from the clipboard into the folio	Ctrl + v	
Delete	Removes selected elements from the folio	Del	

Rotate	Rotates selected elements and texts	Space	
--------	-------------------------------------	-------	---







**Note**

Select **Settings > display > Tools** menu item to display or hidden the toolbar **Tools**.

**Toolbar Display**

Figure: QElectroTech toolbar Display

The different buttons from toolbar **Display** are:

Tool	Function	Keyboard shortcut	Icon
Select	Allows to select elements		
Move	Allows to view the folio without modifying it		
Display the grid	Displays or hidden the grid of folio		
Background color white / gray	Displays the background color of the folio in white or gray		
Zoom content	Adjusts the zoom to display all the content of folio regardless of context	Ctrl + 8	
Fit in view	Adjusts the zoom on exactly trhe part of the folio	Ctrl + 9	
Reset zoom	Restores default zoom level	Ctrl + 0	



**Note**

Select **Settings > Display > Display** menu item to display or hidden the toolbar **Display**.

**Toolbar Diagram**

Figure: QElectroTech toolbar Diagram

The different buttons from toolbar **Diagram** are:

Tool	Function	Keyboard shortcut	Icon
Folio properties	Edits the properties of the folio	Ctrl + l	
Reset conductors	Resets the conductors path ignoring the user changes	Ctrl + k	
Automatic creation conductor	Using the automatic creation of conductor (s) when possible		

**Note**

Select **Settings > Display > Diagram** menu item to display or hidden the toolbar **Diagram**.



## Toolbar Add



Figure: QElectroTech toolbar Add

The different buttons from toolbar **Add** are:

Tool	Function	Keyboard shortcut	Icon
Add a textfield	Adds a text field to the current folio		
Add a picture	Adds an image to the current folio		
Add line	Adds a line to the current folio		
Add a rectangle	Adds a rectangle to the current folio		
Add an ellipse	Adds an ellipse to the current folio		
Add a polygon	Adds a polyline to the current folio		

### Note

Select **Settings > Display > Add** menu item to display or hidden the toolbar **Add**.

## Toolbar Depth



Figure: QElectroTech toolbar Depth

The different buttons from toolbar **Depth** are:

Tool	Function	Keyboard shortcut	Icon
Bring forward	Brings the selection (s) to front	Ctrl + shift + Home	
Raise	Approachs the selection (s)	Ctrl + shift + Up	
Lower	Moves away the selection (s)	Ctrl + shift + Down	
Send backwards	Sends in the backwards the selection (s)	Ctrl + shift + End	

### Note

Select **Settings > Display > Depth** menu item to display or hidden the toolbar **Depth**.

## Workspace

The workspace, also named graphical editor, is the area where the diagrams, schematics and reports (index table, component list, symbol glosary, etc.) are created.

The QElectroTech workspace looks as follow:

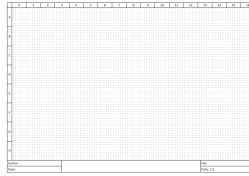

Figure: QElectroTech Workspace

## Panels

### Projects panel

The projects panel displays the opened projects trees, folios and embedded title blocks. The QET and user collection title blocks are also displayed at the projects panel.

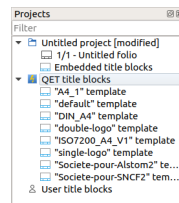

Figure: QElectroTech Projects panel

To display or hidden the projects panel:

1. Select **Settings > Display > Projects** menu item.

The tasks which can be done from projects panel are:

- Manage folios (Add folios, define folio order at each project, etc.).
- Manage the embedded title blocks from the project.
- Manage the default QET title block collection.
- Manage the user title block collection.
- Define the active project.
- Define the active folio which should be displayed at the workspace.
- Display the folio properties PopUP window.
- Display the project properties PopUP window.

To make easier the work with the project panel, QElectroTech provides a filter. All folios, projects and title blocks without a name or part of a string can be hidden.

### Collections panel

The collections panel displays the QET, user and projects element collections.

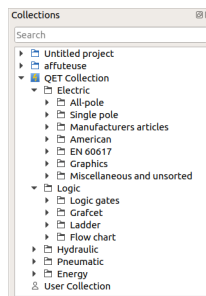

Figure: QElectroTech collections panel

To display or hidden the collections panel:

### 1. Select **Settings > Display > Collections** menu item.

The main function from the collections panel is to manage [elements](#). The tasks which can be done from collections panel are:

- Manage [user](#) collection (Create, edit and delete elements from the collection).
- Edit elements from project collection.
- Search elements from the project collection at the [workspace](#).
- Import elements from [QET](#) or [user](#) collection to the project (Add new element to workspace).

To make easier the work with the collections panel, QElectroTech provides a search tool that makes faster finding elements inside the different collections.

## ***Selection properties panel***

The selection properties panel displays the properties from the selected object. Only the properties from some object can be displayed at the panel. The selection properties panel can display the properties from:

- [Elements](#)
- Some [basic objects](#): [line](#), [rectangle](#), [ellipse](#), [polygon](#) and [picture](#).

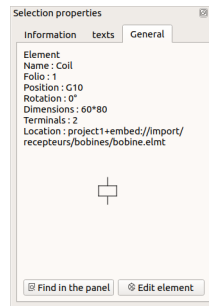

*Figure: QElectroTech selection properties panel*

To display or hidden the selection properties panel:

### 1. Select **Settings > Display > Selection properties** menu item.

The main function of the selection properties panel is to manage the object properties. At QElectroTech, the object properties can be different for each object. The main tasks that can be done from the selection properties panel are:

- Manage the properties from the basic geometrical objects ([line](#), [rectangle](#), [ellipse](#) and [polygon](#)).
- Define the scale from the imported [pictures](#).
- Lock the position of the [basic objects](#) ([line](#), [rectangle](#), [ellipse](#), [polygon](#) and [picture](#)).
- Manage the information from the [elements](#) (label, function, manufacturer, article number, order number, etc.).
- Manage the text and dynamic text from element symbols.
- Display the general element properties (name, position, dimensions, number of terminals, etc.).
- Manage the element links (cross references).

## ***Auto Numbering Selection panel***

The Auto Numbering Selection panel displays the active [auto numbering pattern](#) for:

- [Folio](#)
- [Element](#)
- [Conductor](#)

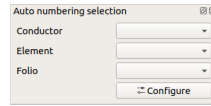

Figure: QElectroTech Auto Numbering Selection panel

To display or hidden the Auto Numbering Selection panel:

1. Select **Settings > Display > Auto Numbering Selection** menu item.

The main function from the Auto Numbering Selection panel is to manage [auto numbering patterns](#).

- Select the active folio auto numbering pattern
- Select the active element auto numbering pattern

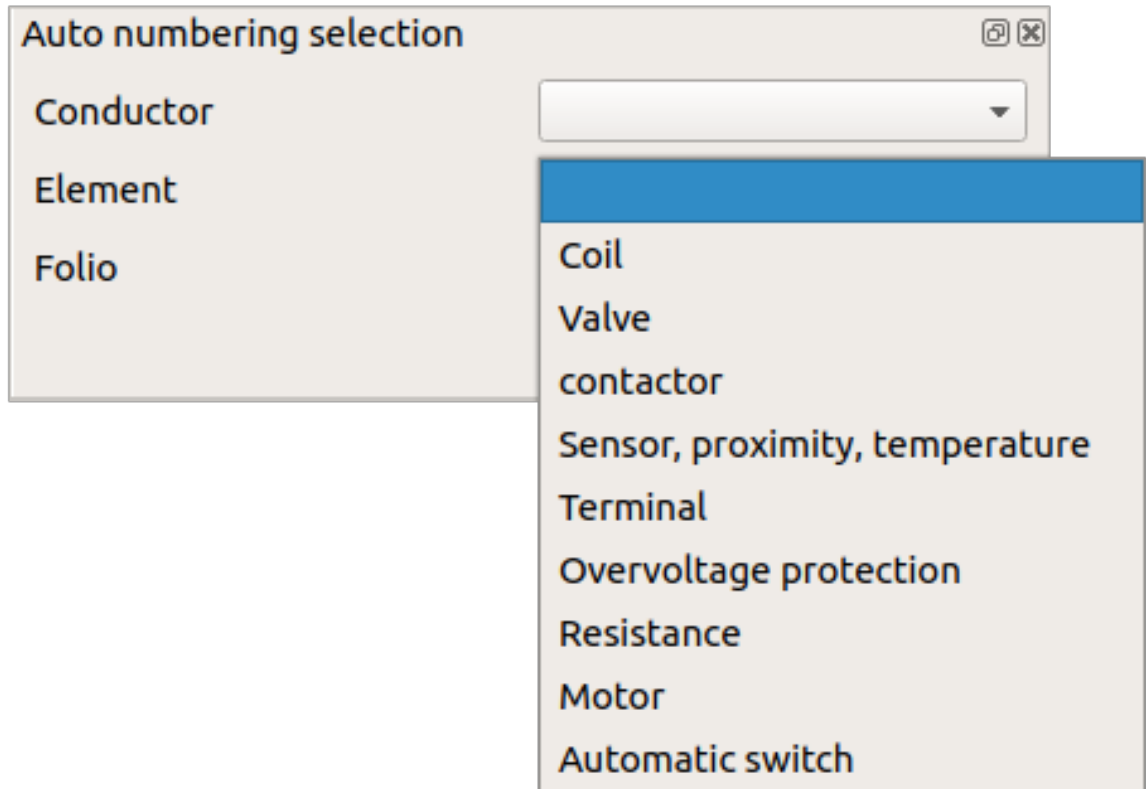

Figure: QElectroTech element pattern selection

- Select the active conductor auto numbering pattern

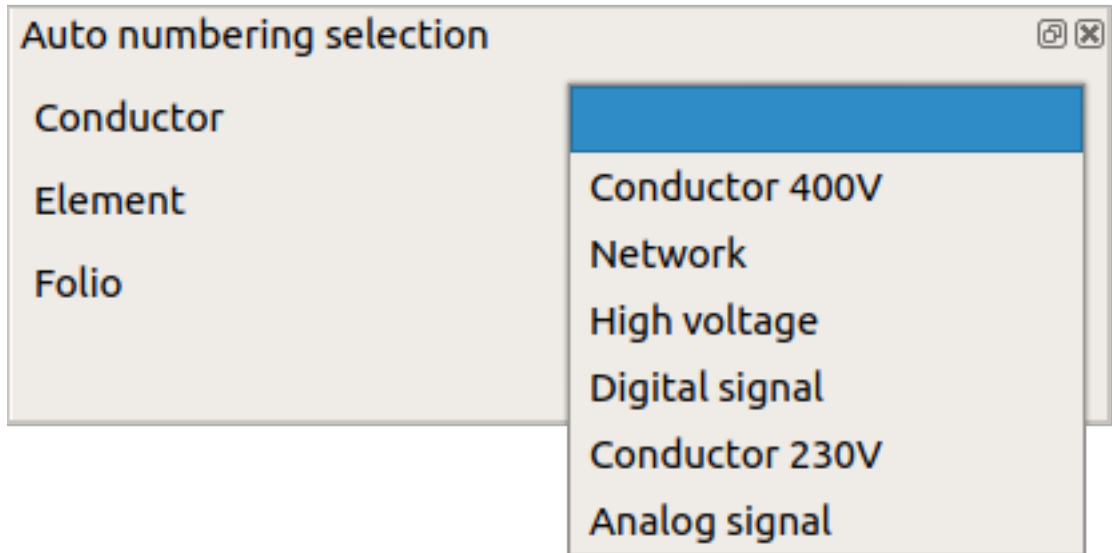

Figure: QElectroTech conductor pattern selection

#### Seealso

For more information about how to use the Auto Numbering Select panel during folio addition, refer to [add folio](#) section.

For more information about how to use the Auto Numbering Select panel during element addition, refer to [add element](#) section.

For more information about how to use the Auto Numbering Select panel during conductor creation, refer to [create conductor](#) section.

## Undo panel

The Undo panel displays the history since the last time that the document was saved. Once the [project](#) is saved, undo panel is automatically cleared.

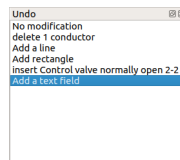

Figure: QElectroTech Undo panel

To display or hidden the undo panel:

1. Select **Settings > Display > Undo** menu item.

The undo panel is used to return the [project](#) to the status after one of the actions made after last save. By one click on one of the actions listed at undo panel, the [project](#) will return to the status after the action choosed at the panel. While the [project](#) is not saved again, the user can go to the different status as many times he wants.

### Warning

If you play with the panel, be sure that you are at the correct history status before continue working, saving [project](#) or any irreversible action like [delete folio](#). Once the [project](#) is saved or an irreversible action is made, the history is cleared.

Using the undo panel is interested for:

- Coming back some steps with a click.
- Recovering an object which was deleted some steps before. The object can be recovered coming back one step before the elimination, [copying the object](#), coming back to the last history status and [pasting the object](#).
- Checking the status from the [project](#) some steps before.
- Etc.

## Projects tabs bar

The different opened projects from QElectroTech can be managed using PopUP windows under the [menu bar](#) and [toolbars](#) or using a project tabs bar.

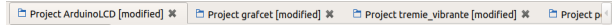

Figure: QElectroTech project tabs bar

### Note

- Select **Display > Display projects > Using windows** menu item to manage the projects by windows.
- Select **Display > Display projects > Using tabs** menu item to manage the projects by tabs bar.

The project tabs bar allows the following actions:

1. Choosing the active project by simple click on the tab.
2. Closing the project by using the close tab which can be found at the right side from each project tab.

## Folio tabs bar

The folio tabs bar can be considered part of the [workspace](#). The folio tabs bar contains one tab for each [folio](#) of the [project](#).

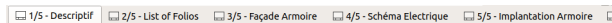



Figure: QElectroTech folio tabs bar

The folio tabs bar allows the following actions:

1. Choosing the active folio by simple click on the tab.
2. Opening the properties PopUP window from an specific folio by double click on the tab.
3. Adding new folio to the project by simple click on the **Add folio** icon  from right side.

## Help bar

The help bar, also known as information bar, is the space below control tabs, the bottom left corner from main window. It is very useful for beginners of QElectroTech in the way that it gives information about the field that is pointed by the cursor. A user can learn about a field by simply pointing it with the mouse and reading the information from help bar.

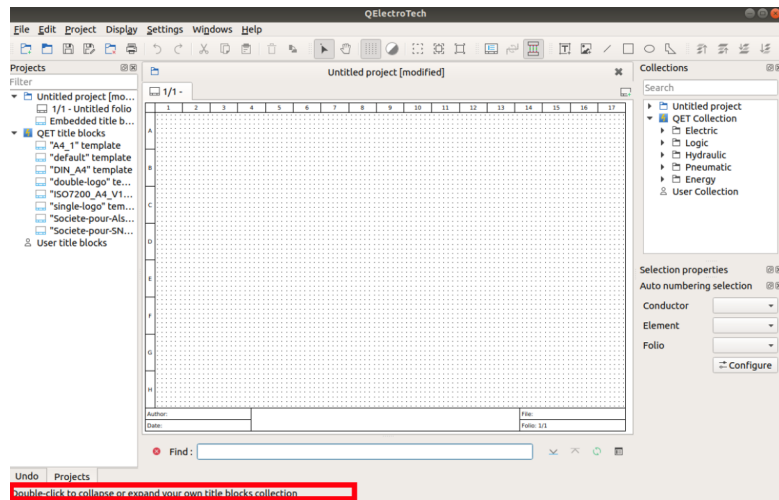

Figure: QElectroTech help bar

## Search menu

The search menu allows searching **elements**, **folios** or **conductors** which have a text field or property with an specific value. The search menu allows finding automatically an **element** with a desired label, list the **folios** from an specific author, etc.

QElectrotech provides a basic and simple search menu composed by a text box which allows writing the desired string which should be found and some buttons for closing the menu, actualizing the search and going to next and previous coincidence.



Figure: QElectroTech search menu

QElectroTech also provides an advanced menu where filters can be defined inside **folios**, **text fields**, **elements** and **conductors** trees. The advanced mode also allows replacing actions.

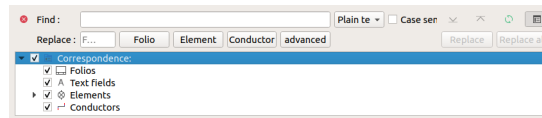

Figure: QElectroTech advanced search menu

To display or hidden the search menu:

1. Select **Edit > Search / Replace** menu item to display or hidden the search menu at the bottom from the **workspace**.

## Note

The search menu can also be displayed using **Ctrl + f** shortcut keyboard.

## GUI costumization

### Organize toolbars

The QElectroTech GUI allows having many different **toolbars** switched on to make more friendly the application.

To display or hide **toolbars**:

1. Select **Settings > Display** menu item to display the **panels** and **toolbars** list.

2. Click on the different **toolbars** (Tools, Display, Diagram, Add and Depth) which should be displayed or hidden.

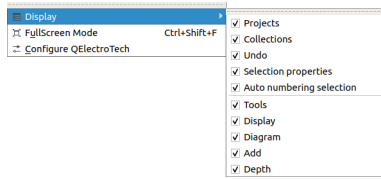

Figure: QElectroTech Settings > Display menu

All **toolbars** are placed by default under **menu bar**, in one row. The user is free reorganizing the **toolbars**. The **toolbars** can be organized in rows, columns at the left or right side from the **workspace** or as floating toolbar.

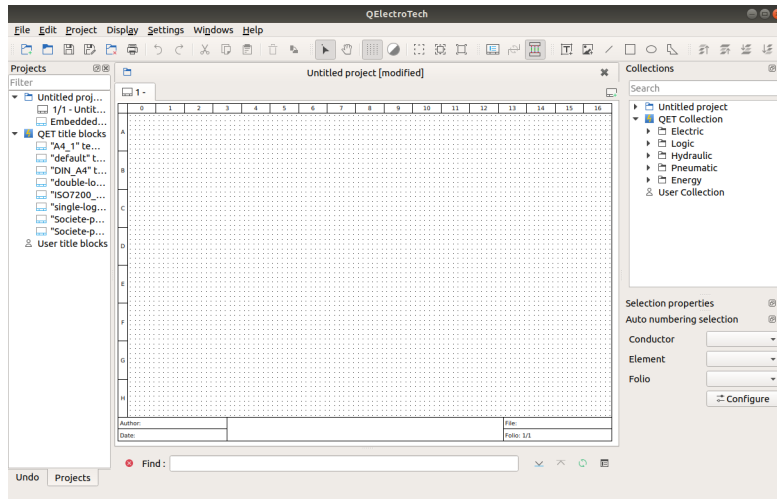

Figure: QElectroTech user interface

To change the organization of **toolbars**:

1. Left click at the left side from the **toolbar**.
2. Without releasing the **toolbar**, move the mouse to the final position.
3. Release the **toolbar**.



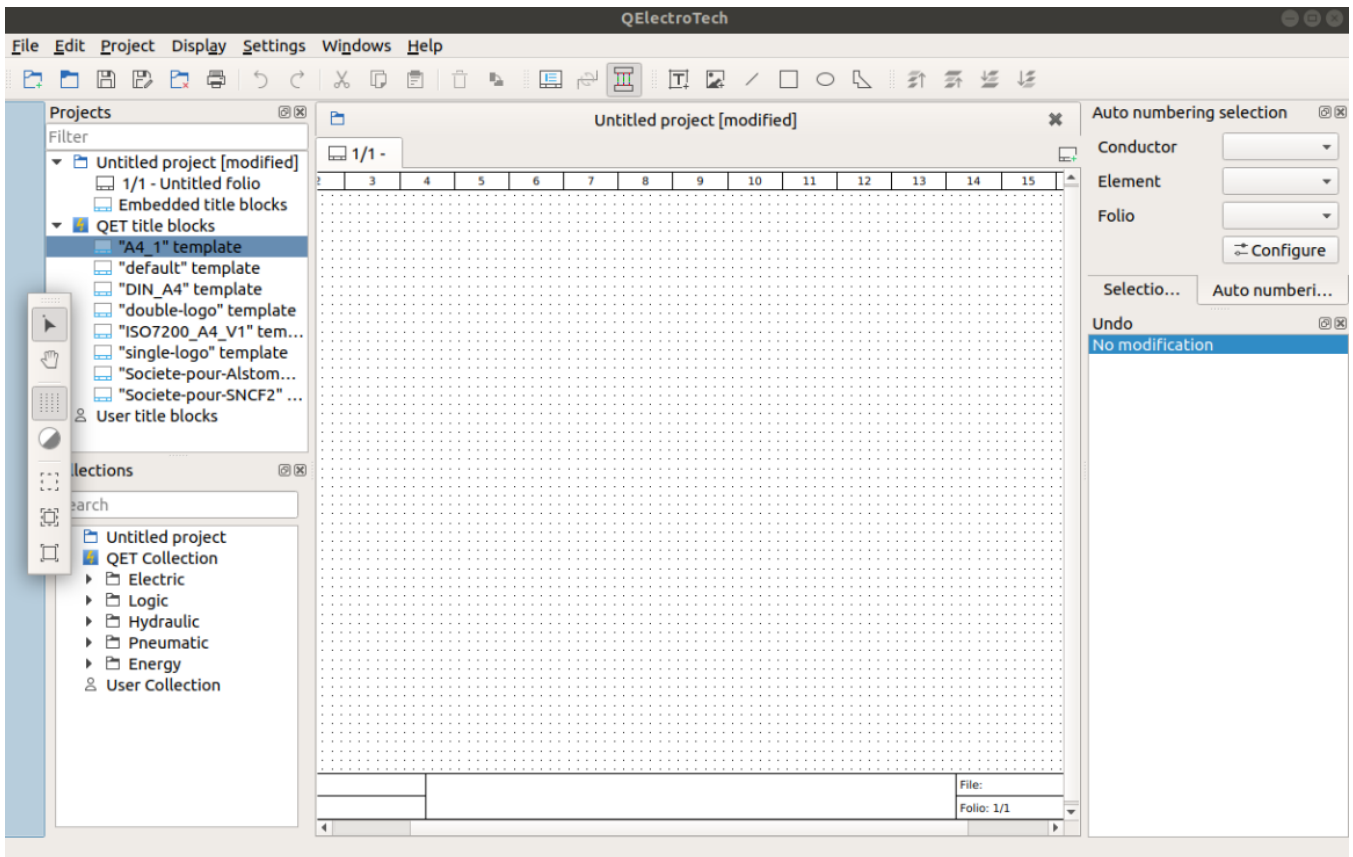

Figure: QElectroTech toolbars placement

## Organize panels

QElectroTech GUI has been designed to work using the **menu bar** and **panels**. The **menu bar** is fixed at top. The **panels** can be displayed and hidden.

To display or hide **panels**:

1. Select **Settings > Display** menu item to display the **panels** and **toolbars** list.
2. Click on the different **panels** (Projects, Collections, Undo, Selection properties and Auto numbering Selection) which should be displayed or hidden.

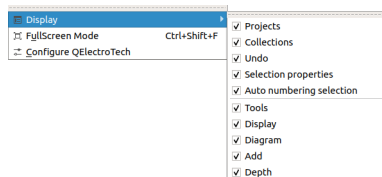

Figure: QElectroTech Settings > Display menu

All **panels** can be displayed at right and left side from **workspace**. The **panels** can be organized on column or by tabs. The **panels** can also be displayed as PopUp/floating windows.

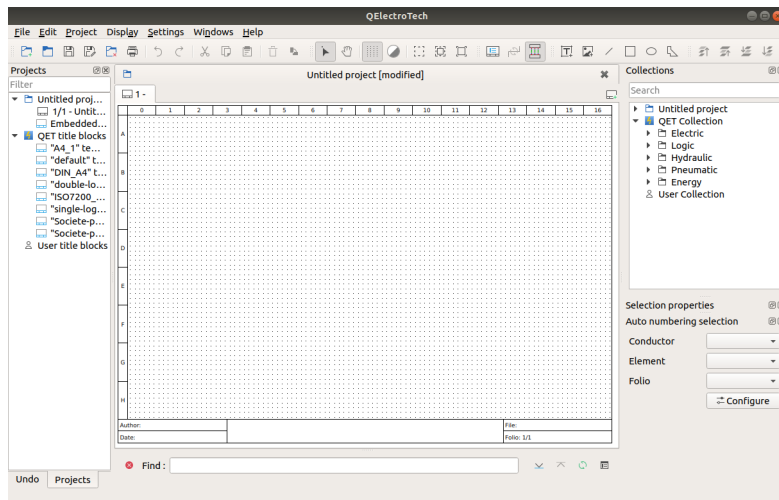

Figure: QElectroTech user interface

To change the organization of panels:

1. Left click at the title bar from the panel.
2. Without releasing the panel, move the mouse to the final position.
3. Release the panel.

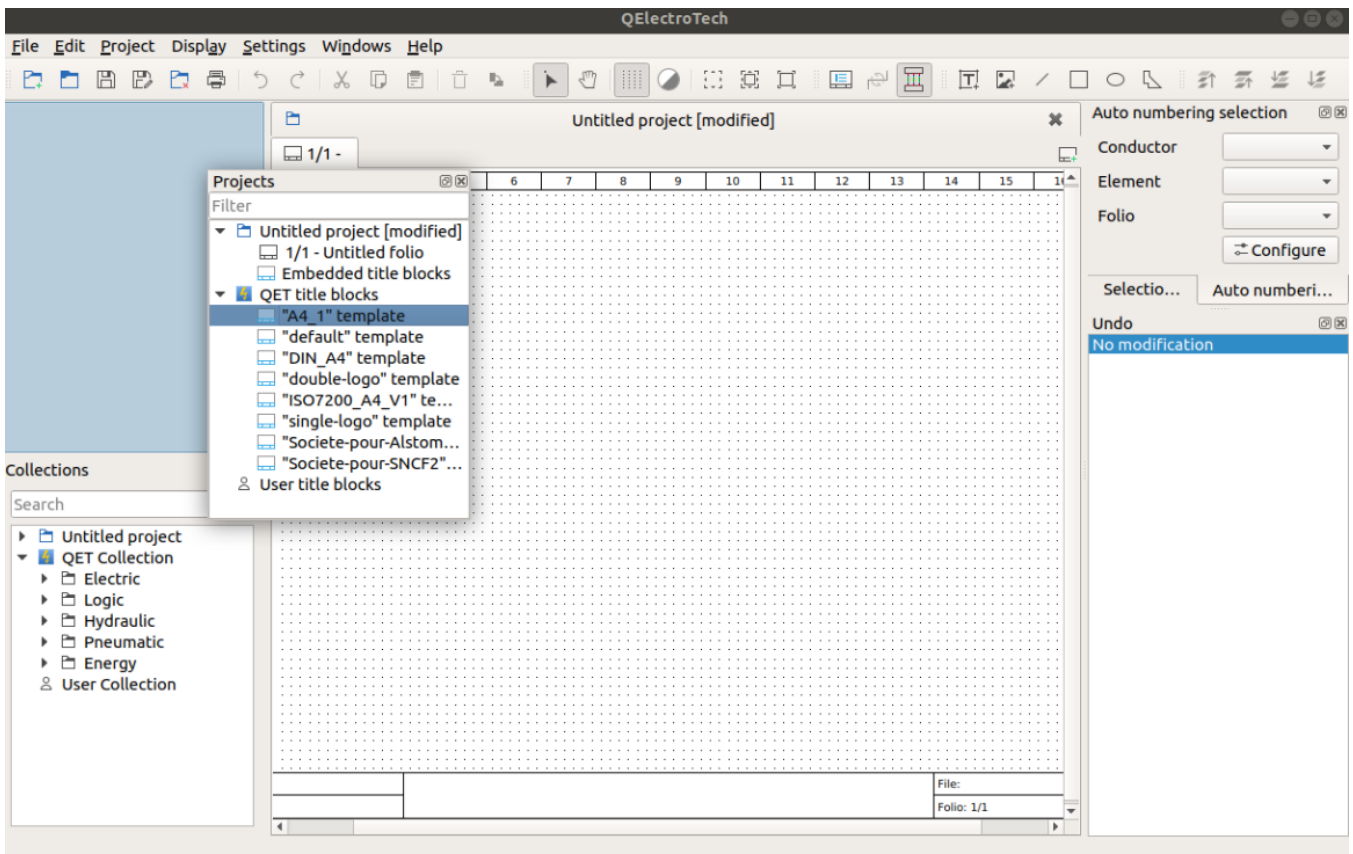

Figure: QElectroTech panels placement

## Project visualization

There is two different ways to manage the activation and hidden of opened projects. The projects can be organized with a project tabs bar displayed at top from the folio tabs bar or with floating windows that can be displayed or minimized.

To define the project visualization preference:

1. Select **Display > Display projects** menu item to display the project visualization options.

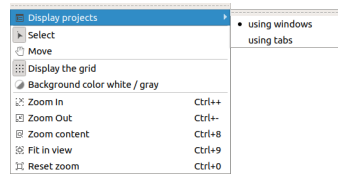

Figure: QElectroTech Display > Display projects menu

2. Click on the desired option: **using windows** or **using tabs**

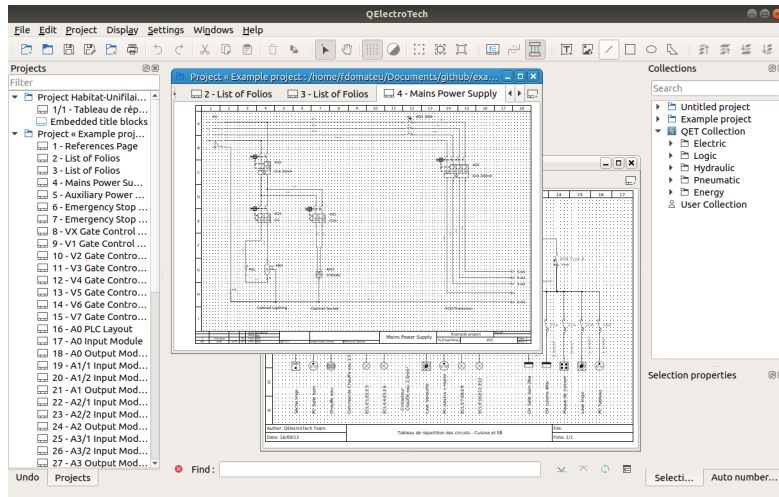

Figure: QElectroTech projects visualization using windows

**Seealso**

The project display preferences can also be defined at QElectroTech [appearance settings](#).

**Full screen mode**

QElectroTech provides the option of displaying full screen. The full screen mode can be selected from [menu bar](#) and using keyboard shortcut.

**Full screen mode from menu bar**

1. Select **Settings > FullScreen Mode** menu item to display QElectroTech in full screen mode.



Figure: QElectroTech settings menu

**Full screen mode using keyboard shortcut**

QElectroTech allows using keyboard shortcut to increase the working efficiency.

1. Press **Ctrl + Shift + f** to display QElectroTech in full screen mode.

**Seealso**

For more information about QElectroTech keyboard shortcut, refer to [menu bar](#) section.

## Note

To leave full screen mode, select **Settings > Leave FullScreen Mode** menu item or use again **Ctrl + Shift + f** keyboard shortcut.

## Preferences

### Display settings

QElectroTech allows the user customizing many settings: [language](#), [appearance](#), [export](#) and [printing](#) settings, pre-define [new project](#) settings, [element](#) collection paths, etc.

To display QElectroTech settings:

1. Select **Settings > Configure QElectroTech** menu item.

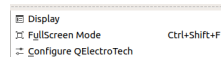

Figure: QElectroTech settings menu

### QElectroTech appearance

#### Project visualization

The default project visualization option can be defined at the appearance settings from QElectroTech. Select between:

- Use windows
- Use tabs

## Note

The changes are applied at the next launch, quit and launch again QElectroTech or follow the procedure from [customize project visualization](#).

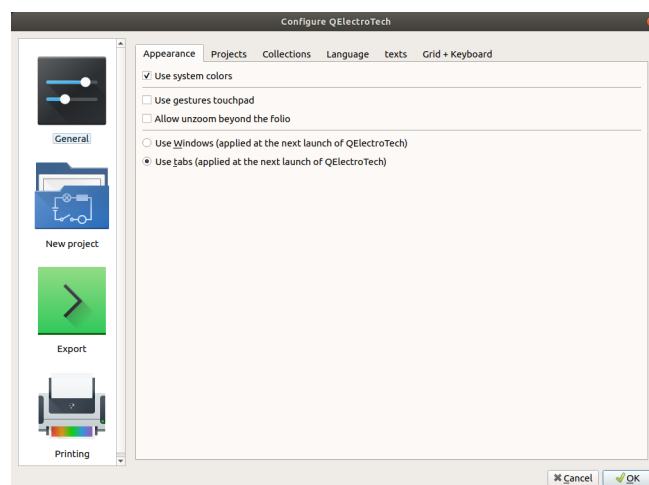

Figure: QElectroTech appearance settings

## Project settings

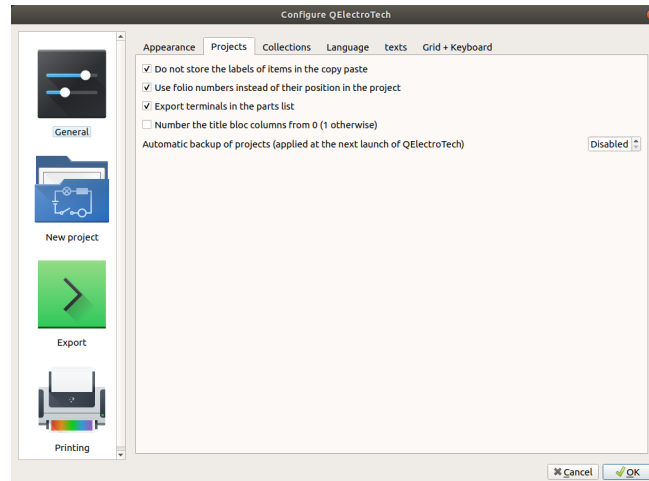

Figure: QElectroTech general project settings

## Element settings

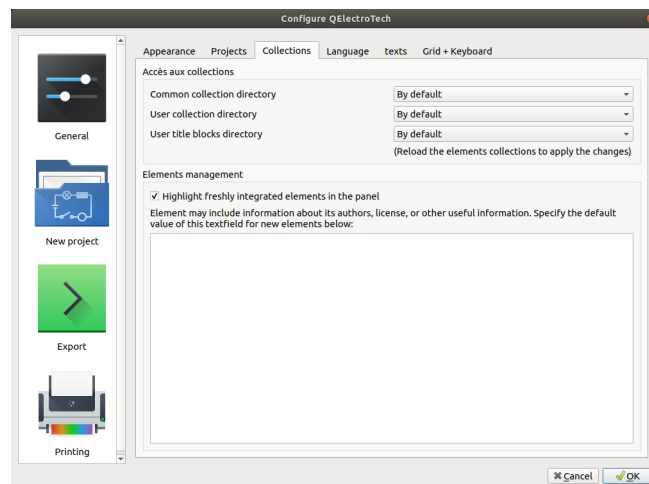

Figure: QElectroTech elements settings

## Collection settings

QElectroTech allows choosing the path from the **QET (Common)** and **User** element collection. The path from **User Title Block** collection can also be chosen. The collections directory can be at the local Hard Disk, common users, or at local servers, common for companies.

The default element collection paths depend on the installation settings chosen during the installation process.

### Example

<b>QET collection:</b>	<b>Windows:</b>	C/Program Files/QElectroTech/elements
	<b>Linux:</b>	/usr/share/qelectrotech/elements
	<b>Mac:</b>	
<b>User collection:</b>	<b>Windows:</b>	C/users/user_name/Application Data/qet/elements
	<b>Linux:</b>	/Home/user_name/QElectroTech/collections/elements
	<b>Mac:</b>	

For changing the element collection paths of QElectroTech:

1. [Display](#) QElectroTech settings PopUP window.
2. Go to **Elements** section.
3. Search and choose the folder directory from the [QET \(Common\)](#) and [User](#) element collection at the **Collection of elements** section.
4. Press **OK** button to save the configuration changes and close settings PopUP window.

### Note

QElectroTech has to be restarted to implement the changes.

### Element management settings

QElectroTech provides the possibility to predefine the [element author](#). In this way; when a new [element](#) is created, QElectroTech defines automatically this [element property](#).

For pre-defining the [element author](#) information:

1. [Display](#) QElectroTech settings PopUP window.
2. Go to **Elements** section.
3. Defines the element author and license information at the text box from **Elements management** section.
4. Press **OK** button to save the configuration changes and close settings PopUP window.

### Select language

QElectroTech is a multilanguage tool already translated to 21 languages.

To select the working language:

1. [Display](#) QElectroTech settings PopUP window.
2. Go to **General** section.
3. Go to **Language** tab.
4. Spread out the combo box and select the desired language.
5. Press **OK** button to save the configuration changes and close settings PopUP window.

### Note

The changes are applied at the next launch, [quit](#) and [launch](#) again QElectroTech.

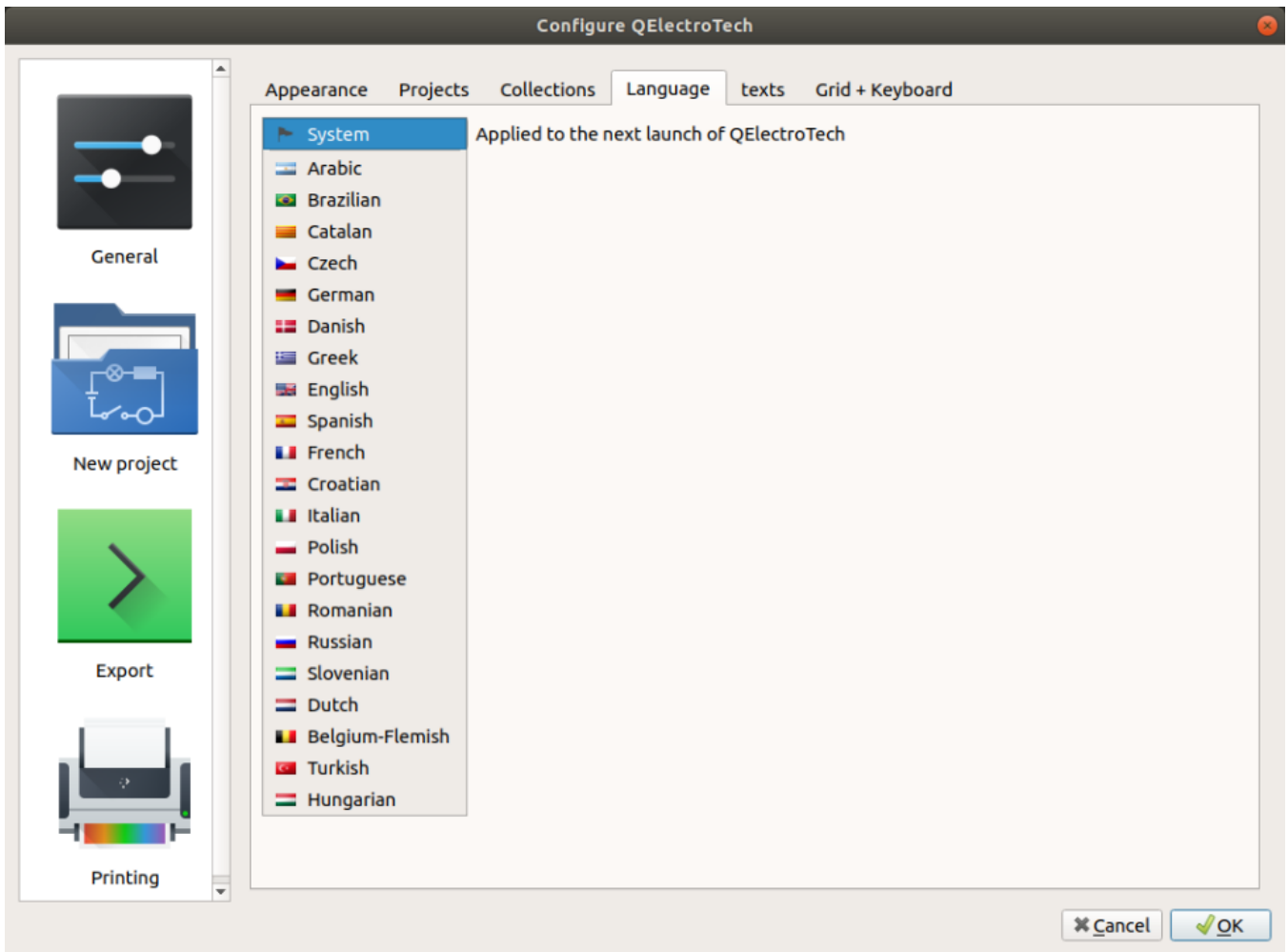

Figure: QElectroTech configure language section

## Text settings

Before starting to work, QElectroTech allows defining the default appearance of the different texts.

### Elements texts

### Independent texts

QElectroTech allows defining a default orientation and text font from the text field object.

1. Click at the button from the text font to display the [select font PopUp window](#).
2. Select a default rotation angle for the text.

### Note

Oposite to the geometrical angle, QElectroTech use the clock direction to define angles.



Figure: QElectroTech dynamic texts settings

## Summary pages

QElectroTech allows defining a default text font from the project summary table.

1. Click at the button from the text font to display the [select font PopUp window](#).

## Other texts

QElectroTech allows defining a default orientation and text font for the text that is not part from an element, text field object and from the project summary.

1. Click at the button from the text font to display the [select font PopUp window](#).

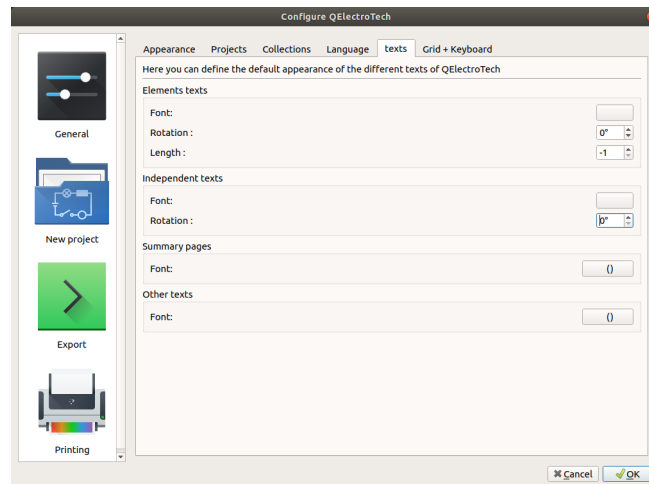

Figure: QElectroTech dynamic texts settings

## Grid settings

QElectroTech provides a grid displayer for the [workspace](#) which makes easier the drawing work.

To configurate the grid displayed:

1. [Display QElectroTech settings PopUP window](#).
2. Go to **General** section.
3. Go to **Grid + Keyboard** tab.
4. Define the X and Y pixels of the grid cell. The cell size can be between 1 and 30 pixels.

The number of grid cells displacement using the keyboard or the scroll bar can also be defined at the same section where the grid characteristics are defined. Standar and accurat scroll (with **ALT** key) can be defined.

### Seealso

To display the grid at the [workspace](#), refer to [toolbars](#) section.



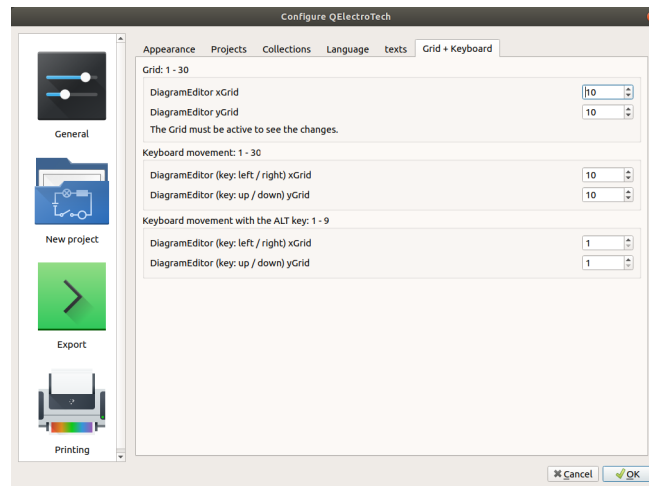

Figure: QElectroTech grid settings

## New project settings

### Folio settings

QElectroTech provides the option to storage at the Data from the application some **project properties** pre-defined by the user. This feature allows the user avoiding to define many **project properties** each time that the user **creates new projects**.

The **Folio** tab from **New project** settings section allows pre-defining some **folio properties**:

- Folio size.
- Folio title block.
- Folio default variables values.
- Folio user variables.

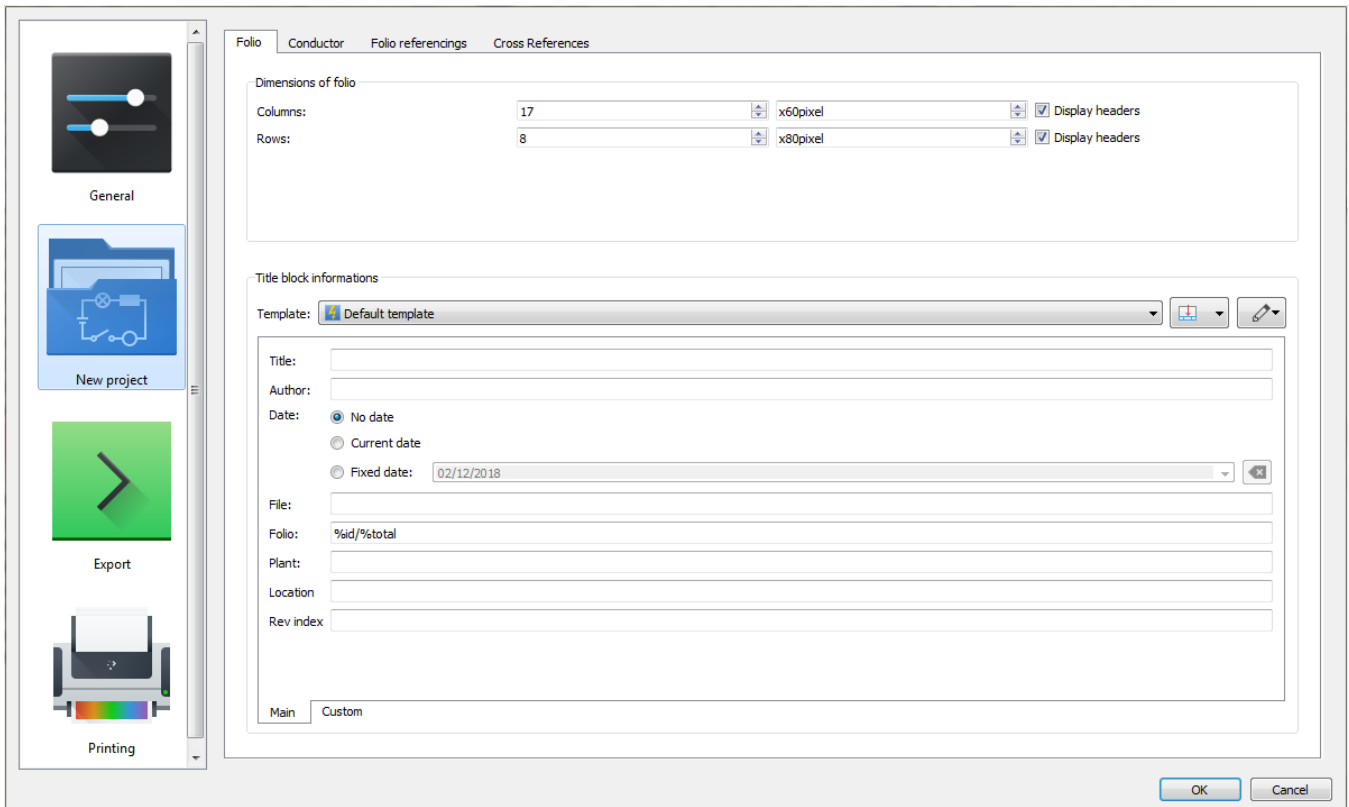

Figure: QElectroTech New project folio settings

To define folio settings:

1. Display QElectroTech settings PopUP window.
2. Go to **New project** section.
3. Go to **Folio** tab.
4. Define the desired parameters for each field.
5. Press **OK** button to save the configuration changes and close settings PopUP window.

### Note

All pre-defined **folio properties** defined at QElectroTech settings PopUP window will be automatically defined during **project creation** at **project properties**. The **folio properties** can be found at **Folio tab** from **New folio** section.

### Conductor settings

QElectroTech provides the option to storage at the Data from the application some **project properties** pre-defined by the user. This feature allows the user avoiding to define many **project properties** each time that the user **creates new projects**.

The **Conductor** tab from **New project** settings section allows pre-defining some **conductor properties**:

- Conductor type (Multiline or Single line).
- Conductor appearance.

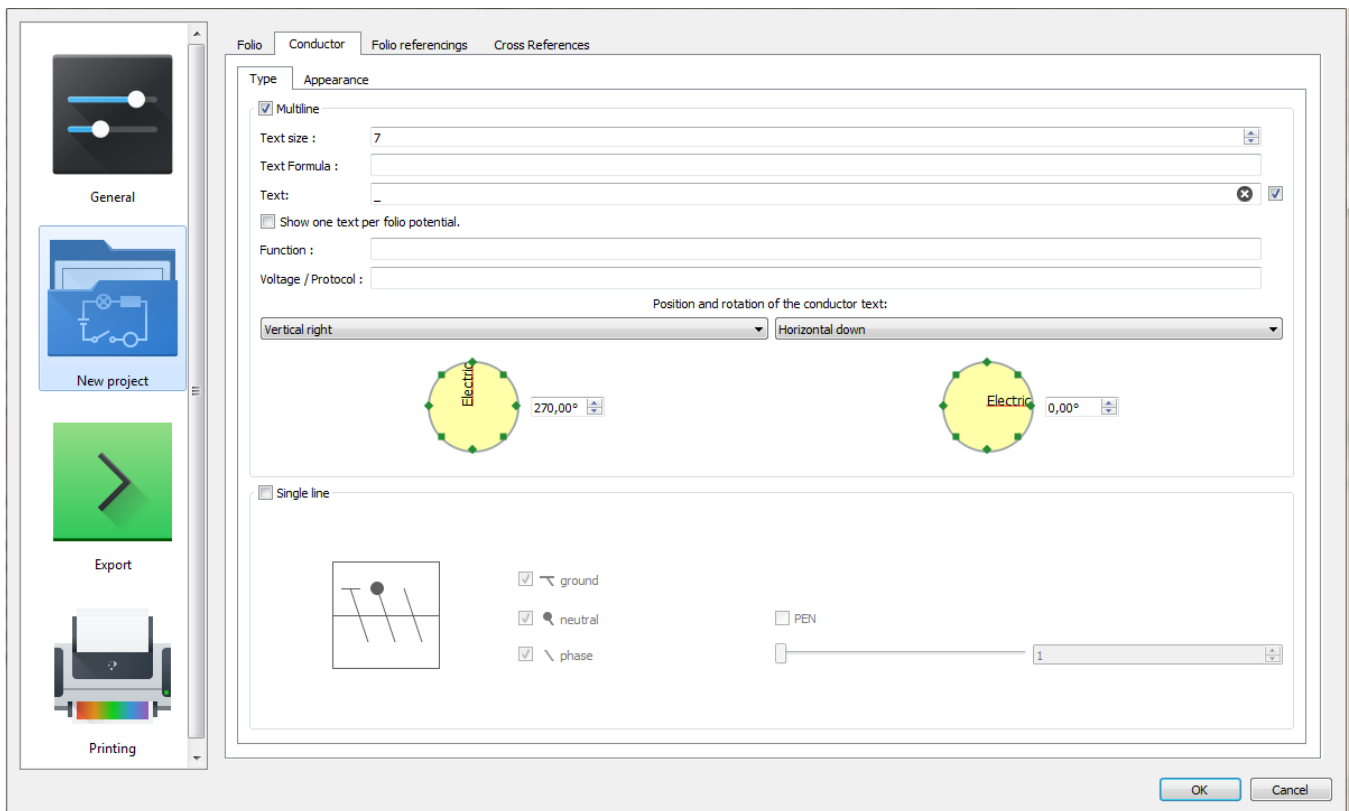

Figure: QElectroTech New project conductor settings

To define conductor settings:

1. Display QElectroTech settings PopUP window.

2. Go to **New project** section.
3. Go to **Conductor** tab.
4. Define the desired parameters for each field.
5. Press **OK** button to save the configuration changes and close settings PopUP window.

## Note

All pre-defined conductor properties defined at QElectroTech settings PopUP window will be automatically defined during [project creation](#) at [project properties](#). The [conductor properties](#) can be found at [Conductor tab](#) from [New folio](#) section.

## Folio referencings settings

QElectroTech provides the option to storage at the Data from the application some [project properties](#) pre-defined by the user. This feature allows the user avoiding to define many [project properties](#) each time that the user [creates new projects](#).

The **Folio referencings** tab from **New project** settings section allows pre-defining the formula which should define the label variable from [Reference folio following](#) and [Previous reference folio](#).

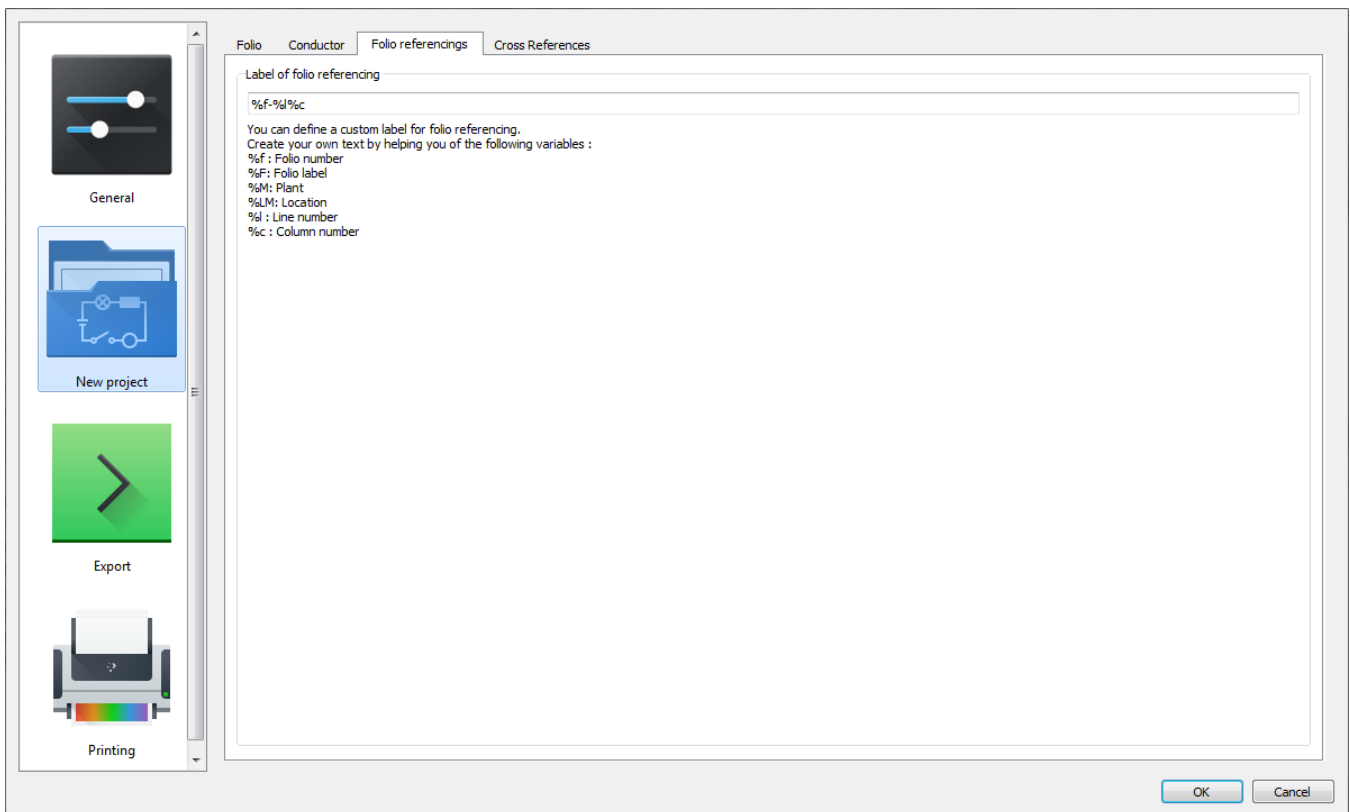

Figure: QElectroTech New project folio referencings settings

To define folio referencings settings:

1. [Display](#) QElectroTech settings PopUP window.
2. Go to **New project** section.
3. Go to **Folio referencings** tab.
4. Define the desired parameters for each field.
5. Press **OK** button to save the configuration changes and close settings PopUP window.

## Note

All pre-defined folio referencings properties defined at QElectroTech settings PopUP window will be automatically defined during [project creation](#) at [project properties](#). The folio referencings properties can be found at [Folio referencings tab](#) from [New folio section](#).

## Cross references settings

QElectroTech provides the option to storage at the Data from the application some [project properties](#) pre-defined by the user. This feature allows the user avoiding to define many [project properties](#) each time that the user [creates new projects](#).

The **Cross references** tab from **New project** settings section allows pre-defining some [cross references properties](#):

- Cross references type (Coil, organ of protection or Switch/button).
- Cross references label
- Representation position cross references label (Under the label of the element or Footer).

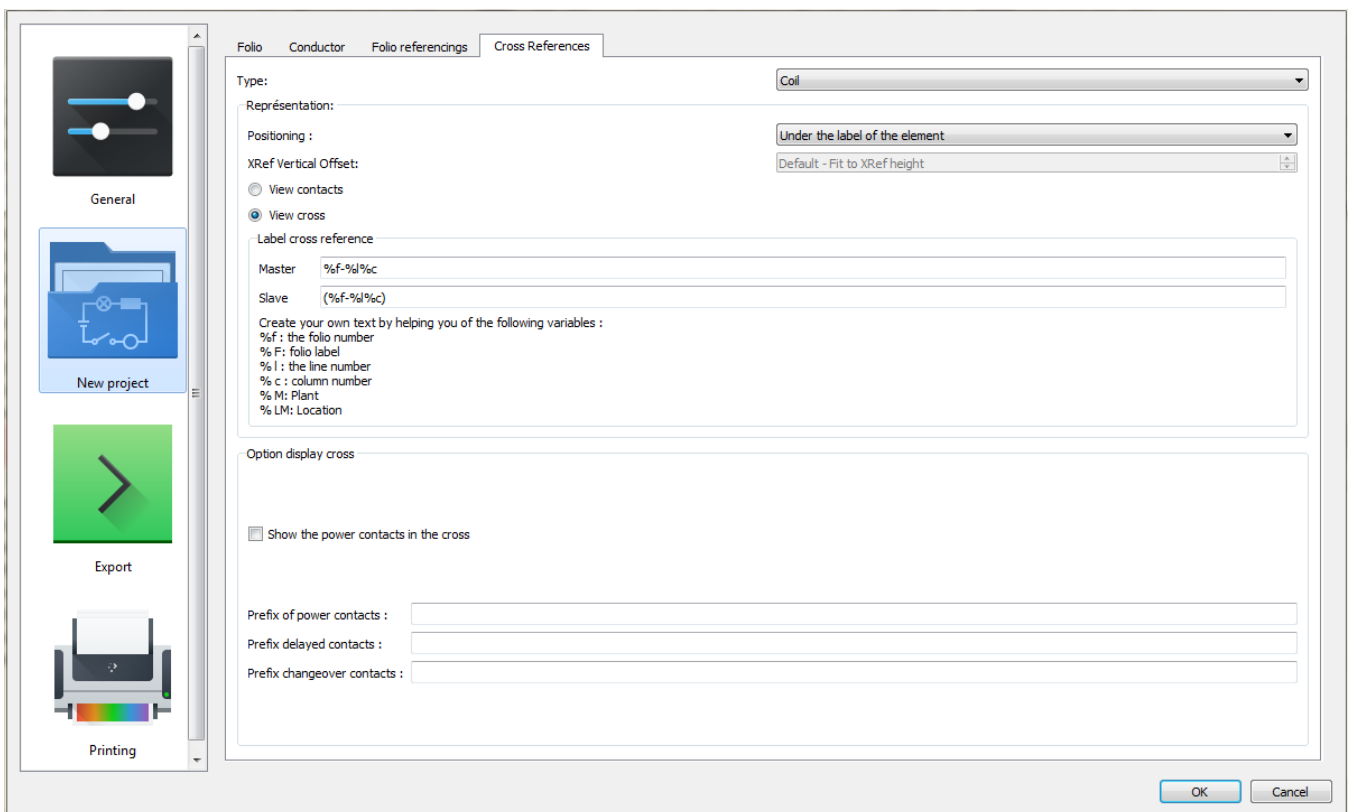

Figure: QElectroTech New project cross references settings

To define cross references settings:

1. [Display](#) QElectroTech settings PopUP window.
2. Go to **New project** section.
3. Go to **Cross references** tab.
4. Define the desired parameters for each field.
5. Press **OK** button to save the configuration changes and close settings PopUP window.

## Note

All pre-defined cross references properties defined at QElectroTech settings PopUP window will be automatically defined during [project creation](#) at [project properties](#). The cross references properties can be found at [Cross references tab](#) from [New folio](#) section.

## Export settings

QElectroTech allows predefining export settings for reducing the working configuration effort each time that a [project](#) have to be exported.

The default exporting settings which can be choosed are:

- Default target directory.
- Default exporting format (**PNG, JPEG, Bitmap, SVG** or **DXF**).
- **Default rendering options:**
  - Draw or not borders.
  - Title block.
  - Draw grid.
  - Draw terminals.
  - Keep conductor colors or monochrome.

To define default export settings:

1. [Display](#) QElectroTech settings PopUP window.
2. Go to **Export** section.
3. Select the desired setting values for each field.
4. Press **OK** button to save the configuration changes.

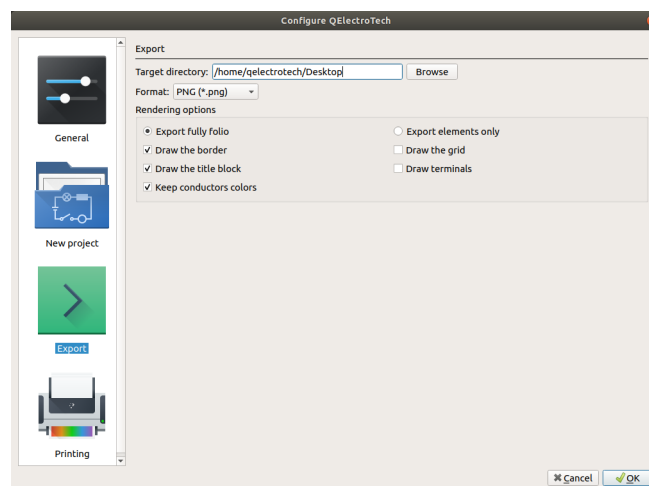

Figure: QElectroTech export settings

Seealso

For more information about QElectroTech export options, refer to [export](#) section.

## Printing settings

QElectroTech allows predefining printing settings for reducing the working configuration effort each time that a [project](#) have to be printed.

The default exporting settings which can be choosed are:

• **Default rendering options:**

- Draw or not borders.
- Title block.
- Draw grid.
- Draw terminals.
- Keep conductor colors or monochrome.

To define default printing settings:

1. [Display](#) QElectroTech settings PopUP window.
2. Go to **Printing** section.
3. Select the desired setting values for each field.
4. Press **OK** button to save the configuration changes.

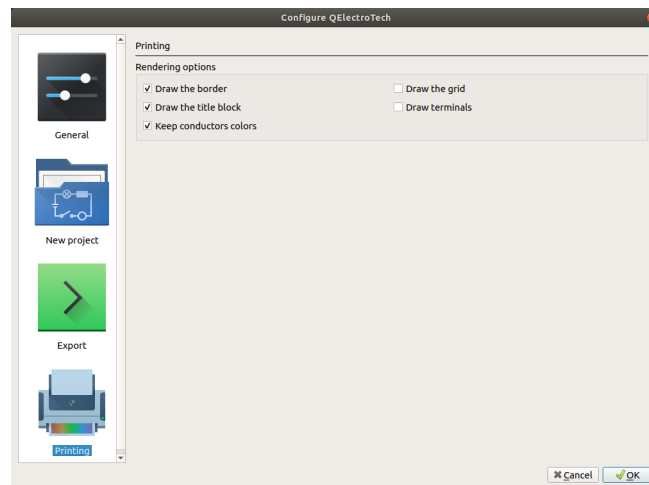

Figure: QElectroTech printing settings

Seealso

For more information about QElectroTech printing options, refer to [printing](#) section.

## Project

### What is a project?

The term project inside QElectroTech can be assimilated to a “dababase”. A project is not a common database, it is a collection of information which is not structured in columns and rows.

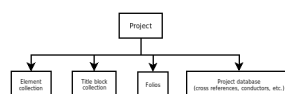

Figure: QElectroTech project structure

A project is a group of [folios](#), [elements](#) and [conductors](#) represented inside the [folios](#) with the respective properties, properties which define the way how should be represented each folio ([title block](#), dimensions, etc.), properties which define how the reports should be represented (folio index, component list, connector list, etc.), properties which

define how to export or print the information, interconnection relation between [elements](#) from the same or different [folios](#) and the master data (project name, author, year of creation, revision, etc.).

The project is the base of QElectroTech to manage a work. The development team has focus the tasks on the electrical and control filed, even so, QElectroTech is a E-CAE software. For this reason, QElectroTech is an inter-disciplinary tool that allows the user to create many type of projects.

- Electrical projects: Purely electrical systems
- Automation projects: GRAFCET, diagrams, etc.
- Fluid power projects: Hydraulic, pneumatic and central lubrication systems
- Proces control projects: Proces Industrial Diagrams (PID)

### Create new project

A new [project](#) can be created from [menu bar](#), [toolbar](#) and using the corresponding keyboard shortcut.

#### Create new project from menu bar

1. Select **File > New** menu item to create a new [project](#).

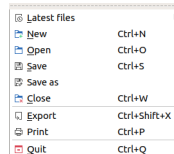

Figure: QElectroTech file menu

#### Create new project from toolbar

1. Select the icon  from [toolbar](#) to create a new [project](#).

#### Note

If the [toolbar](#) is not displayed, it can be displayed from **Settings > Display > Tools**

#### Create new project using keyboard shortcut

QElectroTech allows using keyboard shortcut to increase the working efficiency.

1. Press `Ctrl + n` to create a new [project](#).

#### Seealso

For more information about QElectroTech keyboard shortcuts, refer to [menu bar](#) section.

### Open Project

Opening a [project](#) saved somewhere from the computer Hard Disk or local server can be done from [menu bar](#), [toolbar](#) and using the corresponding keyboard shortcut.

A [project](#) is conformed by a single file with `.get` format. The `.get` extension is the native extension from QElectroTech. Even so, QElectroTech allows also working with Extensible Markup Language files, files with extension `.xml`.

## Open project from menu bar

1. Select **File > Open** menu item to open the search file PopUP window.

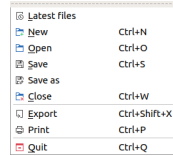



Figure: QElectroTech file menu

2. Search the [project](#) in the computer
3. Press **Open** button to close the search file PopUP window and open the [project](#).

## Open project from toolbar

1. Select the icon  from [toolbar](#) to open the search file PopUP window.
2. Search the [project](#) at the computer
3. Press **Open** button to close the search file PopUP window and open the [project](#).

### Note

If the [toolbar](#) is not displayed, it can be displayed from **Settings > Display > Tools**

## Open project using keyboard shortcut

QElectroTech allows using keyboard shortcut to increase the working efficiency.

1. Press `Ctrl + o` to open the search file PopUP window.
2. Search the [project](#) at the computer
3. Press **Open** button to close the search file PopUP window and open the [project](#).

### Seealso

For more information about QElectroTech keyboard shortcuts, refer to [menu bar](#) section.

## Files history

When QElectroTech has already been used, exists the possibility to open a [project](#) created, opened and/or saved previously. **File History** has been integrated.

1. Select **File > Latest files** menu item to display the file history from QElectroTech.
2. Click on the [project](#) file that should be opened.



Latest files			
New	Ctrl+N	/home/ ...	/Documents/github/project_template.get
Open	Ctrl+O	/home/ ...	/Documents/github/examples-qelectrotech/affuteuse_250h.get
Save	Ctrl+S	/home/ ...	/Documents/github/examples-qelectrotech/m_000.get
Save as		/home/ ...	/Documents/github/examples-qelectrotech/schema_indus.get
Close	Ctrl+W	/home/ ...	/Documents/github/examples-qelectrotech/industrial.get
Export	Ctrl+Shift+X	/home/ ...	/Documents/github/examples-qelectrotech/741.get
Print	Ctrl+P	/home/ ...	/Documents/github/examples-qelectrotech/Habitat-Unifilaire.get
Quit	Ctrl+Q	/home/ ...	/Documents/github/examples-qelectrotech/perceuse.get
		/home/ ...	/Documents/github/examples-qelectrotech/tremie_vibrante.get
		/home/ ...	/Documents/github/examples-qelectrotech/grafcet.get

Figure: QElectroTech File History

## Save Project

The current [project](#) can be saved from [menu bar](#), [toolbar](#) and using the corresponding keyboard shortcut.

One [project](#) is conformed by a simple file with `.get` format. The `.get` extension is the native extension from QElectroTech.

### Save project from Menu bar

1. Select **File > Save** menu item to save the active [project](#).

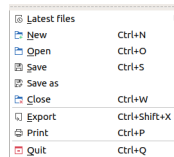

At the case that the [project](#) has already been saved and wants to be saved as a different [project](#), different name and/or directory:

1. Select **File > Save as** menu item to save the active [project](#) as a new [project](#).

### Save project from toolbar

1. Select the icon  from [toolbar](#) to save the active [project](#).

At the case that the [project](#) has already been saved and wants to be saved as a different [project](#), different name and/or directory:

1. Select the icon  from [toolbar](#) to save the active [project](#) as a new [project](#).

## Note

If the [toolbar](#) is not displayed, it can be displayed from **Settings > Display > Tools**

### Save project using keyboard shortcut

QElectroTech allows using keyboard shortcut to increase the working efficiency.

1. Press `Ctrl + s` to save the active [project](#).

Seealso

For more information about QElectroTech keyboard shortcuts, refer to [menu bar](#) section.

## Note

QElectroTech allows creating backup from [project](#) periodically. This option should be configured at **Settings > Configure QElectroTech > Projects**.

## Close Project

The user can close a [project](#) at any time. If the current work wants to be saved before closing the project, refer to [save](#) section. Even so, QElectroTech display an automatic message to [save project](#) if any modification has been created on it.

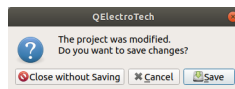

Figure: QElectroTech Save message

Closing the current project can be done from [menu bar](#), [toolbar](#), [projects panel](#), [projects tab bar](#) and using the corresponding keyboard shortcut.

At the case that more than one [project](#) are opened, the active [project](#) will be the [project](#) which will be closed.

### Close project from menu bar

1. Select **File > Close** menu item to close the active [project](#).

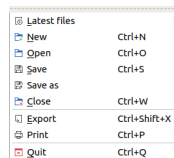

Figure: QElectroTech File menu

### Close project from toolbar

1. Select the icon  from [toolbar](#) to close the active [project](#).

## Note

If the [toolbar](#) is not displayed, it can be displayed from **Settings > Display > Tools**.

### Close project from projects panel

The advantage of closing [projects](#) from [projects panel](#) is the possibility to close [projects](#) which are opened and are not the active [project](#).

1. Right click on the opened [project](#) from the [projects panel](#) tree which should be closed.
2. Select **Close this project** to close the selected [project](#).

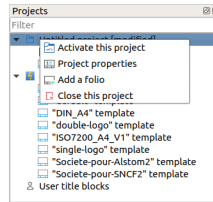



Figure: QElectroTech projects panel

## Note

If the [projects panel](#) is not displayed, it can be displayed from **Settings > Display > Projects**.

## Close project from projects tabs bar

All opened [projects](#) can be visible at the [projects tab bar](#) that is displayed at top from the [workspace](#). The user can close an opened [projects](#), regardless of whether the project is active, with a click on the close tab  from the project tab.

At the case that the [projects](#) are displayed as PopUP windows, they can be closed with a click on the close tab  which is placed at the top right corner.

## Note

Displaying the [projects](#) using a tab bar or using PopUP windows can be choosed at **Display > Display projects**.

## Close project using keyboard shortcut

QElectroTech allows using keyboard shortcut to increase the working efficiency.

1. Press `Ctrl + f4` to close the active [project](#).

### Seealso

For more information about QElectroTech keyboard shortcuts, refer to [menu bar](#) section.

## Clean project

QElectroTech stores on the project database every [title block](#), [conductor](#), [element](#), etc. which is introduced by the user. If the user deletes one [element](#) or replace the [title block](#) from the [folio](#), the [element](#) or [title block](#) will be deleted from the [folio](#) but it will still be storage at the project database.

QElectroTech allows cleaning the project database from [menu bar](#).

1. Select **Project > Clean project** menu item to open the cleaning project PopUP window.

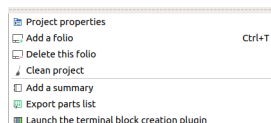
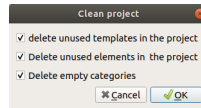

Figure: QElectroTech cleaning project PopUP window

2. Select the check buttons desired (templates, elements, categories).
3. Press the button **OK** to clean the [project](#) and close the cleaning project PopUP window.



### Note

Cleaning the [project](#) is recommended to reduce the size of the project file and increase the loading speed.

## Project properties

### Display project properties

The [project properties](#) can be displayed in a PopUP window from [menu bar](#) and [projects panel](#).

### Project properties from menu bar

1. Select **Project > Project properties** menu item to display the [project properties](#) PopUP window from the active project.

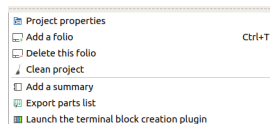

Figure: QElectroTech project menu

### Warning

If more than one [projects](#) is opened, be sure that the active [projects](#) is the correct before changing properties.

### Project properties from project panel

The advantage of displaying the [project properties](#) from [projects panel](#) is the possibility to choose [projects](#) which are opened and are not the active [project](#).

1. Right click on the [project](#) from the tree of the [projects panel](#).
2. Select **Project properties** to display the [project properties](#) PopUP window.

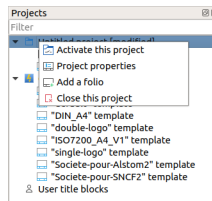

Figure: QElectroTech projects panel

### Note

If the [projects panel](#) is not displayed, it can be displayed from **Settings > Display > Projects**.

## General properties

The general properties section from [project properties](#) PopUP windows is the area where the user can define global project variables that later on can be used at the [folios title block templates](#) to automate the filling of the [title block](#).

Creating general project variables is recommended, it increases the working efficiency. The variables that can be found by default are:

- **% {projecttitle}**: Project title
- **% {saveddate}**: File saving date
- **% {savedfilename}**: Registered file name
- **% {savedfilepath}**: Saved file path
- **% {savedtime}**: File saving time

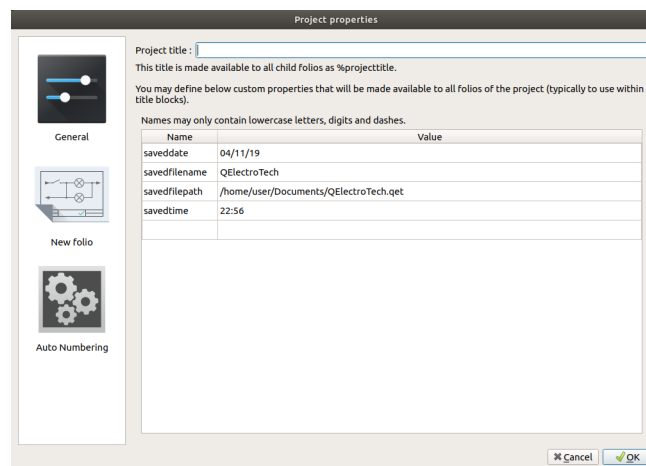

Figure: General project properties window

To create a new project variable:

1. [Display project properties](#) PopUp window.
2. Go to **General** project properties section.
3. Define the variable name at the left cell from the last row of the project variables table.
4. Define the value of the variable at the right cell from the variable row.
5. Press the button **OK** to save the changes and close the PopUp window.

Seealso

For more information about QElectroTech default variables, refer to [default QElectroTech variables](#) section.

## New folio properties

### Folio properties

At QElectroTech, the [folio properties](#) can be common at all [folios](#) from the same [project](#). QElectroTech also allows that each [folio](#) has its own properties. For example, two [folios](#) from the same project will have the same size and title block but they can be created by different authors or they can have different revision.

To increase the working efficiency, QElectroTech provides the option to storage at the project Data some [project properties](#) pre-defined by the user. This feature allows the user avoiding to define many [folio properties](#) each time that the user [creates new folio](#) inside the [project](#).

## Note

QElectroTech allows defining automatically [folio properties](#) during [project creation](#). For more information about how to standarize some [folio properties](#) from [project to project](#), please refers to the [QElectroTech folio settings](#) section.

The **Folio** tab from **New folio** settings section allows pre-defining some [folio properties](#):

- [Folio size](#).
- [Folio title block](#).
- [Folio default variables values](#).
- [Folio user variables](#).

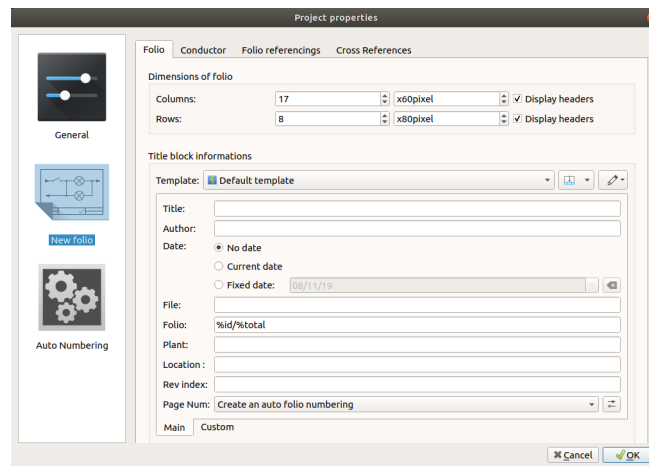

Figure: Project folio properties window

To define folio properties:

1. [Display](#) project properties PopUP window.
2. Go to **New folio** section.
3. Go to **Folio** tab.
4. Define the desired parameters for each field.
5. Press **OK** button to save the configuration changes and close project properties PopUP window.

## Note

All pre-defined [folio properties](#) at [project properties](#) will be automatically defined during [folio creation](#) at [folio properties](#).

## Conductor properties

Some [conductor properties](#) can be common at all or gran part of [conductors](#) from all or gran part of [folios](#). For example, the [conductor type](#) is normally common for a complete [project](#) or for a group of [folios](#).

To increase the working efficiency, QElectroTech provides the option to storage at the project Data some [project properties](#) pre-defined by the user. This feature allows the user avoiding to define many [conductor properties](#) each time that the user [creates new conductor](#) inside the [project](#).

## Note

QElectroTech allows defining automatically [conductor properties](#) during [project creation](#). For more information about how to standardize some [conductor properties](#) from [project to project](#), please refer to the [QElectroTech conductor settings](#) section.

The **Conductor** tab from **New folio** settings section allows pre-defining some [conductor properties](#):

- [Conductor type](#) (Multiline or Single line).
- [Conductor appearance](#).

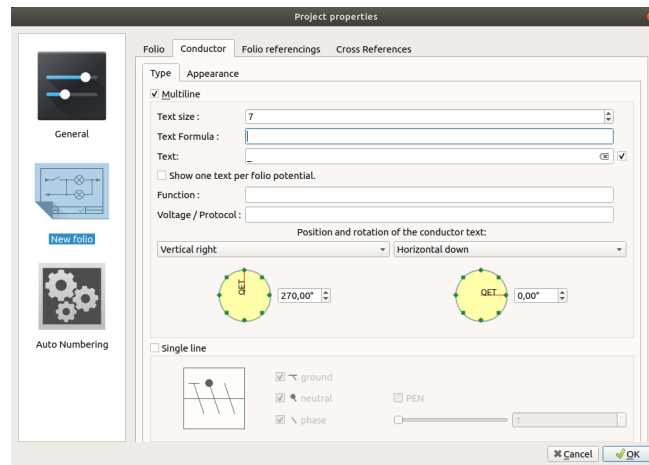

Figure: Project conductor properties window

To define conductor settings:

1. [Display](#) project properties PopUP window.
2. Go to **New folio** section.
3. Go to **Conductor** tab.
4. Define the desired parameters for each field.
5. Press **OK** button to save the configuration changes and close project properties PopUP window.

## Note

All pre-defined [conductor properties](#) at [project properties](#) will be automatically defined during [folio creation](#) at [folio properties](#).

## Folio referencing properties

QElectroTech allows creating schemas with multiple [folios](#), only part of the [schmea](#) is represented at each [folio](#). This means that part of a [conductor](#) can be at one [folio](#) and the continuation at a different [folio](#).

QElectroTech provides folio referencing elements to indicate from where a [conductor](#) is coming or where it is going. These [elements](#) can display at the [workspace](#) from the [folio](#) some information about the folio referencing element linked. The information which should be displayed can be defined by the user at **Folio referencing** tab from **New Folio** section of the [project properties](#).

### Seealso

For more information about folio referencing, refer to [Reference folio following](#) and [Previous reference folio](#).

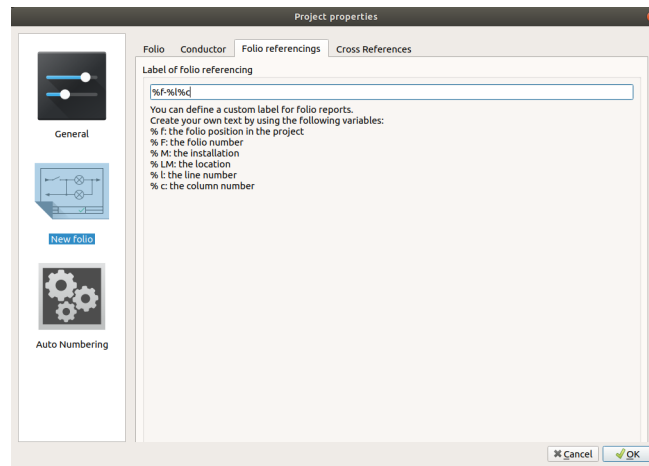

Figure: Project folio referencings properties window

To define folio referencings Label:

1. **Display** project properties PopUP window.
2. Go to **New folio** section.
3. Go to **Folio referencings** tab.
4. Define the desired parameters for each field.
5. Press **OK** button to save the configuration changes and close project properties PopUP window.

### Cross references properties

The main advantage of using **Master** and **Slave** elements is the possibility to create **cross references (links)** between **elements**. At the case of **cross references definition**, QElectroTech provides the possibility to display automatically at the **workspace** some information from the **Master** or **Slave** element linked.

The definition or cross references properties inside a project can be customized by the user at **project properties**.

#### Note

QElectroTech allows defining automatically **cross references properties** during **project creation**. For more information about how to standardize some **cross references properties** from **project to project**, please refers to the **QElectroTech cross references settings** section.

The **Cross references** tab from **New folio** settings section allows pre-defining some **cross references properties**:

- Cross references **Master element** type (Coil, organ of protection or Switch/button).
- Cross references label (Master and slave cross references label to be display at the **workspace**)
- Representation position from the cross references label (Under the element label or Footer).
- Display option from **cross references**

#### Note

The cross reference label can be created using the general variables from **Master** and **Slave** elements.



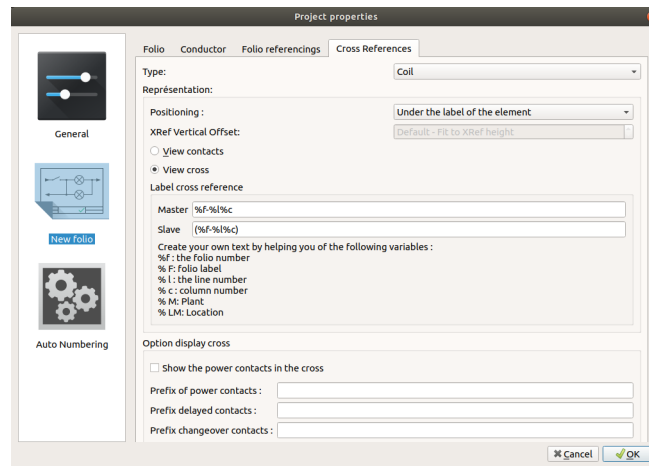

Figure: Project cross referencing properties window

To define cross references settings:

1. **Display** project properties PopUP window.
2. Go to **New folio** section.
3. Go to **Cross references** tab.
4. Define the desired parameters for each field.
5. Press **OK** button to save the configuration changes and close project properties PopUP window.

### Note

All pre-defined cross references properties defined at QElectroTech settings PopUP window will be automatically defined during **project creation** at **project properties**. The cross references properties can be found at **Cross references** tab from **New folio** section.

### Auto numbering properties

For managing projects during manufacturing, erection, commissioning and maintenance phase; a codification criteria has to be defined in the engineering phase, otherwise, the work is uneficient and the project a caos.

QElectroTech allows defining auto numbering patterns in the project properties for the codification of **elements**, **conductors** and **folios**.

Every time that a new folio is added to the **project** or an **element** or **conductor** is drawn in the **workspace**; the **folio**, **element** or **conductor** is codificated according to the selected patter in auto numbering selection panel.

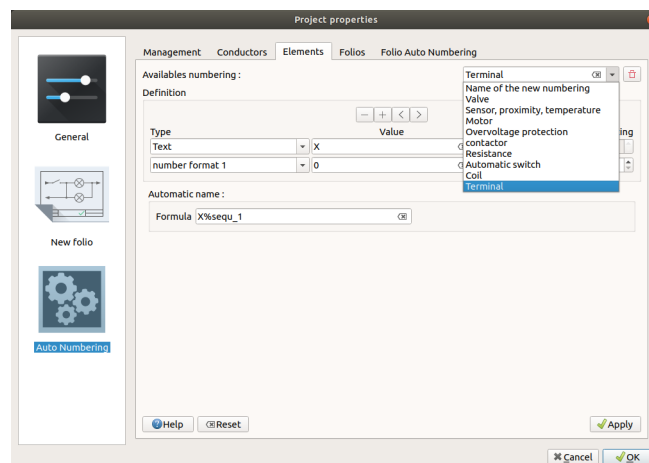



Figure: Project management properties window

**Display auto numbering properties from menu bar**

1. Select **Project > Project properties** menu item to display the project properties PopUp window.
2. Go to **Auto Numbering** project properties section.
3. Go to **Conductor, Element** or **Folio** tab to display the desired auto numbering patterns.

**Display auto numbering properties from panel**

The project auto numbering properties can be displayed from [auto numbering selection panel](#).

1. Press  **Configure** button from [auto numbering selection panel](#) to display **Auto Numbering** project properties section at a PopUp window.
2. Go to **Conductor, Element** or **Folio** tab to display the desired auto numbering patterns.

**Note**

If the [auto numbering selection panel](#) is not displayed, it can be displayed from **Settings > Display > Selection properties**.

## Seealso

For more information about auto numbering pattern definition refer to:

- Folio numbering section
- Conductor numbering section
- Element numbering section

**Folio****What is a folio?**

A **folio** is part of the **project** that can be considered as a unit. It can be the **project index**, part of the **schema**, the part list complete or partly, etc.

The **folio** defines the maximum part of the project information that can be displayed at the same time in the **workspace**, a **folio** from a **project** is equivalent to a page of a book. When a **project** is exported to PDF, each **folio** is one page from the document. When a **project** is exported to any other format (PNG, JPG, DXF, etc.), each **folio** is one file.

Inside a **project**, the **folios** should have an order. For an easy understanding of the **schema**, it is important that the user takes care about the position and information that is included at each **folio**.

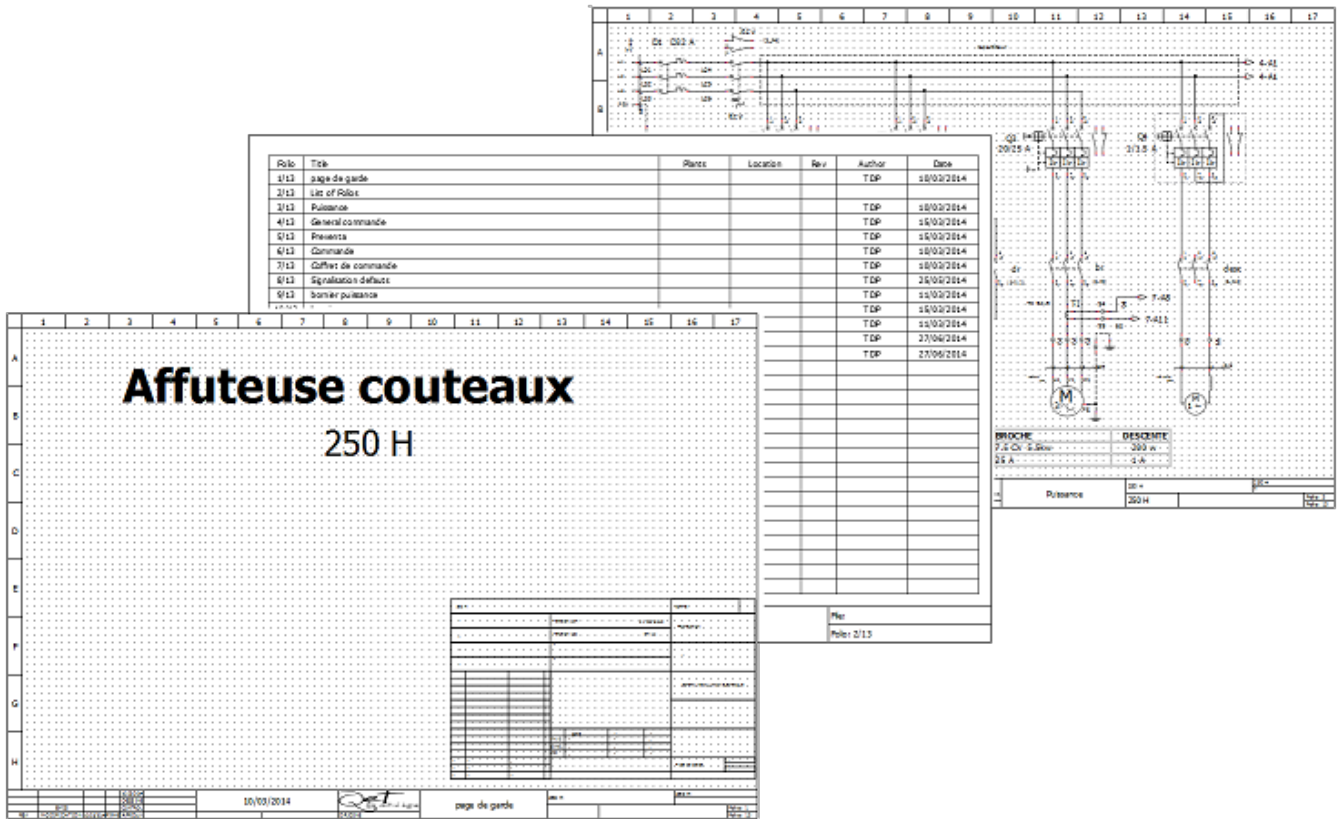

Figure: QElectroTech folios

## Type of folio

## Single line diagram

The single line diagrams represent electric, fluid, etc. systems using a simplified notation.

Single line conductors are used to draw single line diagrams.

## Note

At electric schemas, the power system is represented with a simplified notation and the control system is not represented. The **conductors** only represent power cables.

At fluid power schemas, the pressure and return line are represented by the same **conductor**.

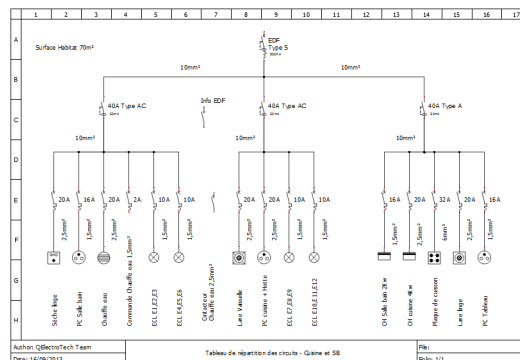

Figure: Single line diagram

### Multiline diagram

The multiline diagrams represent electric, fluid, etc. systems including all details: terminals, all phases, power and control system, etc.

Multiline conductors are used to draw single line diagrams.

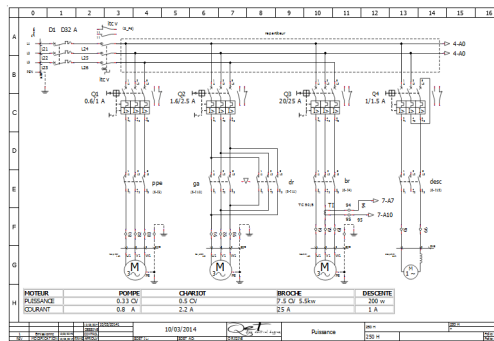

Figure: Multiline diagram

### Control diagram

A control diagram is a representation of the logic from a system, it is a model of the process to automate considering inputs, actions to be carried out and the intermediate processes that cause these actions.

Single line conductors are used to draw control diagrams.

### Note

QElectroTech can represent processes using IEC 61131-3 standards (Ex.: GRAFCET, Ladder, etc.).

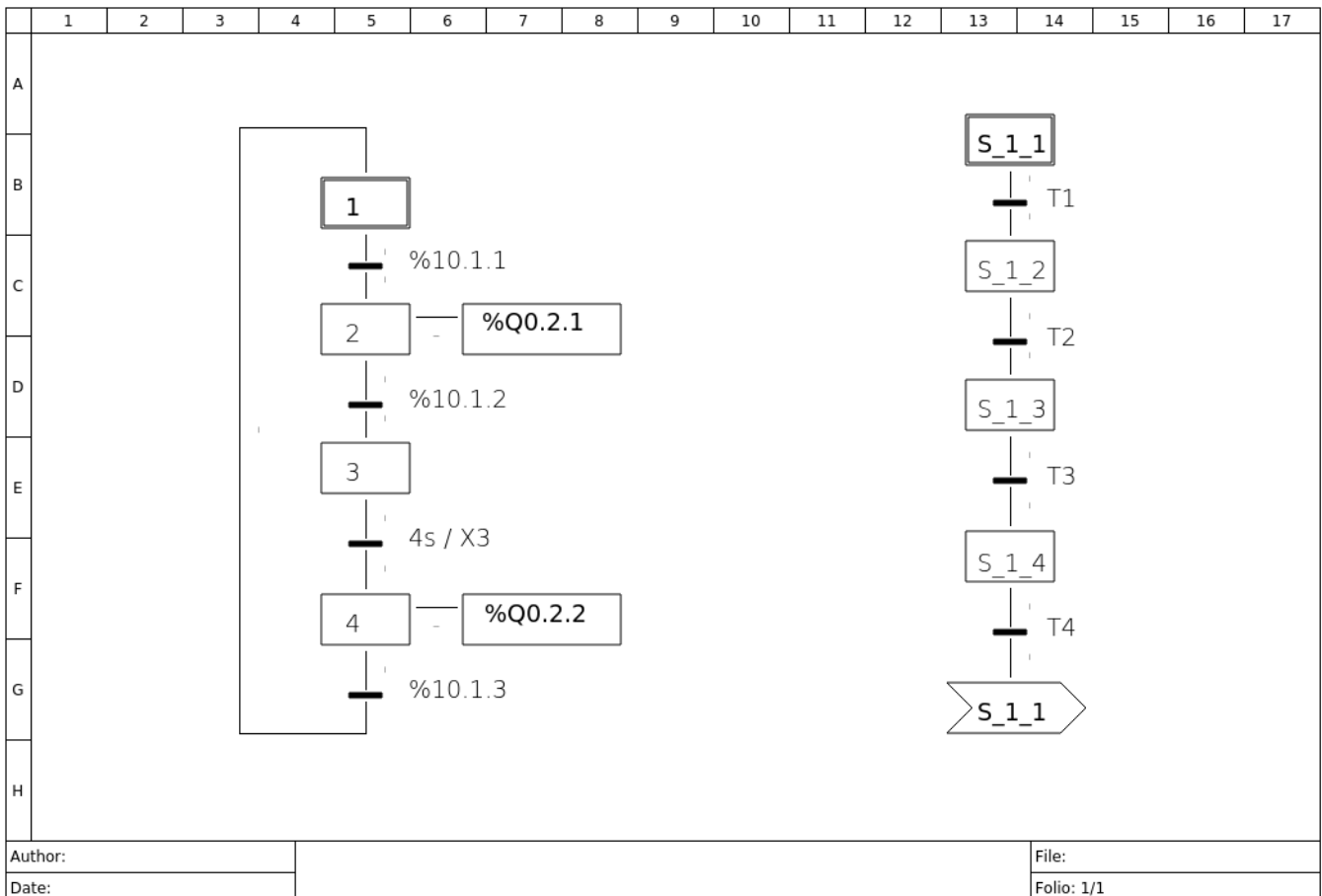

Figure: Single line diagram

## Add new Folio

QElectroTech allows creating folios from [menu bar](#), [projects panel](#), [folios tabs bar](#) and using the corresponding keyboard shortcut.

### Add new folio from menu bar

1. Select **Project > Add a folio** menu item to add a new folio to the active [project](#).

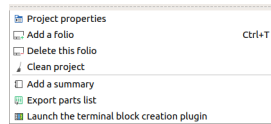

Figure: QElectroTech Project menu

### Add new folio from projects panel

1. Right click on the [project](#) where a new folio should be added.
2. Click the option **Add a folio** to add a new folio to the [project](#).

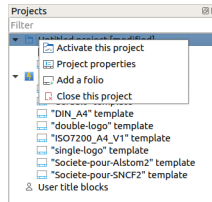

Figure: QElectroTech Project panel

## Note

If the [projects panel](#) is not displayed, it can be displayed from **Settings > Display > Projects**

### Add new folio from folios tabs bar

1. Click on the **Add folio** icon  from right side of the [folios tabs bar](#) to add a new folio to the active [project](#).

### Add new folio using keyboard shortcut

QElectroTech allows using keyboard shortcut to increase the working efficiency.

1. Press **Ctrl + t** to add a new folio to the active [project](#).

## Seealso

For more information about QElectroTech keyboard shortcuts, refer to [menu bar](#) section.

## Delete Folio

QElectroTech allows deleting [folios](#) from a [project](#) from [menu bar](#) and [projects panel](#).

## Delete folio from menu bar

1. Select **Project > Delete this folio** menu item to delete the active folio.

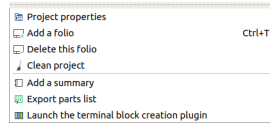

Figure: QElectroTech Project menu

## Delete folio from projects panel

1. Right click on the folio which should be deleted.
2. Click the option **Delete this folio** to delete the selected folio.

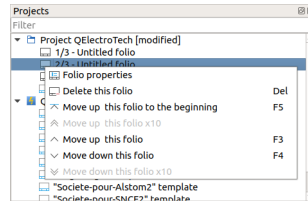

Figure: QElectroTech Project panel

### Note

If the [projects panel](#) is not displayed, it can be displayed from **Settings > Display > Projects**

## Folio properties

### Display folio properties

The [folio properties](#) can be common at all [folios](#) from the same [project](#). QElectroTech also allows that each [folio](#) has its own properties. For example, two [folios](#) can be created by different authors or they can have different revision item.

### Note

To reduce the creation time, QElectroTech allows creating some pre-setting for all future [folios](#) that will be created at the [project](#). For more information about how to pre-define [folio properties](#), refer to [project properties](#) section.

The folio properties window can be displayed from [menu bar](#), [workspace](#), [toolbar](#), [projects panel](#), [folios tabs bar](#) and using the corresponding keyboard shortcut.

### Display folio properties from menu bar

1. Select **Edit > Folio properties** menu item to display [folio properties](#) from the active [folio](#).

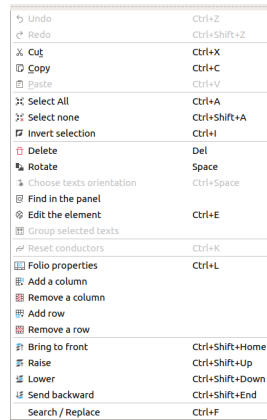

Figure: QElectroTech Edit menu

### Display folio properties from workspace

1. Right click on the **workspace** area. Should be somewhere without any **element**, **conductor**, **table**, etc.
2. Click the option **Folio properties** to display **folio properties** from the active **folio**.

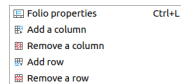

Figure: QElectroTech Workspace Menu

### Display folio properties from toolbar

1. Select the icon  from **toolbar** to display **folio properties** from the active **folio**.

#### Note

If the **toolbar** is not displayed, it can be displayed from **Settings > Display > Diagram**.

### Display folio properties from projects panel

1. Right click on the **folio** where any property should be defined, it can be an inactive **folio** from an inactive **project**.
2. Click the option **Folio properties** to display **folio properties** from the selected **folio**.

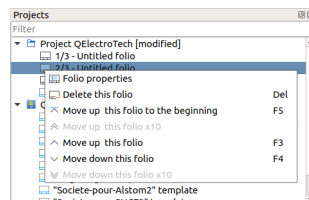

Figure: QElectroTech Project panel

#### Note

If the **projects panel** is not displayed, it can be displayed from **Settings > Display > Projects**

## Display folio properties from folios tabs bar

1. Double click on the **folio tab** to display **folio properties**.



Figure: QElectroTech folio tabs bar

## Display folio properties using keyboard shortcut

QElectroTech allows using keyboard shortcut to increase the working efficiency.

1. Press **Ctrl + 1** to display **folio properties** from the active **folio**.

Seealso

For more information about QElectroTech keyboard shortcuts, refer to [menu bar](#) section.

## Folio size

The working area from the **workspace** is defined as a grid of columns and rows. All columns have the same width and all rows have the same height.

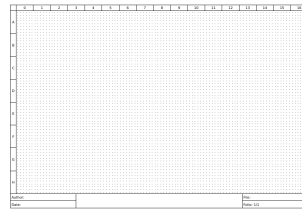

Figure: QElectroTech folio with 17 columns (0 to 16) and 8 rows (A to H) is shown

The parameters that can be customized from **Dimensions of folio** section from the **folio properties PopUp window** are:

1. Number of columns.
2. Width from columns.
3. Column headers display or hidden.
4. Number of rows.
5. Height from rows.
6. Row headers display or hidden.

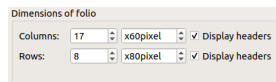

Figure: QElectroTech dimensions of folios section

The version 0.7 from QElectroTech works with pixels and there is no pre-defined folio sizes. The pixels dimensions according **ISO 216** are:

ISO 216	A-	
	mm	pixels
-0	841 x 1189	3178 x 4494
-1	594 x 841	2245 x 3178
-2	420 x 594	1587 x 2245
-3	297 x 420	1122 x 1587



-4	210 x 297	794 x 1122
-5	148 x 210	559 x 794
-6	105 x 148	397 x 559
-7	74 x 105	280 x 397
-8	52 x 74	196 x 280
-9	37 x 52	140 x 196
-10	26 x 37	98 x 140

Seealso

For more information about how to display folio properties, refer to [display folio properties](#) section.

### ***Title block properties section***

The title block section from the [folio properties](#) is the section used to define the [title block](#) template used at the [folio](#). The folio variables can also be managed from this section.





#### **Note**

To reduce the creation time, QElectroTech allows creating some pre-setting for all future folios that will be created in the project. The folio variable values and the [folio title block](#) can be predefined at the project properties. For more information about how to pre-define folio properties, refer to [project properties](#) section.

The title block section is organized on three different areas: title block selection area, main variable tab and costum variable tab.

### ***Title block selection area***

The title block selection area is used to define the [folio title block](#). The actions that can be managed from this section are:

1. Select the [folio title block](#) from the [project title block collection](#).
2. Select the position of the title block in the folio, bottom  or right  side.
3. Edit the [title block](#) pressing the button  and choosing the option **Edit this template**.
4. Duplicate the [title block](#) in the [project title block collection](#) pressing the button  and choosing the option **Duplicate and edit this template**.

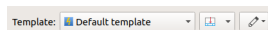

*Figure: Folio title block selection area*

Seealso

For more information about QElectroTech title block, refer to [title block](#) section.

### ***Main folio properties tab***

The **Main** tab provides the default folio variables.

Figure: Folio title block main tab

The default folio variables are:

- **Title:** Title from the folio.
- **Author:** Author from the folio.
- **Date:** Date of creation of the folio.
- **File:**
- **Folio:** Folio information (Label).
- **Plant:** Folio variable named Plant.
- **Location:** Folio variable named Location.
- **Rev index:** Revision index from the folio.
- **Page Num:** Auto numbering pattern from the folio.

Seealso

For more information about default variables, refer to [variables](#) section.

### Costum properties folio tab

The **Costum** tab is the section where custom variables can be defined.

Name	Value

Figure: Folio title block custom tab

To define a user folio variable:

1. Define variable name at the **Name** column from the variables table.
2. Define variable value at the **Value** column from the variables table.

### Folio conductor type

The **Type** tab from folio properties PopUP window allows pre-defining the [type of conductor](#) that will be drawn in the folio later. The [conductor properties](#) can also be pre-defined. This action avoid defining individually the conductor type and the common properties for each conductor created in the folio.

Seealso

For more information about conductor properties, refer to [conductor type](#) section.

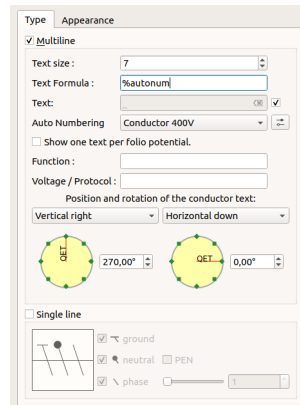

Figure: QElectroTech folio type properties tab

Seealso

For more information about how to display folio properties, refer to [display folio properties](#) section.

### **Folio conductor appearance**

The **Appearance** tab from folio properties PopUP window allows pre-defining the [conductor appearance](#) of the conductors that will be drawn in the folio later. If all conductors from the folio should have the same appearance, this action avoid defining individually the [conductor appearance](#).

Seealso

For more information about conductor properties, refer to [conductor appearance](#) section.

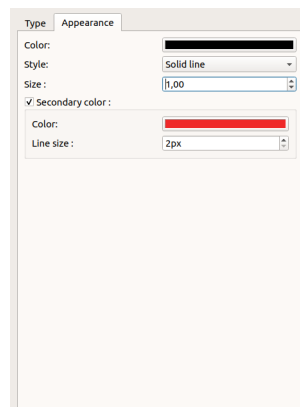

Figure: Folio appearance properties

Seealso

For more information about how to display folio properties, refer to [display folio properties](#) section.

### **Title Block**

## What is the title block?

The title block of a drawing is a table which usually is placed at the bottom from the drawing. The title block is the responsible to provide all necessary information to identify and verify the drawing validity.

Author:		File:
Date:		Folio: 1/1

Figure: QElectroTech Title block example

Some information which can be found at a title block is:

- Drawing / Schema title
- Drawing / Schema number
- Drawing / Schema size (Horizontal A3 sheet is the more common at electrical shemas)
- Revision index
- Author
- Date
- License (Ex.: [ISO 16016](#) protection notices for restricting the use of documents and products)
- Logo

## Note

Refer to [IEC 61082-1](#) norm for more detailed information about the recommended content that should be included in the title block.

As table, the elemets from a title block are:

1. Cell
2. Column
3. Row

## Title block properties

### Title block parent collection

The parent collection property from a [title block](#) defines the [title block collection](#) to which the [title block](#) belongs.

This property defines the rights from the user to [edit the title block](#). A [title block](#) with [QET title block collection](#) as parent collection can only be read by the user. A [title block](#) with [user title block collection](#) or [project title block collection](#) as parent collection can be read and written ([edited](#)) by the user.

The parent collection from a [title block](#) can be defined during the [save process](#).

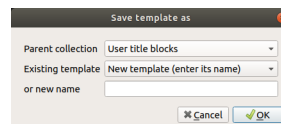

Figure: QElectroTech title block save PopUP window

### Title block extra information

QElectroTech provides the option to define a string field property named **Extra information**. This property field is provided to allow the user defining the author and/or license from [title block](#). Any other information can also be defined in this property field.

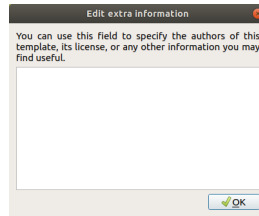

Figure: QElectroTech title block extra information PopUP window

To display/edit the extra information from the [title block](#):

1. Display [title block](#) in the [title block editor](#).
2. Go to **Edit > Edite extra information** menu item to display extra information PopUP window.

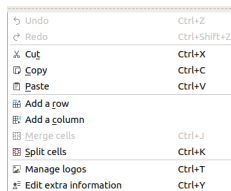

Figure: QElectroTech title block edit menu

#### Seealso

For more information about customizing title block extra information, refer to [define title block extra information](#) section.

## Title Block collections

### What is a collection?

A title block collection is a database where all title block files are stored and classified.

QElectroTech has two different title block collections integrated, [QET collection](#) and [User collection](#). The title block collections can be found at [projects panel](#).

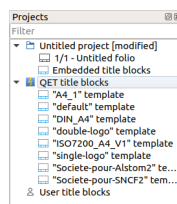

Figure: QElectroTech projects panel

QElectroTech displays also a third collection when a [project](#) is opened, the [project collection](#). This collection is not part from the software structure and it is managed automatically by QElectroTech during the folio title block definition.

### Title block QET collection

The **QET** collection is the default collection from QElectroTech. This collection is protected and the user can only read it, the **QET** collection cannot be edited. The user cannot add or delete any [title block](#) in the database.

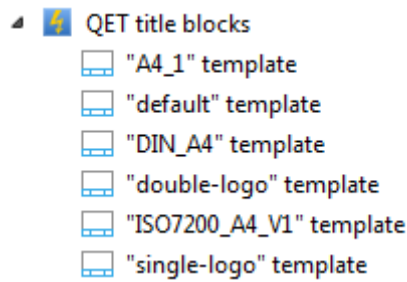

Figure: QET collection tree at project panel

### Title block User collection

The **User** collection is the QElectroTech collection where the user can create [title block](#), the user is allowed to read and edit the collection. The allowed actions at the **User** collection are:

1. Add new [title block](#).
2. Edit [title block](#) from collection.
3. Delete [title block](#) from collection.

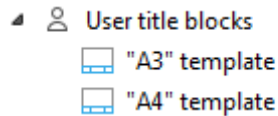

Figure: Example user collection tree at project panel

### Title block project collection

The project collection is the only [collection](#) which is not part from the software structure. A project collection is a [title block collection](#) that is part of the project file, each [project](#) has its own [title block collection](#).

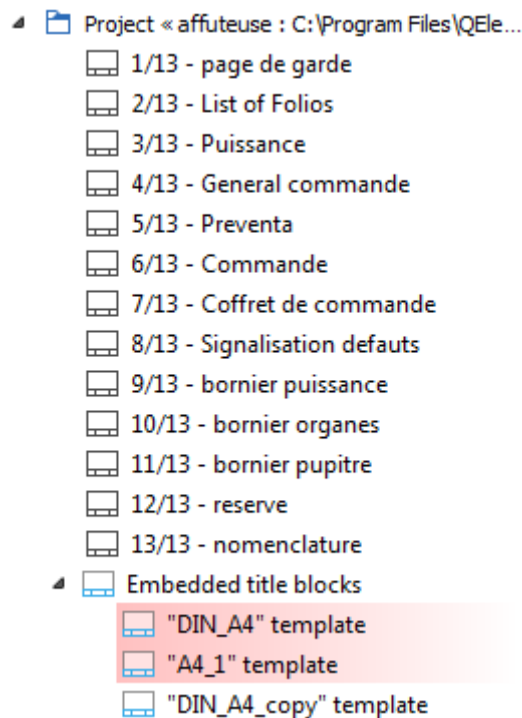

Figure: QElectroTech project tree

QElectroTech does not allow working on this [collection](#), the user cannot add or delete any [title block](#) manually. The user can only edit [title blocks](#) used in the project without modifying the original [title block](#) from [QET](#) or [User](#) collection.

The **title block** is copied from **QET** or **User** collection automatically by **QElectroTech** when the user introduces a new **title block** in one **folio** of the **project**. If the **title block** has already been used previously, **QElectroTech** does not need to add again the **title block** to the project collection.

If one **title block** is deleted from the **project**, **QElectroTech** does not delete the **title block** from the project collection automatically, the **title block** is marked in red. **Cleaning the project** deletes all **title block** from the project collection that are not used inside the **project** automatically at the cleaning time.

## Title block elements

### Cell

#### Definition

A cell from the **title block** is the most basic storage unit available. The three different type of cells are: empty cell, text cell and logo cell.

#### Empty cell

An empty cell is used when the area occupied by the cell should be empty and without any edge displayed. This type of cell has no properties.

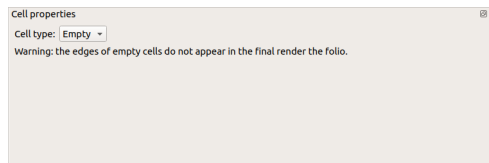

Figure: QElectroTech title block empty cell properties

#### Text cell

A text cell is used when the area occupied by the cell should be filled by string information inside a rectangle. This type of cell has different parameters that can be defined.

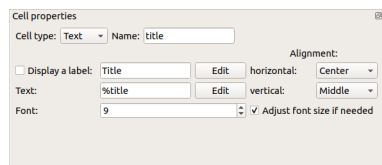

Figure: QElectroTech title block text cell properties

**Name:** Name from cell

**Label:** When the cell should display a variable from the folio or project properties, the label is the text that appears before the variable.

**Text:** It can be a simple string defined by the user or a variable from the folio or project (Ex: Author, Revision, Date, project name, folio page, etc.).

**Font:** Font from the label and text of the cell.

**Alignment:** Vertical and horizontal position of the label and text from the cell inside the cell.

#### Logo cell

A logo cell is used when the area occupied by the cell should be filled by a picture inside a rectangle. This type of cell has different parameters that can be defined.

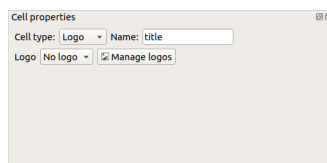

*Figure: QElectroTech title block logo cell properties*

**Name:** Name from cell

**Logo:** Name of the Scalable Vector Graphic (SVG) file with the logo image.

## Note

Many different tools allows you to create Scalable Vector Graphics, SVG files. Inside the Open Source world, [Inkscape](#) is on of the recomended tools.

## Row

### Definition

A row of [cells](#) from the [title block](#) is a group of [cells](#) that are placed one beside the other.

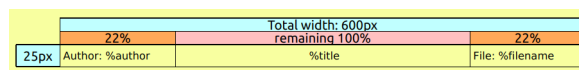

*Figure: QElectroTech title block row*

### Properties

A row from the [title block](#) has only one property, the height of the [cells](#) that are part of the row.

To display the row height:

1. Double click on the row head.

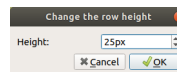

*Figure: QElectroTech title block row height property*

## Note

QElectroTech works with pixels, the height of the row can only be defined according pixel unit.

## Column

### Definition

A column of [cells](#) from the [title block](#) is a group of [cells](#) that are placed one over the other.

### Properties

At QElectroTech, a column from the [title block](#) has only one property, the width of the [cells](#) that are part of the columns.

To display the column width:

1. Double click on the column head.



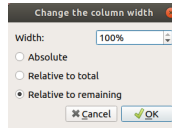

Figure: QElectroTech title block column width property

QElectroTech works with pixels, the width is defined according pixel unit.

Unlike rows, the width of a column can be defined as:

- Absolut value, pixel units.
- Relative value to total, percent of the total width of the [title block](#).
- Relative value to remaining, percent of the remaining width of the [title block](#).

### Create new title block

Creating new title block from cero is not allowed, one template can only be created starting from an other. If no template is choosed, the default title block from [QET collection](#) is the base to create a new title block.

Author:		File:
Date:		Folio: 1/1

Figure: QElectroTech default title block

### Create title block from menu bar

1. Select **Project > Project properties > New folio** menu item to display [default folio properties](#) from [project](#).
2. Go to [title block informations](#) and select the base title block that should be used to create the new one.
3. Select the option **Duplicate and edit this template**.

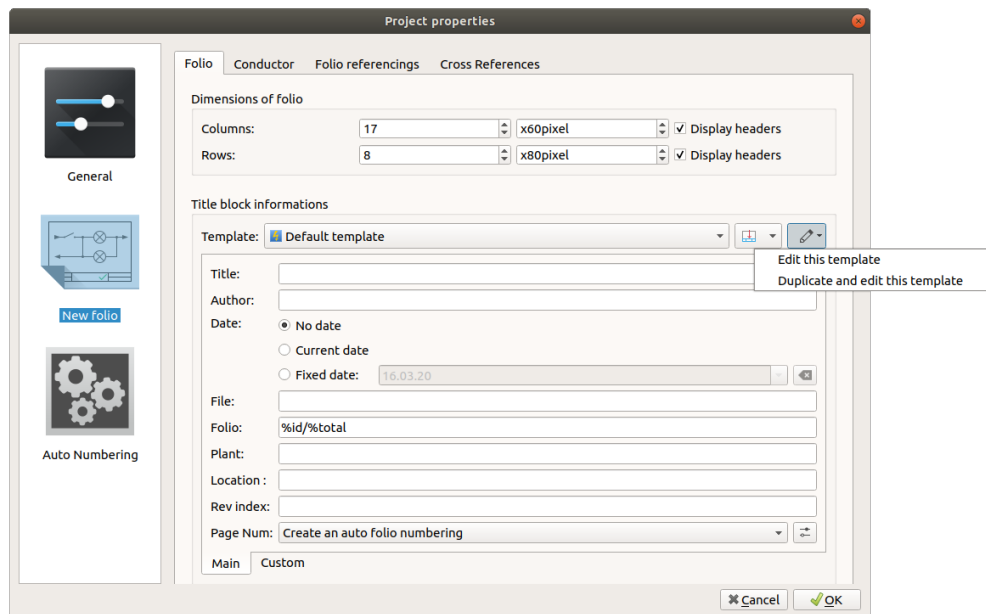

Figure: QElectroTech New folio properties PopUP window

4. Choose the name for the new title block template and press **OK** to create it.



Figure: QElectroTech New folio save PopUP window

### Create title block from folio properties

1. Display folio properties from one of the folios of the project.
2. Go to title block informations and select the base title block that should be used to create the new one.
3. Select the option **Duplicate and edit this template**.

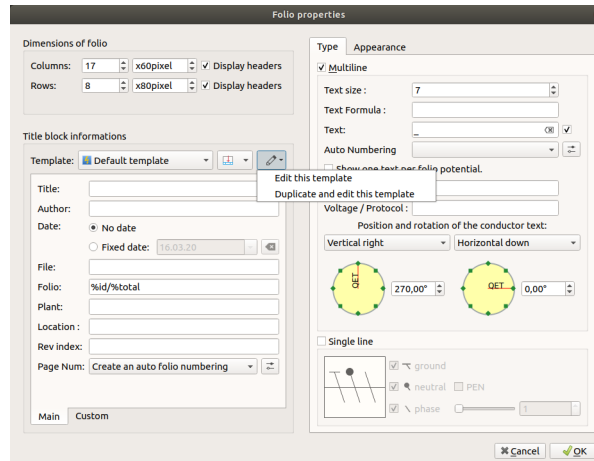

Figure: QElectroTech New folio properties PopUP window

4. Edit the template and save it.
5. Choose the parent collection and the name from the new title block template, then press **OK** to create it.

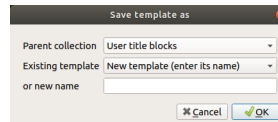

Figure: QElectroTech New folio save PopUP window

### Create title block from project panel

1. Right click on the **user title blocks** collection from project panel.
2. Click the option **New template** to add a new title block with the default template from **QET** collection as base.

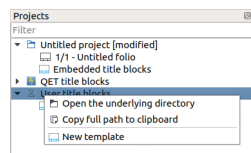

Figure: QElectroTech Project panel

### Note

If the **project panel** is not displayed, it can be displayed from **Settings > Display > Projects**.

### Edit title block

QElectroTech only allows editing the templates from [User collection](#) or [project embedded collection](#). The [QET collection](#) title blocks cannot be edited.

## Note

QElectroTech allows opening the title block templates from [QET collection](#) with [title block editor](#). Once the template is modified, it has to be saved using the option **Save as** and create a new template.

### Edit title block from menu bar

1. Select **Project > Project properties > New folio** menu item to display [default folio properties](#) from [project](#).
2. Go to [title block informations](#) and select the title block which should be edited.
3. Select the option **Edit this template** to display [title block editor](#).

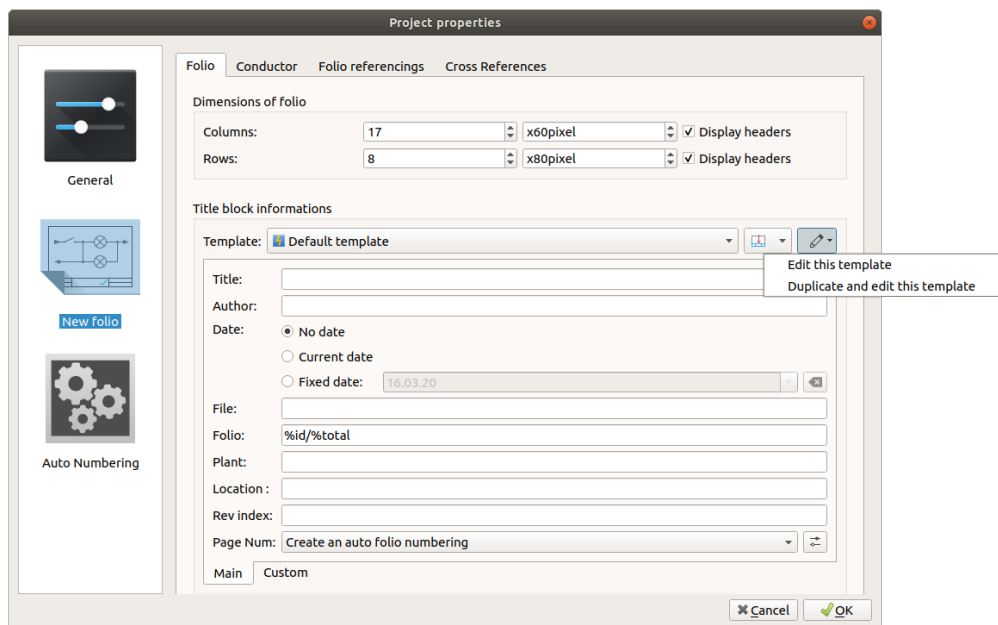

Figure: QElectroTech new folio properties PopUP window

### Edit title block from folio properties

1. Display [folio properties](#) from one of the [folios](#) of the [project](#).
2. Go to [title block informations](#) and select the title block which should be edited.
3. Select the option **Edit this template** to display [title block editor](#).

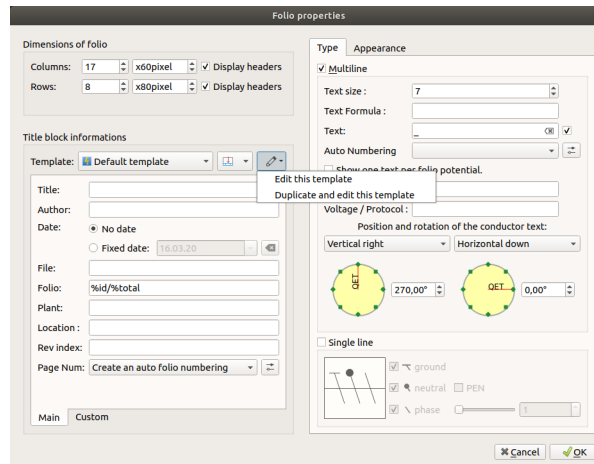

Figure: QElectroTech folio properties PopUP window

### Edit title block from project panel

1. Right click on one title block template which should be edited.
2. Click the option **Edit this template** to open the template with [title block editor](#).

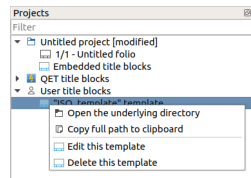

Figure: QElectroTech Project panel

### Note

If the [project panel](#) is not displayed, it can be displayed from **Settings > Display > Projects**.

### Delete title block

The title blocks templates can only be deleted from [project panel](#). QElectroTech does not allow deleting templates from any menu item.

### Note

If the [project panel](#) is not displayed, it can be displayed from **Settings > Display > Projects**.

It is important to make difference between the [project embedded collection](#) and [QET](#) or [User](#) collection. The [project embedded collection](#) is in the project “database”, delete information from the project does not change anything at QElectroTech or in the computer file system. Deleting information from [QET](#) or [User](#) collection deletes information from QElectroTech “database” and in the computer file system, the information deleted in these “databases” can never be recovered.

### Delete title block from project

1. Right click on one title block template from [project embedded collection](#) which should be deleted.
2. Click the option **Delete this template** to delete the template form project “database”.

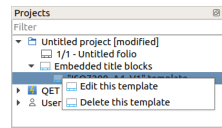

Figure: QElectroTech Project panel

### Delete title block from collection

1. Right click on the title block template from **QET** or **User** collections which should be deleted.
2. Click the option **Delete this template** to delete the template from QElectroTech and from the file system.

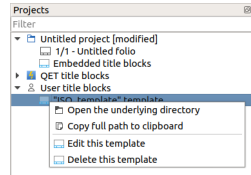

Figure: QElectroTech Project panel

3. Press **YES** to confirm the action.

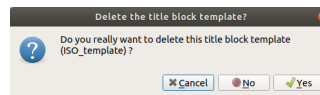

Figure: QElectroTech delete title block confirmation PopUP window

### Warning

The template deleted from one collection cannot be recovered, it will be deleted from QElectroTech “database” and from the computer file system. Be sure about the operation.

### Title block editor

#### Interface title block editor

#### Elements title block window

The title block editor window is a PopUP window from QElectroTech. It has also been designed using **Qt** framework and widget toolkit. The window from QElectroTech title block editor is the same for all platforms where it is available (Windows, Linux/Unix and MacOS). The window from the title block editor contains the following areas:

1. Menu bar
2. Toolbar
3. Drawing area
4. Panels

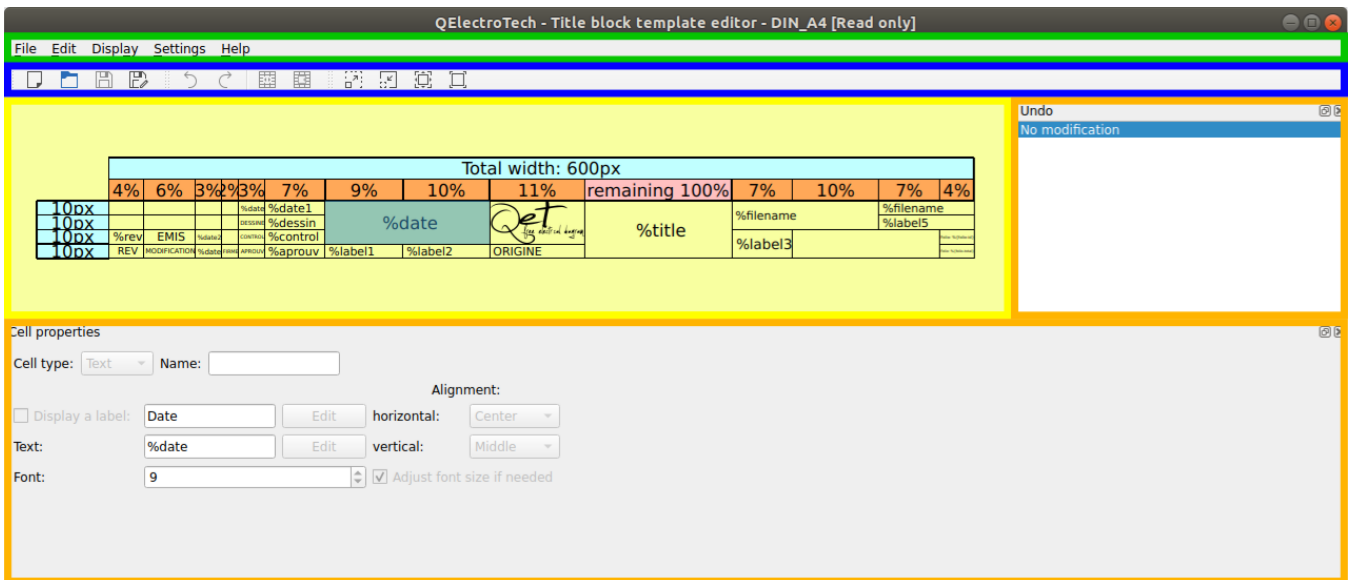

Figure: QElectroTech Title block editor window

**Title block editor menu bar**

The menu bar is placed at top from title block editor window. The title block editor contains the menus File, Edit, Display, Settings, and Help. Each menu provides many different options.

**File menu**

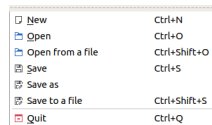

Figure: QElectroTech file menu

Option	Function	Keyboard shortcut	Icon
New	Creates a new Title Block	Ctrl + n	
Open	Opens an existing Title Block from collection	Ctrl + o	
Open from a file	Opens an existing Title Block from file	Ctrl + o	
Save	Saves the current Title Block changes (overwrites)	Ctrl + s	
Save as	Saves the Title Block as a new Title Block from a library		
Save to a file	Saves the Title Block as a different file in disk	Ctrl + Shift + t + x	
Quit	Quits QElectroTech Title Block editor	Ctrl + q	

**Edit menu**

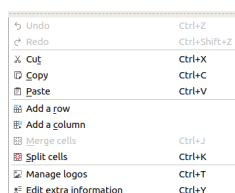

Figure: QElectroTech edit menu

Option	Function	Keyboard shortcut	Icon
Undo	Undoes the previous action	Ctrl + z	
Redo	Restores the undone action	Ctrl + shift + z	
Cut	Puts selected elements / cells into the clipboard	Ctrl + x	
Copy	Copies selected elements / cells	Ctrl + c	
Paste	Pastes elements from the clipboard into cell	Ctrl + v	
Add a row	Adds a row at bottom from title block		
Add a column	Adds column at right side from title block		
Merge cells	Merges selected cells	Ctrl + j	
Split cells	Splits selected cells	Ctrl + k	
Manage logos	Manages pictures to embed logos in the title block	Ctrl + t	
Edit extra information	Displays field to specify additional information	Ctrl + y	

### Display menu

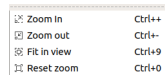

Figure: QElectroTech display menu

Option	Function	Keyboard shortcut	Icon
Zoom In	Expands the workspace	Ctrl + +	
Zoom Out	Shrinks the workspace	Ctrl + -	
Fit in view	Adjusts the zoom on exactly the part of the workspace	Ctrl + 9	
Reset zoom	Restores default zoom level	Ctrl + 0	

### Settings menu

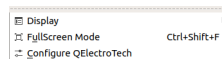

Figure: QElectroTech settings menu

Option	Function	Keyboard shortcut	Icon
Display	Displays or hides toolbars and panels		
Full screen mode	Displays QElectroTech in full screen mode	Ctrl + Shift + f	
Configure QElectroTech	Allows specifying various parameters for QElectroTech		

### Help menu



Figure: QElectroTech help menu

Option	Function	Keyboard shortcut	Icon
What's This?	Enquires main menu options	Shift + f1	
About QElectroTech	Displays information about QElectroTech		
Online manual	Lauches the default browser to the online manual of QElectroTech	f1	
Youtube channel	Lauches the default browser on the Youtube channel of QElectroTech		
Support the project with a donation	Lauches the default browser on the QElectroTech donation paypal account		
About Qt	Displays information about Qt library		

### Toolbars

In addition to the different menus, QElectroTech provides also toolbars. The toolbars are groups of buttons with icons which initiate an accion. In general, these buttons have its counterpart at one of the menus from the [menu bar](#).

The different toolbars can be hidden or placed in one or more rows below the [menu bar](#). The toolbars can also be placed on column at the left or right side from the main window.

### Note

To help the user, a tooltip is displayed when the arrow is placed on each button.

### Toolbar Tools



Figure: QElectroTech title block toolbar Tools

The different buttons from toolbar **Tools** are:

Option	Function	Keyboard shortcut	Icon
New	Creates a new Title Block	Ctrl + n	
Open	Opens an existing Title Block from collection	Ctrl + o	
Save	Saves the current Title Block changes (overwrites)	Ctrl + s	
Save as	Saves the Title Block as a new Title Block from a library		

### Note

Select **Settings > display > Tools** menu item to display or hidden the toolbar Tools.

### Toolbar Edit





Figure: QElectroTech title block toolbar Element

The different buttons from toolbar **Edit** are:

Option	Function	Keyboard shortcut	Icon
Undo	Undoes the previous action	Ctrl + z	
Redo	Restores the undone action	Ctrl + shift + z	
Merge cells	Merges selected cells	Ctrl + j	
Split cells	Splits selected cells	Ctrl + k	

**Note**

Select **Settings > display > Edit** menu item to display or hidden the toolbar Edit.

**Toolbar Display**



Figure: QElectroTech title block toolbar Display

The different buttons from toolbar **Display** are:

Tool	Function	Keyboard shortcut	Icon
Zoom in	Zoom in at drawing area	Ctrl + +	
Zoom out	Zoom out at drawing area	Ctrl + -	
Fit in view	Adjusts the zoom on exactly the part of the workspace	Ctrl + 9	
Reset zoom	Restores default zoom level	Ctrl + 0	

**Note**

Select **Settings > display > Display** menu item to display or hidden the toolbar Display.

**Drawing area**

The drawing area or grafical editor, is the area where the title block **columns**, **rows** and **cells** are managed. How looks the drawing area from **title block editor** is shown below.

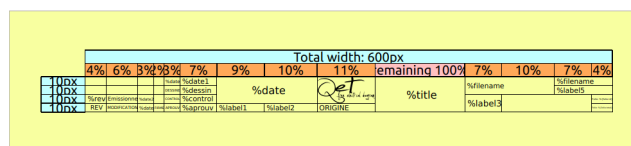

Figure: QElectroTech title block grafical editor

**Title block editor panels**

## Cell properties panel

The Cell properties panel displays the properties from the selected [cell](#).

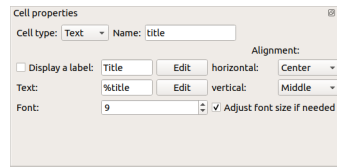

Figure: QElectroTech Cell properties panel

To display the Cell properties panel:

1. Select **Settings > display > Cell properties** menu item to display Cell properties panel.

## Undo panel

The Undo panel displays the history since last time that the [title block](#) was saved. Once the [title block](#) is saved, undo panel is automatically cleaned.

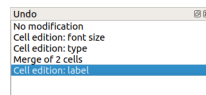

Figure: QElectroTech Undo panel

To display Undo panel:

1. Select **Settings > display > Undo** menu item to display Undo panel.

Seealso

For more information about utilities from Undo panel, refer to [QElectroTech Undo panel](#) section.

## Open title block editor

QElectroTech allows displaying the title block editor by one of the following actions:

- [Create new title block](#)
- [Edit title block](#)

## Save title block

The current [title block](#) can be saved from [menu bar](#), [toolbar](#) and using the corresponding keyboard shortcut.

One [title block](#) is conformed by only one file with the format `.titleblock`. The `.titleblock` extension is the native extension from QElectroTech [title blocks](#).

## Save title block from menu bar

1. Select **File > Save** menu item to save the [title block](#) changes.

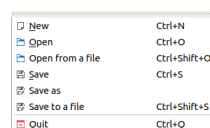

Figure: QElectroTech title block editor File menu

At the case that the opened [title block](#) has to overwrite an existing [title block](#) or it has to be saved as new [title block](#):

1. Select **File > Save as** menu item to display **Save as title block** PopUP window.

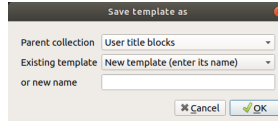

Figure: QElectroTech Save as title block PopUP window

2. Select the **title block** which should be overwritten or the **parent collection** and the name for the new **title block**.
3. Press **OK** button to save the **title block** and close the PopUP window.

The **title block** can also be directly saved as a new file in the Hard Disk directory desired:

1. Select **File > Save to a file** menu item to display the File system PopUp window.
2. Select the directory and the name from the title block file.
3. Press **OK** button to save the **title block** and close the PopUP window.

### Save title block from toolbar

1. Select icon  from **toolbar** to save **title block** changes.

At the case that the opened **title block** has to overwrite an existing **title block** or it has to be saved as new **title block**:

1. Select icon  from **toolbar** to display the **Save as title block** PopUP window.

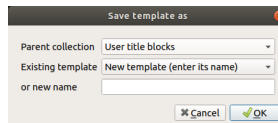

Figure: QElectroTech Save as title block PopUP window

2. Select the **title block** which should be overwritten or the **parent collection** and the name for the new **title block**.
3. Press **OK** button to save the **title block** and close the PopUP window.

### Note

If the **toolbar** is not displayed, it can be displayed from **Settings > Display > Tools**.

### Save title block using keyboard shortcut

QElectroTech allows using keyboard shortcut to increase the working efficiency.

1. Press **Ctrl + s** to save the title block changes.

The **title block** can also be directly saved as a new file in the Hard Disk directory desired:

1. Press **Ctrl + Shift + s** to display the File system PopUp window.
2. Select the directory and the name from the title block file.
3. Press **OK** button to save the **title block** and close the PopUP window.

### Seealso

For more information about QElectroTech keyboard shortcut, refer to **Menu bar** section.

## Quit title block editor

The [title block editor](#) can be closed at any time, only the changes have to be [saved](#) before closing it. QElectroTech displays an automatic message to save the current job if any modification has been created.

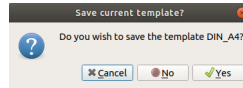

Figure: QElectroTech title block editor save message

## Exit QElectroTech title block editor from menu bar

1. Select **File > Quit** menu item to quit QElectroTech [title block editor](#).

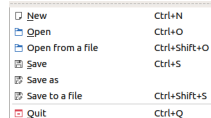

Figure: QElectroTech title block editor File menu

## Exit QElectroTech title block editor using keyboard shortcut

QElectroTech allows using keyboard shortcut to increase the working efficiency.

1. Press `Ctrl + q` to quit QElectroTech [title block editor](#).

Seealso

For more information about QElectroTech keyboard shortcut, refer to [menu bar](#) section.

## Create or edit title block

### Add row to title block

QElectroTech [title block editor](#) allows adding [row](#) from [menu bar](#) and [drawing area](#).

### Add row from menu bar

1. Select **Edit > Add a row** menu item to add a new [row](#) below.

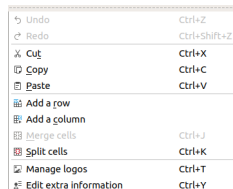

Figure: QElectroTech title block editor, edit menu

## Note

Adding a new [row](#) at top or middle from [title block](#) can only be done from [drawing area](#).

### Add row from drawing area

1. Right click on the head from the **row** below or above the position where the new **row** should be placed.
2. Click the option **Add a row (before)** or **Add a row (after)** to add a new **row** above or below the selected **row**.

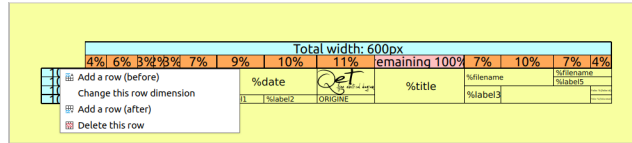

Figure: QElectroTech title block editor, drawing area

### Row height definition

The height from a **row** can only be defined from row head, the left cell which is given the height value from the corresponding **row** . The head from the **row** is not displayed at **folio**, it is only displayed at **title block editor**.

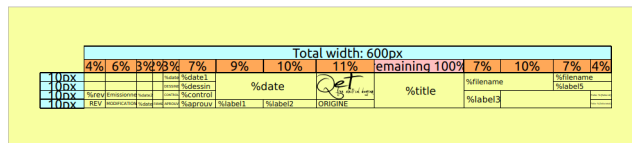

Figure: QElectroTech Title block

1. Double click on row head to display the row height PopUp window.

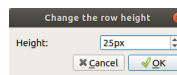

Figure: QElectroTech Title block row height PopUP window

2. Define the height value in pixels.
3. Press **OK**.

### Delete row from title block

QElectroTech **title block editor** only allows deleting **rows** of the **title block** from **drawing area**.

1. Right click on the head from the **row** which should be deleted.
2. Click the option **Delete this row** to delete the selected **row**.

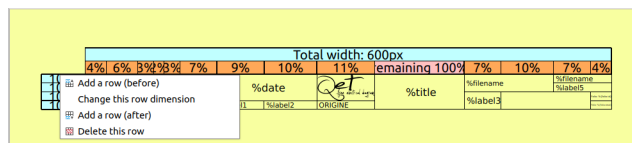

Figure: QElectroTech title block editor, drawing area

### Add column to title block

QElectroTech **title block editor** allows adding **columns** from **menu bar** and **drawing area**.

### Add column from menu bar

1. Select **Edit > Add a column** menu item to add a new **column** at the right side from the **title block**.

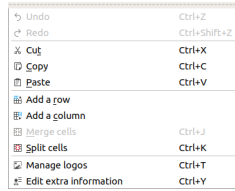

Figure: QElectroTech title block editor, edit menu

## Note

Adding a new column at the middle from the title block can only be done from drawing area.

### Add column from drawing area

1. Right click on the head from the column next to the position where the new column should be placed.
2. Click the option **Add a column (before)** or **Add a column (after)** to add a new column before or after the selected column.

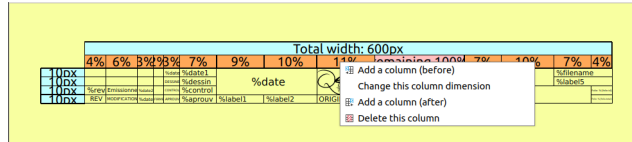

Figure: QElectroTech title block editor, drawing area

### Column width definition

The width from a column can only be defined from the column head, the top cell from the drawing area which gives the width value from the corresponding column. The head from the columns is not displayed in the folio, it is only displayed at title block editor.

1. Double click on column head to display the column width PopUp window.

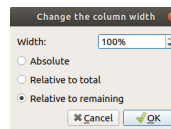

Figure: QElectroTech Title block column width PopUP window

2. Select the click button corresponding to the desired units to define the column width (Absolute, relative to total, relative to remaining).
3. Define the width value.
4. Press **OK**.

## Note

The global width from the title block has to be defined at QElectroTech, for this reason, defining one column width as remanding of 100% is recommended.

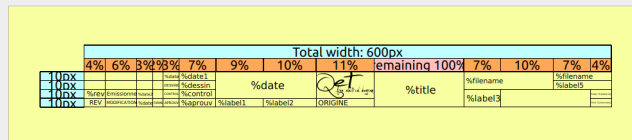

Figure: QElectroTech Title block

At the case that a remanding width is not desired, be sure that the global width from the **title block** matches with the sum of all column widths. At the case that the values are not matching, QElectroTech will display the **title block** as shown below; part of the title block header will be displayed in red and the width difference will be displayed.

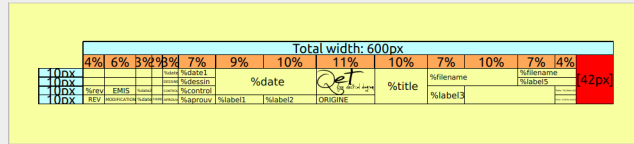

Figure: QElectroTech Title block global width error

## Warning

At the case of using **Relative to remaining**, be sure that the value from the width is 100 %. Otherwise, spare area will appear in the **title block**.

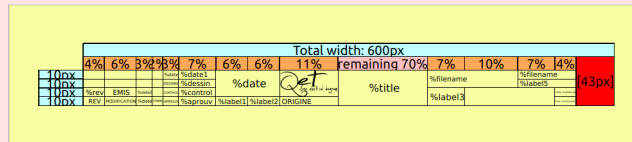

Figure: QElectroTech Title block column width error

## Delete column from title block

QElectroTech **title block editor** only allows deleting **columns** from **drawing area**.

1. Right click on the head from the **column** which should be deleted
2. Click the option **Delete this column** to delete the selected **column**.

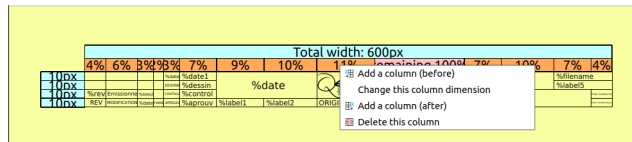

Figure: QElectroTech title block editor, drawing area

## Introduce a logo on the title block

1. Select the **cell** where the logo should be introduced.
2. Go to properties and choose **Logo** at **Cell type** Combo Box.

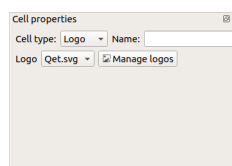

Figure: QElectroTech Title block cell properties

3. Define the name of the **cell**, if it is desired.
4. Press the **Manage logo** button to display the logo manager PopUP window.

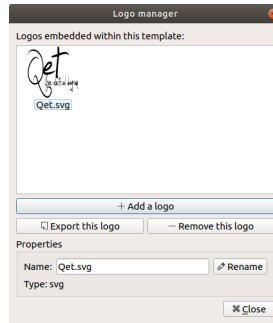

Figure: QElectroTech Title block logo manager PopUP window

5. Press the button **Add a logo** to display the file explorer PopUP window.
6. Choose the SVG or Bitmap file with the desired logo and close the logo manager.
7. Choose the logo added previously at **Logo Combo Box**.

### Define cell content

QElectroTech [title block editor](#) allows defining two different types of content in a [text cell](#) type:

- **Plain text**
- **Variable**

QElectroTech works managing different database, the content of the [cells](#) are stored in the project database. QElectroTech provides the feature of defining the cell content in different languages, the cell content is defined in a cell value table. The content from the different [cells](#) of the [title block](#) are automatically displayed in the language defined.

### Note

The working language from QElectroTech is defined at **Setting > Configure QElectroTech**.

### Add text to cell

1. Select the [cell](#) where the text should be introduced.
2. Press **Edit** button from text field and the cell value PopUP window will be displayed.
3. Press the button **Add a line** to add a new row in the cell value table.
4. Define the 2 letter code that identifies the language from the text at **Language** column.
5. Define the text at **Text** column.
6. Press **OK**

### Note

QElectroTech works according [ISO 639-1](#) norm. The text language is defined using 2 letter code which should be used at the language column from the cell value table.

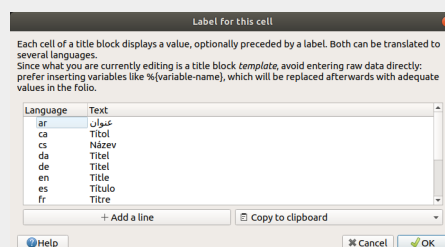



Figure: QElectroTech title block editor, cell label PopUP window

### Add variable to cell

A title block variable is the value of a project or folio property. At QElectroTech, a variable is called using the percent symbol before the variable name (`%{variable-name}`).

### Note

QElectroTech has some default variables that the user does not need to create (ex.: `%{author}`, `%{date}`, `%{title}`, `%{folio}`, `%{projecttitle}`, etc.).

QElectroTech also allows the user defining extra variables:

- Go to **Project > Project properties > General** to define costumized project variables.
- Go to **Edit > Folio properties > Title block informations > Costum** to define costumized folio variables.

QElectroTech allows that the cell has a **Label** for the variable.

To define the label:

1. Select the **cell** where the variable should be introduced.
2. Click the button **Display a label** to introduce a label in the cell. Click on the button and go to variable definition if the **Label** should not be displayed.

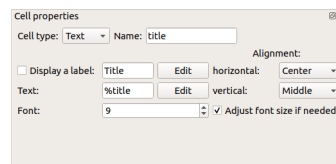

Figure: QElectroTech Title block text cell properties

3. Press **Edit** button from label field and the label value PopUP window will be displayed.

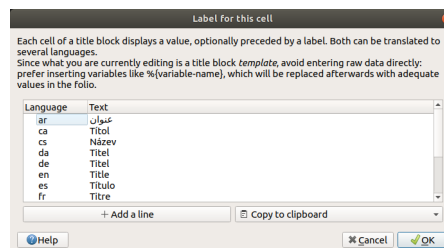

Figure: QElectroTech title block editor, cell value PopUP window

4. Press the button **Add a line** to add a new row in the Label value table.
5. Define the 2 letter code that identifies the language from the text at **Language** column.
6. Define the text at **Text** column.
7. Press **OK**

To define the variable:

8. Press **Edit** button from text field and the cell value PopUP window will be displayed.
9. Press the button **Add a line** to add a new row in the cell value table.

10. Define the 2 letter code that identifies the language from the text at **Language** column. Defining only one language is enough for default variables.
11. Define the variable at **Text** column. A variable is defined as `%{variable-name}`. The default variables can be copied to clipboard at the right bottom Combo Box and pasted (Ctrl + c) in **Text** column cell.

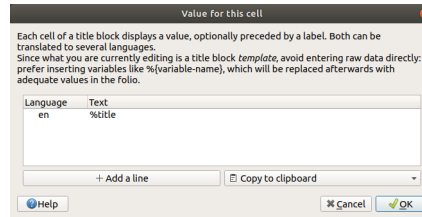

Figure: QElectroTech title block editor, cell value PopUP window

12. Press **OK**

Seealso

For more information about default variables, refer to [default QElectroTech variables](#) section.

### Merge cells

QElectroTech [title block editor](#) allows merging [cells](#) from [menu bar](#), [toolbar](#) and using the corresponding keyboard shortcut.

QElectroTech has no restrictions merging [cells](#), QElectroTech allows merging [cells](#) from same [column](#) and/or [row](#).

### Merge cells from menu bar

1. Select the [cells](#) which should be merged.
2. Select **Edit > Merge cells** menu item to merge the selected [cells](#).

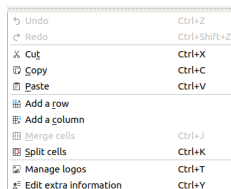



Figure: QElectroTech title block editor, edit menu

### Note

To select more than one [cell](#), press **Ctrl** from keyboard.

### Merge cells from toolbar

1. Select the [cells](#) which should be merged.
2. Select the icon  from [toolbar](#) to merge the selected [cells](#).

### Note

If the [toolbar](#) is not displayed, it can be displayed from **Settings > Display > Edit**

### Merge cells using keyboard shortcut

QElectroTech allows using keyboard shortcut to increase the working efficiency.

1. Select the **cells** which should be merged.
2. Press **Ctrl + j** to merge the selected **cells**.

Seealso

For more information about QElectroTech keyboard shortcut, refer to [menu bar](#) section.

### Split cells

QElectroTech [title block editor](#) allows splitting **cells** previously **merged** from [menu bar](#), [toolbar](#) and using the corresponding keyboard shortcut.

#### Split cells from menu bar

1. Select the merged **cells** which should be splitted.
2. Select **Edit > Split cells** menu item to split the selected **cells**.

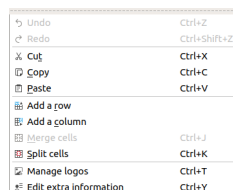



Figure: QElectroTech title block editor, edit menu

#### Split cells from toolbar

1. Select the merged **cells** which should be splitted.
2. Select the icon  from the [toolbar](#) to split the selected **cells**.

### Note

If the [toolbar](#) is not displayed, it can be displayed from **Settings > Display > Edit**

### Split cells using keyboard shortcut

QElectroTech allows using keyboard shortcut to increase the working efficiency.

1. Select the merged **cells** which should be splitted.
2. Press **Ctrl + k** to split the selected **cells**.

Seealso

For more information about QElectroTech keyboard shortcut, refer to [menu bar](#) section.

### Define title block extra information

**Define extra information from menu bar**

1. Select **Edit > Edit extra information** menu item to display **extra information PopUp window**.

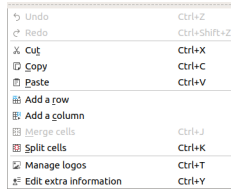

Figure: QElectroTech title block editor Edit Menu

2. Introduce the desired information in the text field.
3. Press **OK** to accept and close **extra information PopUp window**.

**Define extra information using keyboard shortcut**

QElectroTech allows using keyboard shortcut to increase the working efficiency.

1. Press **Ctrl + y** to display the **extra information PopUp window**.
2. Introduce the desired information in the text field.
3. Press **OK** to accept and close **extra information PopUp window**.

Seealso

For more information about QElectroTech keyboard shortcut, refer to **menu bar** section.

**Element**

**What is an element?**

An element is an object wich contains information:

1. Graphical representation information, symbol displayed at the schema.
2. Element data such element position in the poject, article number, manufacturer, supplier, link to any other element from the project, etc.

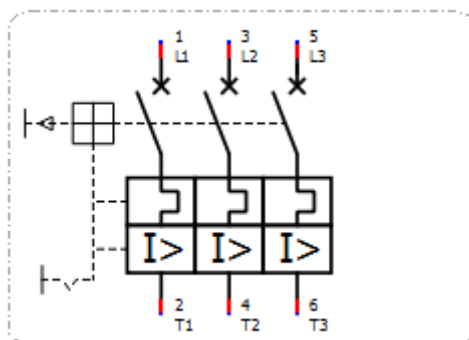

Figure: QElectroTech thermal circuit breaker element

An element is an object which function is to reduce the engineering work. Working with elements reduce the time and work necessary for the creation of schemas, Bill Of Materials (BOM) and many other types of reports such terminal lists, I/O lists, etc.

The element can be classified at different families:

- Simple
- Master
- Slave
- Reference folio following
- Previous reference folio
- Terminal block

The graphical representation information characteristics are the same for all families. The element data properties fields and the possible interlocking options are different between families.

## Type of elements

### Simple element

The simple element is used to represent devices such as actuators (electric motors, cylinders, pneumatic or hydraulic valves, etc.), control devices (PLC, microcontrollers, etc.), circuit breakers, etc.

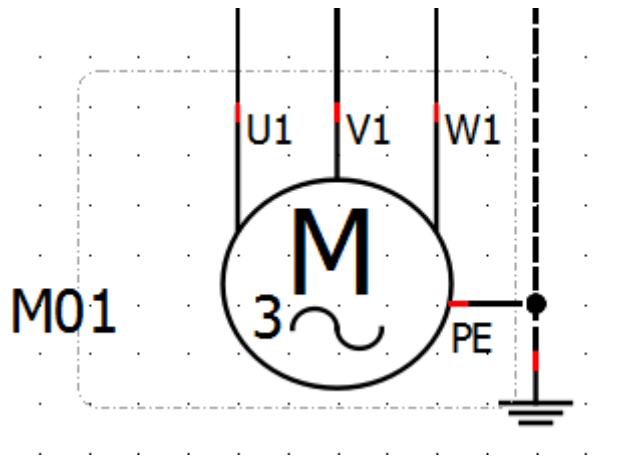

Figure: QElectroTech simple element

For simple element exist two type of variables:

1. General variables common for all type of elements and managed internally by QElectroTech.
2. Specific variables from simple elements.

General variables

- **% {F}**: Label from the folio where the element can be found
- **% {f}**: Number from the folio where the element can be found
- **% {M}**: Plant variable from the folio where the element can be found
- **% {LM}**: Location variable of the folio where the element can be found
- **% {l}**: Folio line number from the workspace where the element can be found
- **% {c}**: Folio column number from the workspace where the element can be found
- **% {id}**: Folio position in the project (Schema number)

Specific variables

- **Label formula**: Definition of the formula which defines the **Label** value. If a auto numbering pattern is selected during terminal creation, QElectroTech defines `%autnum` as default formula.
- **Label**: Internal variable which is used to defines the element code.
- **Annotation**: Internal variable, it cannot be a formula (group of other variables).

- **Textual description:** Internal variable, it cannot be a formula (group of other variables).
- **Article number:** Internal variable, it cannot be a formula (group of other variables).
- **Manufacturer:** Internal variable, it cannot be a formula (group of other variables).
- **Order number:** Internal variable, it cannot be a formula (group of other variables).
- **Supplier:** Internal variable, it cannot be a formula (group of other variables).
- **Auxiliary block 1:** Internal variable, it cannot be a formula (group of other variables).
- **Auxiliary block 2:** Internal variable, it cannot be a formula (group of other variables).
- **Internal number:** Internal variable, it cannot be a formula (group of other variables).
- **Location:** Internal variable, it cannot be a formula (group of other variables).
- **Function:** Internal variable, it cannot be a formula (group of other variables).
- **Voltage/Protocol:** Internal variable, it cannot be a formula (group of other variables).

### Master element

The master elements represent the devices from the command circuit such the coil from a relay or contactor.

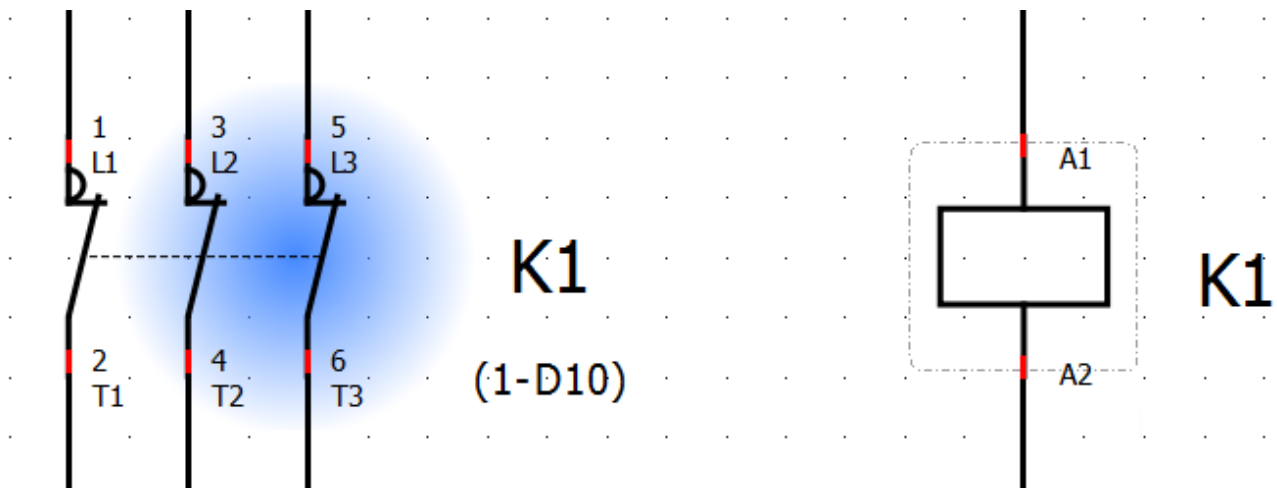

Figure: QElectroTech master element

For master element exist two type of variables, the general variables that are common for all type of elements and managed internally by QElectroTech, and the specific variables for this type of element.

QElectroTech allows defining variable values from master element at the **Selection properties** panel. QElectroTech does not allow defining new variables. QElectroTech allows only displaying variables at dynamic texts and define value of the specific variables.

### Note

If the Selection properties panel is not displayed, it can be displayed from **Settings > Display > Selection properties**.

General variables

- % {F}: Label from the folio where the element can be found
- % {f}: Number from the folio where the element can be found
- % {M}: Plant variable from the folio where the element can be found
- % {LM}: Location variable of the folio where the element can be found
- % {l}: Folio line number from the workspace where the element can be found
- % {c}: Folio column number from the workspace where the element can be found
- % {id}: Folio position in the project (Schema number)

Specific variables

- **Label formula:** Definition of the formula which defines the **Label** value. If a auto numbering pattern is selected during terminal creation, QElectroTech definiens %autnum as default formula.
- **Label:** Internal variable which is used to defines the element code.
- **Annotation:** Internal variable, it cannot be a formula (group of other variables).
- **Textual description:** Internal variable, it cannot be a formula (group of other variables).
- **Article number:** Internal variable which, it cannot be a formula (group of other variables).
- **Manufacturer:** Internal variable, it cannot be a formula (group of other variables).
- **Order number:** Internal variable, it cannot be a formula (group of other variables).
- **Supplier:** Internal variable, it cannot be a formula (group of other variables).
- **Auxiliary block 1:** Internal variable, it cannot be a formula (group of other variables).
- **Auxiliary block 2:** Internal variable, it cannot be a formula (group of other variables).
- **Internal number:** Internal variable, it cannot be a formula (group of other variables).
- **Location:** Internal variable, it cannot be a formula (group of other variables).
- **Function:** Internal variable, it cannot be a formula (group of other variables).
- **Voltage/Protocol:** Internal variable, it cannot be a formula (group of other variables).

**Slave element**

The slave elements represent the power circuit devices such the main contactors from power contactors. The slave elements also represent the auxiliary contactors. Even if an auxiliary contactor is part of the command circuit, its activation is forced by another element.

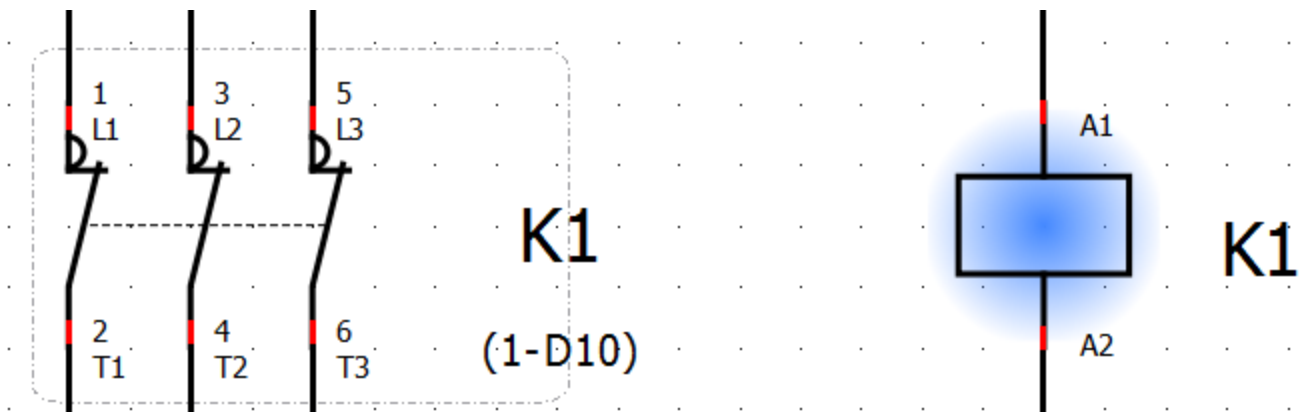

Figure: QElectroTech slave element

For slave element exist two type of variables, the general variables that are common for all type of elements and managed internally by QElectroTech, and the specific variables for this type of element.

QElectroTech does not allow defining variable values for slave element. QElectroTech does also not allows defining new variables. QElectroTech allows only displaying the specific variables at dynamic texts.

## Element

### General variables

- **% {F}**: Label from the folio where the element can be found
- **% {f}**: Number from the folio where the element can be found
- **% {M}**: Plant variable from the folio where the element can be found
- **% {LM}**: Location variable of the folio where the element can be found
- **% {l}**: Folio line number from the workspace where the element can be found
- **% {c}**: Folio column number from the workspace where the element can be found
- **% {id}**: Folio position in the project (Schema number)

### Specific variables

- **Position master element**: Internal pre-defined variable which is automatically displayed under dynamic texts of the element. The default formula from the variable is  $(\%id-\%l\%c)$ , variables took from master element.

### Seealso

The default formula from the **Position master element** and the position where it should be displayed can be defined at cross references tab from **New project** preferences.

### Note

QElectroTech allows also displaying the specific variables from the [Master element](#) at the dynamic text fields.

### Reference folio following

Element which link the end of a [conductor](#) with the beginning of the [conductor](#) represented at previous, following or the same [folio](#).

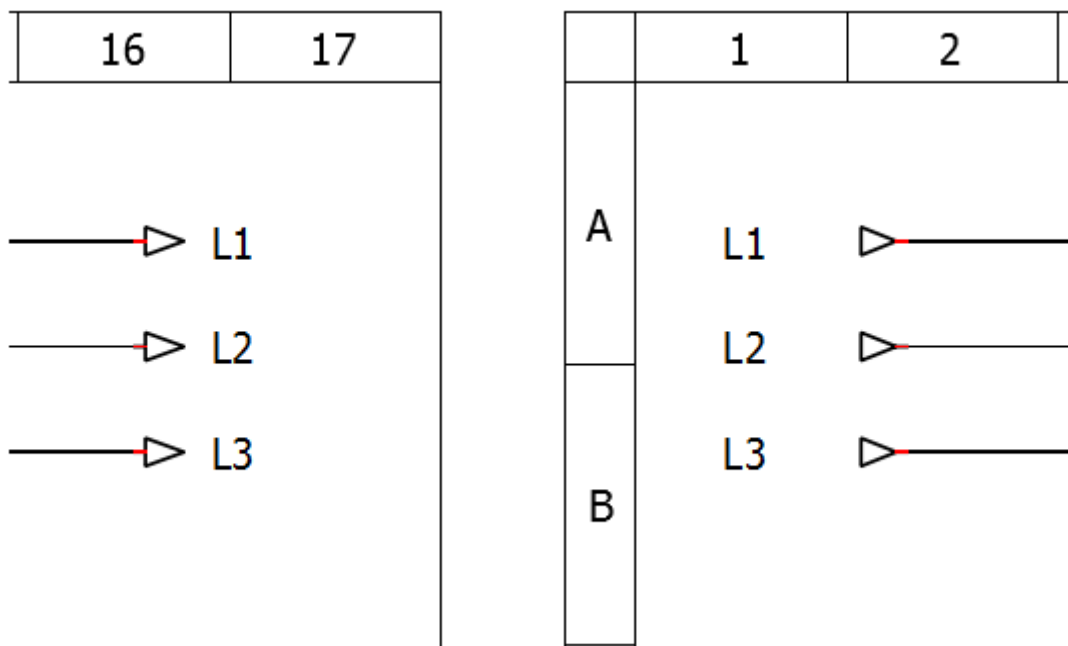

Figure: QElectroTech reference folio following

For reference folio following element exist two type of variables, the general variables that are common for all type of [elements](#) and the specific variables for this type of [element](#).



## Element

QElectroTech does not allow defining variable values for this type of [element](#). QElectroTech does also not allow defining new variables. QElectroTech allows only displaying the specific variables at [dynamic texts](#).

### General variables

- **% {F}**: Label from the [folio](#) where the [element](#) can be found.
- **% {f}**: Number from the [folio](#) where the [element](#) can be found.
- **% {M}**: Plant variable from the [folio](#) where the [element](#) can be found.
- **% {LM}**: Location variable of the [folio](#) where the [element](#) can be found.
- **% {l}**: Folio line number from the [workspace](#) where the [element](#) can be found.
- **% {c}**: Folio column number from the [workspace](#) where the [element](#) can be found.
- **% {id}**: Folio position in the [project](#) (Schema number).

### Specific variables

- **Function**: Function property from the [conductor](#) connected to the [element terminal](#).
- **Label**: Internal variable which defines the position of the linked [previous reference folio](#) element.
- **Voltage/Protocol**: Voltage/Protocol property from the [conductor](#) connected to the [element terminal](#).

### Note

The **Label** property can be defined as a formula by the user at [New folio](#) section from [project properties](#). By default the formula is `%id-%l%c`, variables took from [previous reference folio](#) linked element.

For more information about how to define the **Label** formula, please refers to [folio referencing project properties](#).

### Previous reference folio

Element which link the beginning of a [conductor](#) with the end of the [conductor](#) represented at previous, following or same [folio](#).

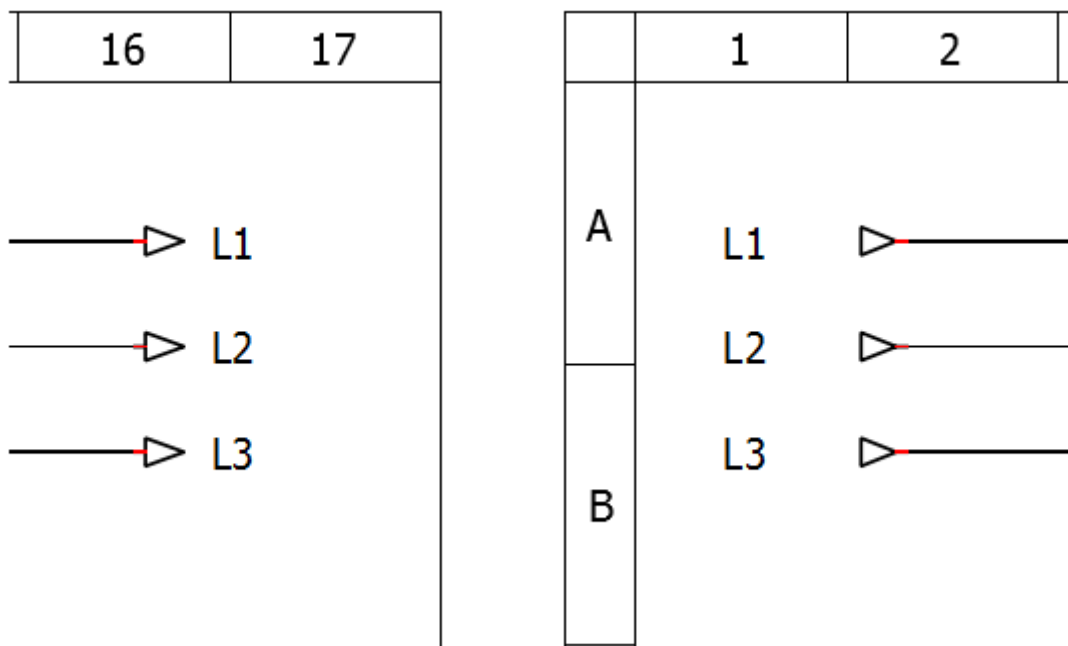

Figure: QElectroTech previous reference folio

For previous referencing folio element exist two type of variables, the general variables that are common for all type of [elements](#) and the specific variables for this type of [element](#).

## Element

QElectroTech does not allow defining variable values for this type of [element](#). QElectroTech does also not allow defining new variables. QElectroTech allows only displaying the specific variables at [dynamic texts](#).

### General variables

- **% {F}**: Label from the [folio](#) where the [element](#) can be found.
- **% {f}**: Number from the [folio](#) where the [element](#) can be found.
- **% {M}**: Plant variable from the [folio](#) where the [element](#) can be found.
- **% {LM}**: Location variable of the [folio](#) where the [element](#) can be found.
- **% {l}**: Folio line number from the [workspace](#) where the [element](#) can be found.
- **% {c}**: Folio column number from the [workspace](#) where the [element](#) can be found.
- **% {id}**: Folio position in the [project](#) (Schema number).

### Specific variables

- **Function**: Function property from the [conductor](#) connected to the [element terminal](#).
- **Label**: Internal variable which defines the position of the linked [reference folio following](#) element.
- **Voltage/Protocol**: Voltage/Protocol property from the [conductor](#) connected to the [element terminal](#).

### Note

The **Label** property can be defined as a formula by the user at [New folio](#) section from [project properties](#). By default the formula is `%id-%l%c`, variables took from [reference folio following](#) linked element.

For more information about how to define the **Label** formula, please refers to [folio referencing project properties](#).

## Terminal block

Element which represents a terminal block, connection between two cables from the same potential.

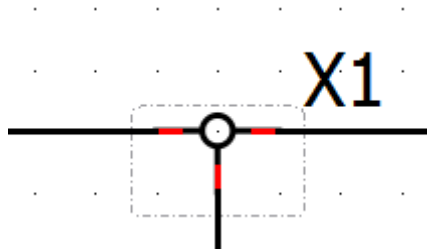

Figure: QElectroTech Terminal block

For terminal block element exist two type of variables, the general variables that are common for all type of elements and managed internally by QElectroTech, and the specific variables for this type of element.

QElectroTech allows defining variable values from this type of element at the **Selection properties** panel. QElectroTech does not allow defining new variables. QElectroTech allows only displaying variables at dynamic texts and define value of the specific variables.

### Note

If the Selection properties panel is not displayed, it can be displayed from **Settings > Display > Selection properties**.

### General variables

- **% {F}**: Label from the folio where the element can be found

- **% {f}**: Number from the folio where the element can be found
- **% {M}**: Plant variable from the folio where the element can be found
- **% {LM}**: Location variable of the folio where the element can be found
- **% {l}**: Folio line number from the workspace where the element can be found
- **% {c}**: Folio column number from the workspace where the element can be found
- **% {id}**: Folio position in the project (Schema number)

#### Specific variables

- **Label formula**: Definition of the formula which defines the **Label** value. If a auto numbering pattern is selected during terminal creation, QElectroTech defiens `%autnum` as default formula.
- **Label**: Internal variable which is used to defines the element code.
- **Annotation**: Internal variable, it cannot be a formula (group of other variables).
- **Textual description**: Internal variable, it cannot be a formula (group of other variables).
- **Article number**: Internal variable, it cannot be a formula (group of other variables).
- **Manufacturer**: Internal variable, it cannot be a formula (group of other variables).
- **Order number**: Internal variable, it cannot be a formula (group of other variables).
- **Supplier**: Internal variable, it cannot be a formula (group of other variables).
- **Auxiliry block 1**: Internal variable, it cannot be a formula (group of other variables).
- **Auxiliry block 2**: Internal variable, it cannot be a formula (group of other variables).
- **Internal number**: Internal variable, it cannot be a formula (group of other variables).
- **Location**: Internal variable, it cannot be a formula (group of other variables).
- **Function**: Internal variable, it cannot be a formula (group of other variables).
- **Voltage/Protocol**: Internal variable, it cannot be a formula (group of other variables).

## *Element properties*

### *Display element properties*

The [element properties](#) can be displayed at the [selection properties panel](#) or in a popUP window. At the case of working without [selection properties panel](#), the properties can be displayed from [menu bar](#), [workspace](#) or using keyboard shortcut.

#### **Note**

At the case of using the [selection properties panel](#), selecting the [element](#) is enough to display automatically the [element properties](#) at the panel.

If the [Selection properties panel](#) is not displayed, it can be displayed from **Settings > Display > Selection properties**.

### *Display element properties from menu bar*

1. Select the [element](#) which [properties](#) should be displayed.
2. Select **Edit > Edit this element** menu item to display the element properties PopUP window.

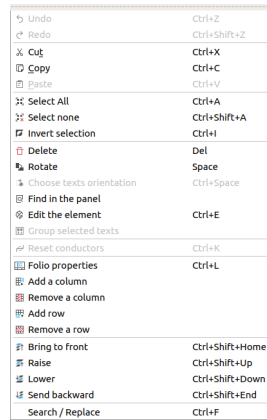

Figure: QElectroTech Edit menu

### Display element properties from workspace

1. Right click on the **element** which **properties** should be displayed.
2. Select **Edit this element** option to display the element properties PopUP window.

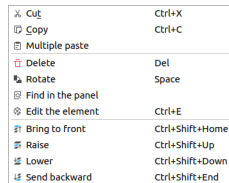

Figure: QElectroTech element options

### Display element properties using keyboard shortcut

QElectroTech allows using keyboard shortcut to increase the working efficiency.

1. Select the **element** which **properties** should be displayed.
2. Press **Ctrl + e** to display the element properties PopUP window.

Seealso

For more information about QElectroTech keyboard shortcut, refer to [menu bar](#) section.

### General properties element

The general properties section from an **element** provides the information:

- **Element name**
- **Element** position in the **project** (**folio**, coordinates, rotation, etc.)
- **Element size**
- Number of **terminals** that the **element** has
- Directory where the element file can be found

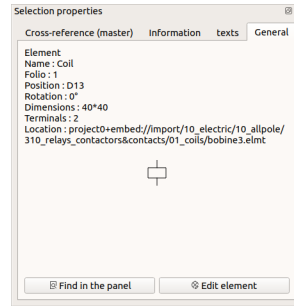

Figure: QElectroTech general element properties

## Texts from element

The element texts section provides all text properties from the [text field](#) and [dynamic text](#) integrated in the [element](#). The text properties available are:

- Text
- Source of the text
- Size
- Font
- Color
- Frame
- Width
- Position
- Rotation
- Alignment

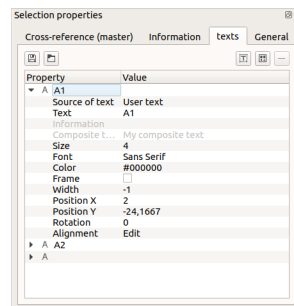

Figure: QElectroTech text element properties

## Element information

The element information section provides all information from the [element](#) which can be exported to the [Bill of Materials \(BOM\)](#). At this section the available information is:

- Element label
- Element location in the system
- Element article number
- Element manufacturer
- Element supplier
- Etc.

**Note**

The element information section is only available for [simple](#), [master](#) or [terminal block elements](#).

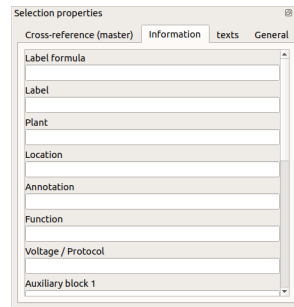

Figure: QElectroTech information element properties

**Element author and license**

QElectroTech provides the option to define the author and the desired license from the [element](#).

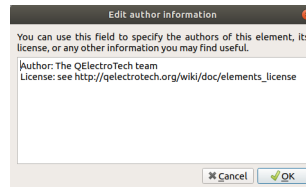

Figure: QElectroTech author and license element PopUP window

The author and the license from an [element](#) cannot be displayed at the [main window](#) from QElectroTech, this information can only be found from [element editor](#).

**Seealso**

For more information about how to find the license and author from an [element](#), refer to [define author element information](#) section.

**Element numbering**

QElectroTech allows an automatic codification of [elements](#). This feature is useful for the creation of reports, [Bill of Materials \(BOM\)](#), and for the identification of devices at the physical installation and schemas.

QElectroTech allows defining multiples auto numbering patterns. It also provides many flexibility on the creation of auto numbering pattern using text, variables and sequential numbers.

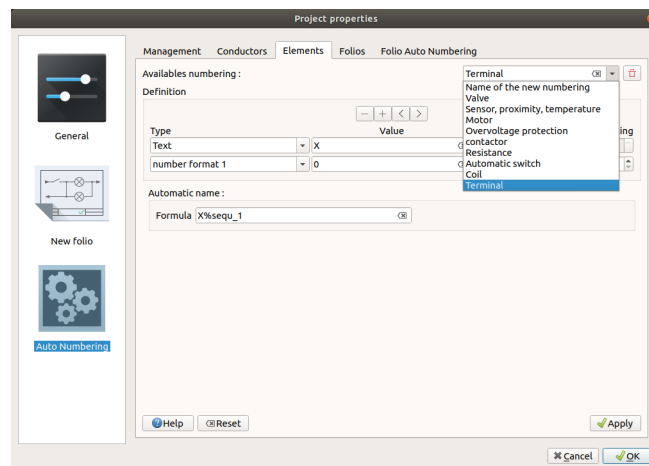

Figure: QElectroTech element auto numbering

## Example

X	AAAA
---	------

**X:** Code defined by [IEC 81346](#) norm.

- **A:** Two or more purposes or tasks.
- **B:** Converting an input variable into a signal for further processing.
- **C:** Storing of energy, information or material.
- **E:** Providing radiant or thermal energy.
- **F:** Direct protection from dangerous or unwanted conditions.
- **G:** Initiating a flow of energy or material.
- **H:** Producing a new kind of material or product.
- **K:** Processing signals or information.
- **M:** Providing mechanical energy for driving purposes.
- **P:** Presenting information.
- **Q:** Controlled switching or varying a flow of energy, of signals or of material.
- **R:** Restricting or stabilizing motion or a flow of energy or material.
- **S:** Converting a manual operation into a signal for further processing.
- **T:** Conversion of energy maintaining the kind of energy.
- **U:** Keeping objects in a defined position.
- **V:** Processing (treating) of material or products.
- **W:** Guiding or transporting from one place to another.
- **X:** Connecting objects

**AAAA:** Alphanumeric code which identify the element.

### Seealso

For more information about how to define auto numbering patterns, refer to [project auto numbering properties](#) section.

For more information about how to manage the codification of conductors, refer to [add element](#) section.

## Element collection

### What is a collection?

An element collection is a database where all element files are stored and classified. The element collection gives the information about the element name, category (folder); sub-categories (sub-folders) and category or sub-category path in the file system.

QElectroTech has two different element collections integrated, [QET collection](#) and [User collection](#).

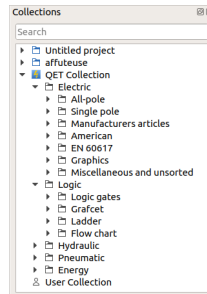

Figure: Collection panel

QElectroTech displays also a third collection in the [collections panel](#) when a project is opened, the [project collection](#). This collection is not part from the software structure and it is treated automatically by QElectroTech during the draw proces in the [workspace](#).

### QET collection

The QET collection is the default collection from QElectroTech. This collection is protected and the user can only read it, the QET collection cannot be edited. The user cannot add any [element](#), any category or sub-category and cannot re-organize the [elements](#) in the database.

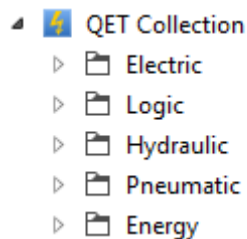

Figure: QET collection tree at collection panel

The QET collection has the following categories:

- Electric:** Collection of electrical components (motors, converters, switches, electrical protections, etc.)
- Logic:** Logic signal symbols (AND, OR, NOT, NOR, etc.), Grafcet symbols, Ladder symbols and flow char symbols.
- Hydraulic:** Collection of hydraulic components (Pumps, cylinders, pressure limit valves, pressure relief valves, directional valves, etc.)
- Pneumatic:** Collection of hydraulic components (Compressor, cylinders, air filters, directional valves, etc.)
- Energy:** Collection of elements used at the energy field (pumps, turbines, solar panels, heat exchangers, etc.)

### User collection

The User collection is the QElectroTech collection where the user can create and organize [elements](#), the user is allowed to read and edit the collection. The actions allowed at the user collection are:

1. Add new elements.
2. Edit elements from the collection.



3. Delete elements from the collection.
4. Create new categories / folders.
5. Create new sub-categories / sub-folders.
6. Delete categories or sub-categories.
7. Re-organize the collection.

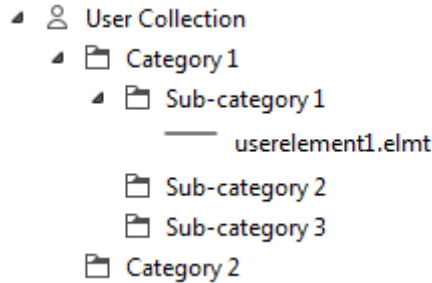

Figure: Example user collection tree at collection panel

### Project collection

The project collection is the only collection which is not part from the software structure. A project collection is an element collection that is part of the project file, each **project** has its own element collection.

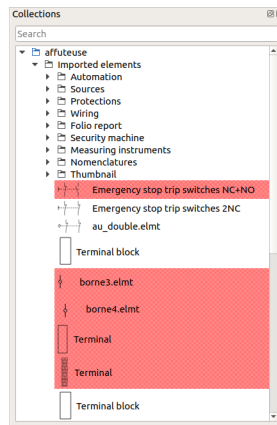

Figure: QElectroTech project collection

QElectroTech does not allow working in this collection, the user cannot add or delete any element, category or sub-category manually. The user can only read the category or sub-category properties and use the collection to access to the **elements** of the **project** to edit them.

The elements are copied from **QET** or **User** collection by QElectroTech automatically when the user introduces a new **element** at one **folio** of the **project**. If the **element** has already been used previously, QElectroTech does not add the **element** to the project collection again.

If one **element** is deleted from the **project**, QElectroTech does not delete the **element** from the project collection automatically, the **element** is remarked in red. **Cleaning the project** deletes all elements from the project collection that are not used inside the project and reduces the size of the project file.

### Create category

Working with collections can only be done from **collections panel**.

#### Note

Select **Settings > Display > Collections** menu item to display the **collections panel**.

QElectroTech allows creating categories at some collection. The user has only read rights at [QET collection](#), the user can create categories at [User collection](#).

1. Right click on [User collection](#) or at a category / sub-category from the [User collection](#).

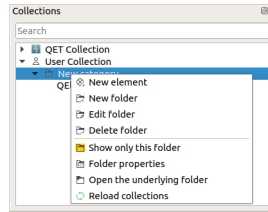

Figure: Options at folder

2. Click the option **New folder** to open **Add a new category** PopUP window.

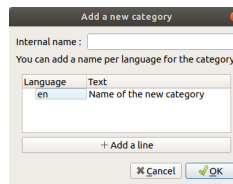

Figure: New category PopUP window

3. Define the internal name for the file system.
4. Define the category name that will be displayed at the collection tree, it can be defined in many languages.
5. Press **OK** to add the new category / sub-category.

### Note

QElectroTech works according [ISO 639-1](#) norm. The folder name language is defined using 2 letter code which should be used at the language column from the folder internal name table.

### Edit category

Working with collections can only be done from [collections panel](#).

### Note

Select **Settings > Display > Collections** menu item to display the [collections panel](#).

1. Right click on the user collection or at a category from the collection which should be edited.

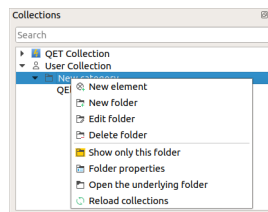

Figure: Options at folder

2. Click the option **Edit folder** to open **Add a new category** PopUP window.

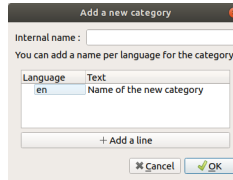

Figure: New category PopUP window

3. Edit the category name or add a new translation from the category name pressing **Add a line**.
4. Press **OK** to change the category properties.

### Note

QElectroTech works according [ISO 639-1](#) norm. The folder name language is defined using 2 letter code which should be used at the language column from the folder internal name table.

### Delete category

Working with collections can only be done from [collections panel](#).

### Note

Select **Settings > Display > Collections** menu item to display the [collections panel](#).

QElectroTech allows deleting categories from some collection. The user has only read rights at QET element collection, the user can delete categories from all collections except QET collection.

1. Right click on the category / sub-category from the collection that should be deleted.

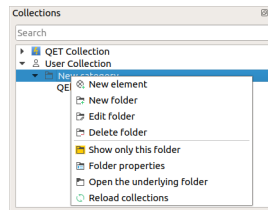

Figure: Options at folder

2. Click the option **Delete folder** to delete the category / sub-category.
3. A PopUP confirmation window will be displayed, press **OK** to confirm and delete the category / sub-category.

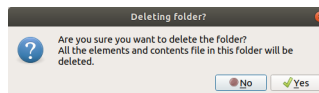

Figure: Deleting PopUP window confirmation

### Warning

Be sure about what should be deleted, the category / sub-category and all elements will be deleted from the collection and file system.

### Folder properties

At QElectroTech folder and category are the same. The properties from a folder are:

- Number of elements in the folder.
- Number of sub-folders (sub-categories) in the folder.
- Internal QElectroTech collection path from the folder.
- File system path from the folder.

Working with collections can only be done from [collections panel](#).

## Note

Select **Settings > Display > Collections** menu item to display the [collections panel](#).

1. Right click on the category (folder) from the collection whose properties should be displayed.

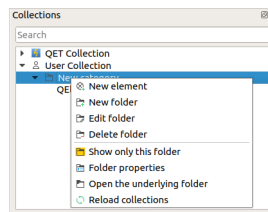

Figure: Options at folder

2. Click the option **Folder properties** to display the PopUP window which shows the folder properties.

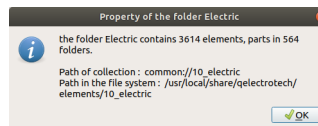

Figure: Folder properties PopUP window

## Create element

Working with collections can only be done from the collections panel. Before starting to work with collections, the collections panel has to be displayed.

## Note

Select **Settings > Display > Collections** menu item to display the Collections panel.

QElectroTech allows creating element at some collection. The user has only read rights at QET element collection, the user can create element at all collections except QET collection.

There is two different ways to create a new element at the user collection. A new element can be created from zero or from an already existing element from the QET or user collection.

## Create element from zero

1. Right click on the user collection or at the category / sub-category from the collection where the new element should be added.

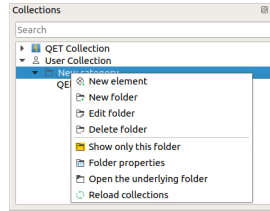
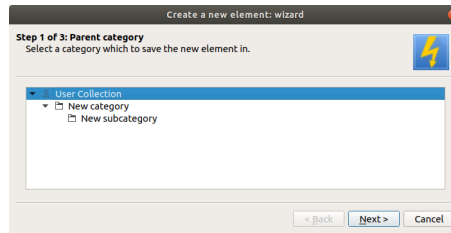

Figure: Options at folder

2. Click the option **New element** to start the element creation.
3. Confirm or change the category from the element.



4. Define the element file name.

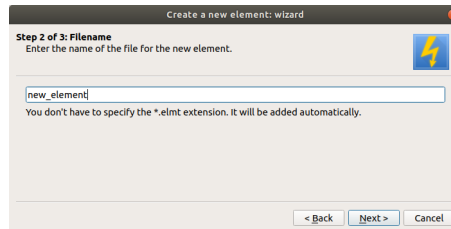

Figure: File name definition PopUP window

5. Define the element name for the collection and project tree. It can be defined in many languages.

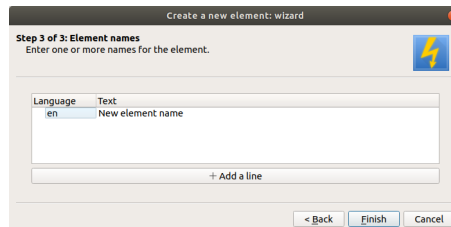

Figure: Element name definition PopUP window

### Note

QElectroTech works according [ISO 639-1](#) norm. The element name language is defined using 2 letter code which should be used at the language column from the folder internal name table.

6. Once the element editor PopUP window is opened, design the symbol element and define the properties.
7. Save the element and it will appear at the collection.

### Seealso

For more information about the element editor, refer to [Element editor](#) section.

## Create an element from an existing element

1. Right click on the element which will be used as base for the new element.

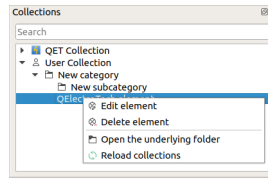
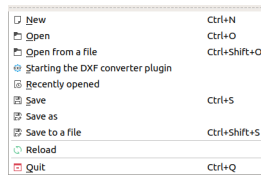
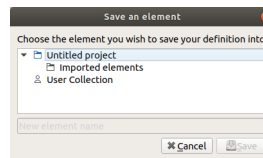

Figure: Options at element

2. Click the option **Edit element** to open the element at the element editor.
3. Select **File > Save as** menu item to open the save window.



4. Choose the element category at the collection tree.
5. Define the file name for the element.
6. Press the button **Save**.



## Edit element

Working with collections can only be done from the collections panel. Before starting to work with collections, the collections panel has to be displayed.

### Note

Select **Settings > Display > Collections** menu item to display the Collections panel.

QElectroTech allows editing existing element from some collection. The user has only read rights at QET element collection, the user can edit already existing element from all collections except QET collection element.

1. Right click on the element which should be edited.

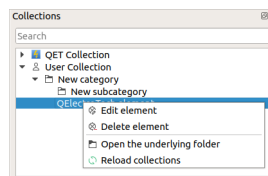

Figure: Options at element

2. Click the option **Edit element** to open the element at the element editor.
3. Make the changes desired and save them.

Seealso

For more information about the element editor, refer to [element editor](#) section.

### Delete element

Working with collections can only be done from the collections panel. Before starting to work with collections, the collections panel has to be displayed.

#### Note

Select **Settings > Display > Collections** menu item to display the Collections panel.

QElectroTech allows deleting element from some collection. The user has only read rights at QET element collection, the user can delete element from all collections except QET collection.

1. Right click on the element which should be deleted.

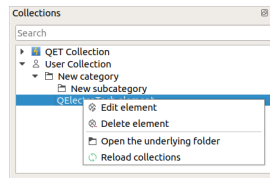

Figure: Options at element

2. Click the option **Delete element** to delete the element.

#### Warning

Be sure about your intention to delete, the element will be deleted from the collection and from the file system.

### Element parts

#### Line

##### Create line

The line can only be added to [workspace](#) from [toolbar](#).

1. Select the icon  from [toolbar](#) to add a line.
2. Click on the initial point from the line in the [workspace](#).
3. Click on the end point from the line in the [workspace](#).

#### Note

If the [toolbar](#) is not displayed, it can be displayed from **Settings > Display > Parts**.

### Line properties

Element part properties can be displayed from [information panel](#) when the part is selected.

## Note

If the [information panel](#) is not displayed, it can be displayed from **Settings > Display > Information**.

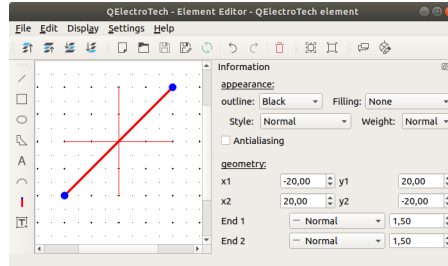

Figure: QElectroTech line from element

QElectroTech allows customizing different line properties:

### Appearance:

**Color:** The outline and filling color of the part can be defined from a list of pre-defined colors. At the case of the line part the filling color is **None**.

**Style:** The outline representation type can be chosen between: Normal (Continuous), Dashed, Dotted or, Dots and dashes.

**Thickness:** The outline thickness (Weight) can be chosen between: None, Thin, Normal, Strong or High.

### Geometry:

**Coordinates:** The start and end point coordinates (x, y) can be defined.

**End point:** The extrem point from the line can be represented individually as:

**Normal:** The extrem point is represented as the rest of the line, there is no different representation for the end point.

**Simple arrow:** The extrem point is represented as a filled arrow.

**Triangle arrow:** The extrem point is represented as an empty triangle arrow.

**Circle:** The extrem point is represented as an empty circle.

**Diamond:** The extrem point is represented as an empty diamond.

## Rectangle

### Create rectangle

The rectangle can only be added to [workspace](#) from [toolbar](#).

1. Select the icon  from [toolbar](#) to add a rectangle.
2. Click on the initial vertex from the rectangle in the [workspace](#).
3. Click on the end vertex from the rectangle in the [workspace](#).

## Note

If the [toolbar](#) is not displayed, it can be displayed from **Settings > Display > Parts**.



## Rectangle properties

Element part properties can be displayed from [information panel](#) when the part is selected.

### Note

If the [information panel](#) is not displayed, it can be displayed from **Settings > Display > Information**.

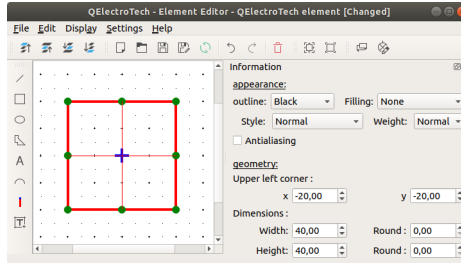

Figure: QElectroTech rectangle part from element

QElectroTech allows customizing different rectangle properties:

#### Appearance:

**Color:** The outline and filling color of the part can be defined from a list of pre-defined colors.

**Style:** The type of outline representation can be chosen between: Normal (Continuous), Dashed, Dotted or, Dots and dashes.

**Thickness:** The outline thickness (Weight) can be chosen between: None, Thin, Normal, Strong or High.

#### Geometry:

**Coordinates:** The upper left vertex coordinates (x, y) can be defined.

**Dimensions:** The width and the height of the rectangle can be defined. The tangent point at the vertical and horizontal edges can also be defined at the case that round vertex is desired.

## Rounding rectangle vertices

QElectroTech allows rounding the rectangle vertices from [information panel](#) or [workspace](#).

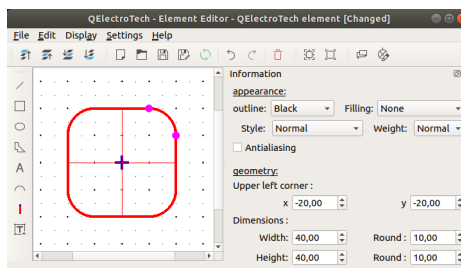

Figure: QElectroTech rounded rectangle part from element

## Rounding rectangle vertices from information panel

1. Select the rectangle to display the rectangle properties at [information panel](#).
2. Define the distance between the vertex and the intersection point at the vertical edges.
3. Define the distance between the vertex and the intersection point at the horizontal edges.
4. Press **intro**.
5. **Select none** from **Edit** menu or use **Ctrl + Shift + a** keyboard shortcut.

## Rounding rectangle vertices from workspace

1. Select the rectangle drawn at [workspace](#). The rectangle outlines change to red color and the vertices and middle edge point to blue.
2. Select the rectangle again. The outlines continue in red and the points change to green color.
3. Select the rectangle for third time. The outlines continue in red and only one vertex is displayed, the color is pink.
4. Displace the pink points around the horizontal and vertical edge.
5. **Select none** from **Edit** menu or use `Ctrl + Shift + a` keyboard shortcut.

## Ellipse

### Create ellipse

The ellipse can only be added to [workspace](#) from [toolbar](#).

1. Select the icon  from [toolbar](#) to add an ellipse.
2. Click the position from the ellipse center point in the [workspace](#).
3. Click the position from the control point of the ellipse in the [workspace](#).

### Note

If the [toolbar](#) is not displayed, it can be displayed from **Settings > Display > Parts**.

### Ellipse properties

Element part properties can be displayed from [information panel](#) when the part is selected.

### Note

If the [information panel](#) is not displayed, it can be displayed from **Settings > Display > Information**.

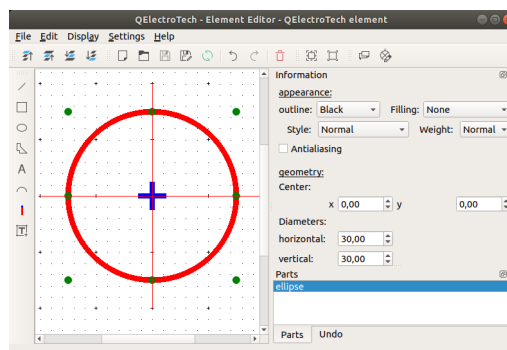

Figure: QElectroTech ellipse part from element

QElectroTech allows customizing different ellipse properties:

**Appearance:**

**Color:** The outline and filling color of the part can be defined from a list of pre-defined colors.

**Style:** The outline representation type can be chosen between: Normal (Continuous), Dashed, Dotted or, Dots and dashes.

**Thickness:** The outline thickness (Weight) can be chosen between: None, Thin, Normal, Strong or High.

**Geometry:**

**Coordinates:** The ellipse center point coordinates (x, y) can be defined.

**Dimensions:** The horizontal and vertical (minimum and maximum or maximum and minimum) diameters from the ellipse can be defined.

**Polygon**

**Create polygon**

The polygon can only be added to [workspace](#) from [toolbar](#).

1. Select the icon  from [toolbar](#) to add a polygon.
2. Click on the initial point from the polygon in the [workspace](#).
3. Click on the rest of point from the polygon in the [workspace](#).
4. Double click on the end position of the polygon to finish the polygon edition.

**Note**

If the [toolbar](#) is not displayed, it can be displayed from **Settings > Display > Parts**.

**Polygon properties**

Element part properties can be displayed from [information panel](#) when the part is selected.

**Note**

If the [information panel](#) is not displayed, it can be displayed from **Settings > Display > Information**.

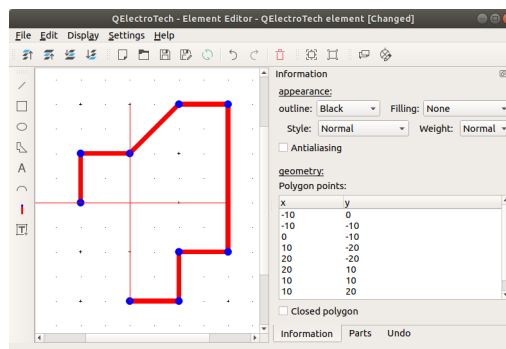

Figure: QElectroTech polygon part from element

QElectroTech allows customizing different polygon properties:

**Appearance:**

**Color:** The outline and filling color of the part can be defined from a list of pre-defined colors. At the case of an open polygon part the filling color is **None**.

**Style:** The outline representation type can be chosen between: Normal (Continuous), Dashed, Dotted or, Dots and dashes.

**Thickness:** The outline thickness (Weight) can be chosen between: None, Thin, Normal, Strong or High.

**Geometry:**

**Type of polygon:** QElectroTech has two different types of polygons, open polygon which is assimilated to a group of connected lines and close polygon which is assimilated to closed geometry as the rectangle.

**Coordinates:** The polygon points coordinates (x, y) can be defined and stored in a list.

**Text field**

The normal text field is an object that displays a static text. Once the [element](#) has been created, the text can only be changed if the [element](#) is edited. Any different value can be introduced from outside of the [element editor](#).

**Create text**

The text field can only be added to [workspace](#) from [toolbar](#).

1. Select the icon  from [toolbar](#) to add a text field.
2. Click the positional point from the text in the [workspace](#).

**Note**

If the [toolbar](#) is not displayed, it can be displayed from **Settings > Display > Parts**.

**Text properties**

Element part properties can be displayed from [information panel](#) when the part is selected.

**Note**

If the [information panel](#) is not displayed, it can be displayed from **Settings > Display > Information**.

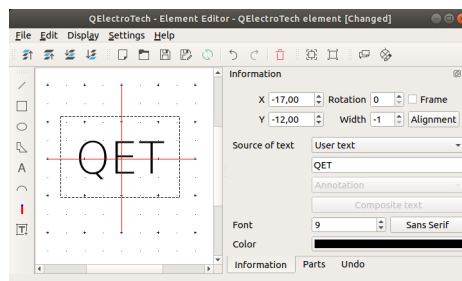

Figure: QElectroTech text field part from element

QElectroTech allows customizing different text properties:

**Placement:**

**Position:** The text coordinates (x, y) can be defined.

**Text angle:** The text display angle can be defined in the range of 0 to 360 degrees.

**Content:****Size:** The text size can be defined.**Color:** The color text can be chosen between black and white.**Arc****Create arc**

The arc can only be added to [workspace](#) from [toolbar](#).

1. Select the icon  from [toolbar](#) to add an arc.
2. Click at the position from the start point of the arc in the [workspace](#).
3. Click at the position from the end point of the arc in the [workspace](#). The default arc has always an angle of 90 degrees.

**Note**

If the [toolbar](#) is not displayed, it can be displayed from **Settings > Display > Parts**.

**Arc properties**

Element part properties can be displayed from [information panel](#) when the part is selected.

**Note**

If the [information panel](#) is not displayed, it can be displayed from **Settings > Display > Information**.

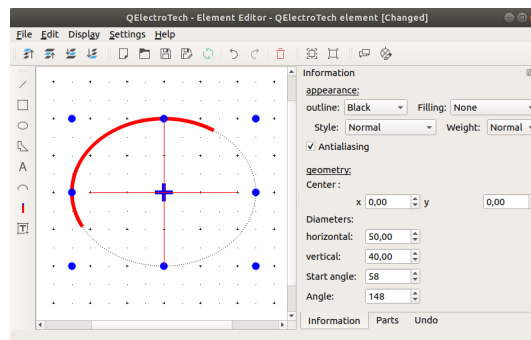

Figure: QElectroTech arc part from element

QElectroTech allows customizing different arc properties:

**Appearance:****Color:** The outline color and the filling color of the part can be defined from a list of pre-defined colors. At the case of the arc part the filling color is **None**.**Style:** The type of outline representation can be chosen between: Normal (Continuous), Dashed, Dotted or, Dots and dashes.**Thickness:** The outline thickness (Weight) can be chosen between: None, Thin, Normal, Strong or High.

**Geometry:**

**Coordinates:** The coordinates (x, y) from the ellipse center point can be defined.

**Dimensions:** The horizontal and vertical (minimum and maximum or maximum and minimum) diameters from the ellipse can be defined.

**Point:** The position of initial point and end point are defined as angle of the radius between the center and the respective point with the horizontal diameter. The angle value follows the mathematical rules, anti-clockwise for positive angles.

**Arc extreme points definition**

QElectroTech allows defining the arc extreme points from [information panel](#) or [workspace](#).

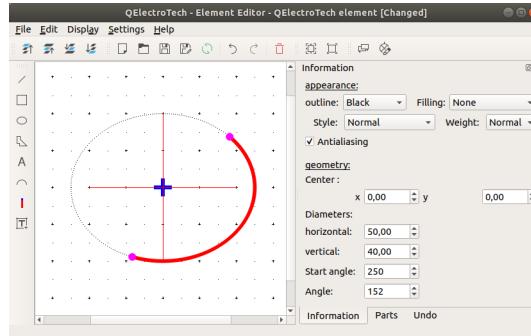

Figure: QElectroTech arc extreme point

**Arc extreme points definition from information panel**

1. Select the arc to display the rectangle properties at [information panel](#).
2. Define the start angle, the angle from the diameter of the start point and the horizontal axes.
3. Define the angle from the initial point and the end point of the arc.
4. Press intro.
5. **Select none** from **Edit** menu or use `Ctrl + Shift + a` keyboard shortcut.

**Arc extreme points definition from workspace**

1. Select the arc drawn at the [workspace](#). The arc line changes to red color and the control of the arc ellipse point to blue.
2. Select the arc again. The line continues in red and the points change to green color.
3. Select the arc for third time. The line continues in red and at this time only one extreme points are, the color is pink.
4. Displace the pink points around the ellipse outline.
5. **Select none** from **Edit** menu or use `Ctrl + Shift + a` keyboard shortcut.

**Terminal**

A terminal is a part from the [element](#) that will allow a connection with one [conductor](#) during the schema creation.

**Create terminal**

The terminal can only be added to [workspace](#) from [toolbar](#).

1. Select the icon  from [toolbar](#) to add a terminal.
2. Click on the initial point from the terminal in the [workspace](#) to add the terminal.

**Note**

If the [toolbar](#) is not displayed, it can be displayed from **Settings > Display > Parts**.

**Terminal properties**

Element part properties can be displayed from [information panel](#) when the part is selected.

**Note**

If the [information panel](#) is not displayed, it can be displayed from **Settings > Display > Information**.

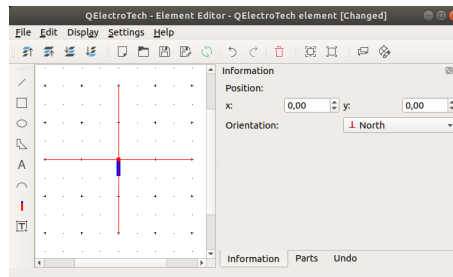

Figure: QElectroTech terminal part from element

QElectroTech allows customizing different terminal properties:

- Position:** The start point coordinates (x, y) can be defined.
- Orientation:** The exit direction from the connector can be defined. The four possible orientations are North, East, South and West.

**Dynamic text**

The dynamic text field is an object that displays a text that is coming from a variable value. The text value is changing with the variable is changed, editing the part is not necessary to change the text content.

**Create dynamic text**

The text field can only be added to [workspace](#) from [toolbar](#).

1. Select the icon  from [toolbar](#) to add a dynamic text field.
2. Click the positional point from the text field in the [workspace](#).

**Note**

If the [toolbar](#) is not displayed, it can be displayed from **Settings > Display > Parts**.

**Dynamic text properties**

Element part properties can be displayed from [information panel](#) when the part is selected.

**Note**

If the [information panel](#) is not displayed, it can be displayed from **Settings > Display > Information**.

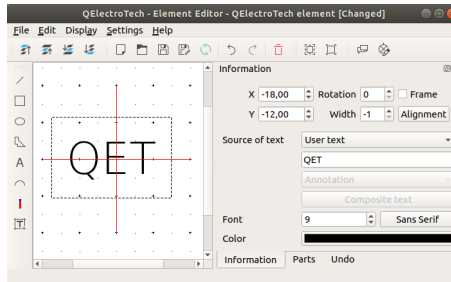

Figure: QElectroTech dynamic text field part from element

QElectroTech allows customizing different text properties:

**Placement:**

- Position:** The dynamic text coordinates (x, y) can be defined.
- Rotation:** The text display angle can be defined in the range of 0 to 360 degrees.
- Frame:** The possibility to display the text inside a rectangle frame is provided.
- Alignemnt:** The text position inside the frame can be defined. Left, center or right and top, middle or bottom.

**Content:**

- Source:** The source content can be user text (similar to static text), element information parameter or composite text.
- Size:** The text size can be defined.
- Color:** The text color can be choosed from RGB color code database.

## Element cross reference

E-CAD softwares like QElectroTech allow creating projects where different type of subsystems or/and disciplines are combined. This means that one device can be represented many times.

An example of combining subsystems is an electrical control system where the command system and the power system are combined. The control coil from a power contactor is represented at the control command system and the electrical contactors are represented at the electrical power system.

An example of combining different disciplines is the representation of an hydraulic valve at the electrical schema and at the hydraulic schema.

The examples mentioned before are situations where different QElectroTech elements introduced at the project are representing the same device and later on they have to be listed as one item at the Bill Of Materials (BOM). For this reason, QElectroTech allow defining Master and Slave elements that later on will be linked. The link between master and slave elements is known at QElectroTech as cross reference.

## Cross reference at master element

A master element can have many slave element linked. QElectroTech allows that one master element has more than one cross reference defined. This characteristic is similar to the physical devices, the component which manage the control signal can define the action from many different components of the device.

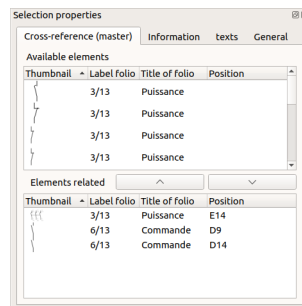

Figure: QElectroTech master element cross reference



The master element is the element which should appear at the Bill of Materials (BOM), it is the element with all the information. All slave elements linked are following the master element.

### ***Cross reference at slave element***

A slave element can only have one master element linked. QElectroTech does not allow that one slave element has more than one cross reference defined.

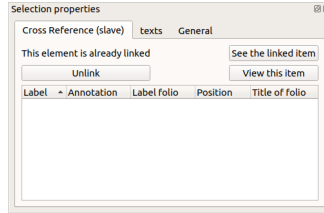

Figure: QElectroTech slave element cross reference

A slave element has only the properties which define how the element should be represented, the information from the element is not necessary, the master element is the element which defines the device and the element which appear at the bill of materials (BOM). The information about the device can only be found at the master element.

### ***Element editor***

#### ***What is the element editor?***

The element editor is the editor provided by QElectroTech to modify existing elements from the user collection and create new elements to the collection.

The element editor is displayed as a PopUP window and looks like the figure below.

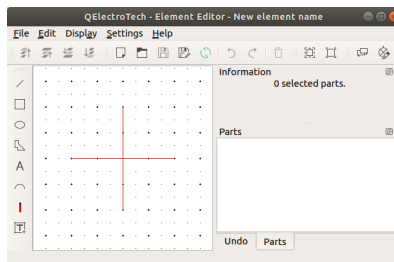

Figure: QElectroTech element editor

### ***Interface element editor***

#### ***Element editor window***

The element editor window is a PopUP window from QElectroTech. It has also been designed using Qt framework and widget toolkit. The window from QElectroTech element editor is the same for all platforms where it is available (Windows, Linux/Unix and MacOS). The window from the element editor contains the following areas:

1. Menu bar
2. Toolbars
3. Drawing area
4. Panels
5. Help bar

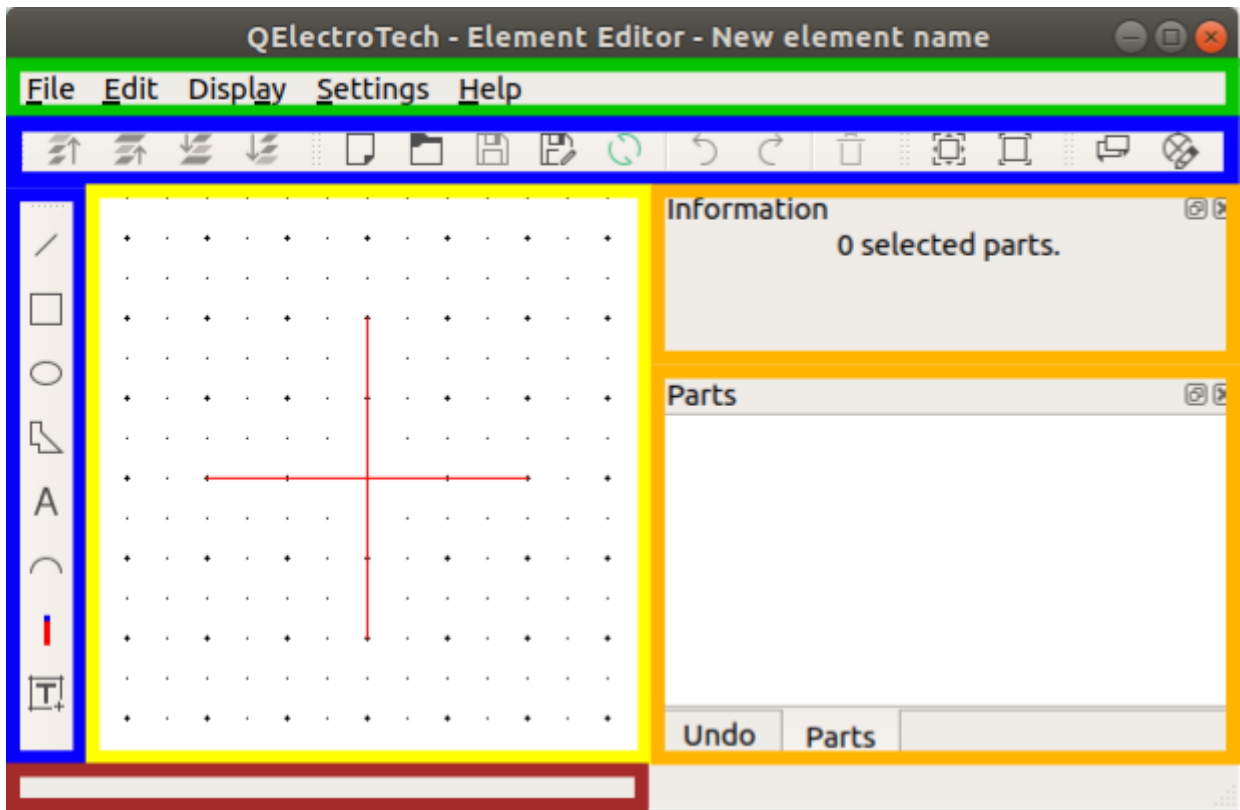

Figure: QElectroTech Element editor window

### Element editor menu bar

The menu bar is placed at top from element editor window. The element editor contains the menus File, Edit, Display, Settings, and Help. Each menu provides many different options.

### Note

A brief description of each menu option can be read from [help](#) or [information tool bar](#) by hovering over the option with the cursor.

### File menu

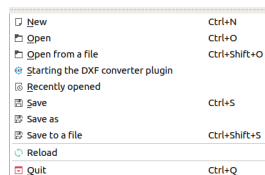







Figure: QElectroTech file menu

Option	Function	Keyboard shortcut	Icon
New	Creates a new element	Ctrl + n	
Open	Opens an existing element from collection	Ctrl + o	
Open from a file	Opens an existing element from file	Ctrl + o	
Starting the DXF converter plugging	Import element from DXF file	Ctrl + o	
Recently opened	Open an element from history (recently opened files)	Ctrl + s	

## Element

Save	Saves the current element changes (overwrites)	Ctrl + s	
Save as	Saves the element as a new element from a library		
Save to a file	Saves the Element as a different file on disk	Ctrl + Shift + x	
Reload	Reloads the opened element (all changes which are not saved are lost)	Ctrl + p	
Quit	Quits QElectroTech Element editor	Ctrl + q	

## Edit menu

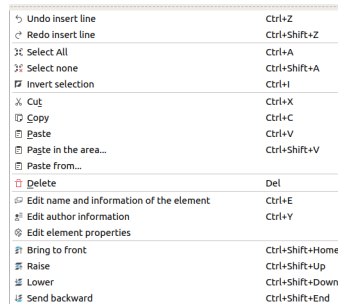



















Figure: QElectroTech edit menu

Option	Function	Keyboard shortcut	Icon
Undo	Undoes the previous action	Ctrl + z	
Redo	Restores the undone action	Ctrl + y	
Select All	Selects all elements on the folio	Ctrl + a	
Select none	Deselect all elements on the folio	Ctrl + Shift + a	
Invert selection	Inverts selection of elements	Ctrl + i	
Cut	Puts selected elements into the clipboard	Ctrl + x	
Copy	Copies selected elements	Ctrl + c	
Paste	Pastes elements from the clipboard into the folio	Ctrl + v	
Paste in the area	Pastes elements from the clipboard into the folio	Ctrl + v	
Paste from	Pastes elements from the clipboard into the folio	Ctrl + v	
Delete	Removes selected elements from the folio	Del	
Edit name and information of the element	Rotates selected elements and texts	Space	
Edit author information	Rotates selected texts to a specific angle	Ctrl + Space	
Edit element properties	Finds the selected element in the collections panel		
Bring to front	Brings the selection (s) to front	Ctrl + Shift + Home	
Raise	Approachs the selection (s)	Ctrl + Shift + Up	

Lower	Moves away the selection (s)	Ctrl + Shift + Down	
Send backwards	Sends in the backwards the selection (s)	Ctrl + Shift + End	

**Display menu**

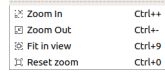





Figure: QElectroTech display menu

Option	Function	Keyboard shortcut	Icon
Zoom In	Expands the workspace	Ctrl + +	
Zoom Out	Shrinks the workspace	Ctrl + -	
Fit in view	Adjusts the zoom on exactly trhe part of the workspace	Ctrl + 9	
Reset zoom	Restores default zoom level	Ctrl + 0	

**Settings menu**

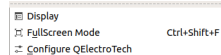





Figure: QElectroTech settings menu

Option	Function	Keyboard shortcut	Icon
Display	Displays or hides toolbars and panels		
Full screen mode	Displays QElectroTech in full screen mode	Ctrl + Shift + f	
Configure QElectroTech	Allows specifying various parameters for QElectroTech		

**Help menu**

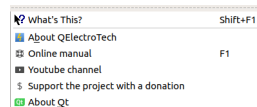







Figure: QElectroTech help menu

Option	Function	Keyboard shortcut	Icon
What's This?	Enquires main menu options	Shift + f1	
About QElectroTech	Displays information about QElectroTech		
Online manual	Lauches the default browser to the online manual of QElectroTech	f1	
Youtube channel	Lauches the default browser on the Youtube channel of QElectroTech		
Support the project with a donation	Lauches the default browser on the QElectroTech donation paypal account		
About Qt	Displays information about Qt library		

### Element editor toolbars

In addition to the different menus, QElectroTech provides also toolbars. The toolbars are groups of buttons with icons which initiate an action. In general, these buttons have its counterpart at one of the menus from the [menu bar](#).

The different toolbars can be hidden or placed in one or more rows below the [menu bar](#). The toolbars can also be placed on column at the left or right side from the main window.

#### Note

To help the user, a tooltip is displayed when the arrow is placed on each button.

### Toolbar Tools



Figure: QElectroTech element editor toolbar Tools

The different buttons from toolbar **Tools** are:

Tool	Function	Keyboard shortcut	Icon
New	Creates a new element	Ctrl + n	
Open	Opens an existing element from collection	Ctrl + o	
Save	Saves the current element changes (overwrites)	Ctrl + s	
Save as	Saves the element as a new element from a library		
Reload	Reloads the opened element (all changes which are not saved are lost)	Ctrl + p	
Undo	Undoes the previous action	Ctrl + z	
Redo	Restores the undone action	Ctrl + y	
Delete	Removes selected elements from the folio	Del	

#### Note

Select **Settings > Display > Tools** menu item to display or hidden the toolbar **Tools**.

### Toolbar Display



Figure: QElectroTech element editor toolbar Display

The different buttons from toolbar **Display** are:

#### Note



Select **Settings > Display > Display** menu item to display or hidden the toolbar **Display**.

### Toolbar Element



Figure: QElectroTech element editor toolbar Element

The different buttons from toolbar **Element** are:

Tool	Function	Keyboard shortcut	Icon
Information	Edit name and information of the element	Ctrl + e	
Properties	Edit element properties		

### Note









Select **Settings > Display > Diagrams** menu item to display or hidden the toolbar **Element**.

### Toolbar Parts



Figure: QElectroTech element editor toolbar Parts

The different buttons from toolbar **Parts** are:

Tool	Function	Keyboard shortcut	Icon
Line	Add line to the workspace		
Rectangle	Add rectangle to the workspace		
Ellipse	Add ellipse to the workspace		
Polygon	Add polygon to the workspace		
Text	Add text field to the workspace		
Arc	Add arc to the workspace		
Terminal	Add terminal to the workspace		
Text field	Add dynamic text field to the workspace		

### Note



Select **Settings > Display > Diagrams** menu item to display or hidden the toolbar **Parts**.

### Toolbar Depth



Figure: QElectroTech element editor toolbar Depth

The different buttons from toolbar **Depth** are:

Tool	Function	Keyboard shortcut	Icon
Bring forward	Brings the selection (s) to front	Ctrl + shift + Home	
Raise	Approachs the selection (s)	Ctrl + shift + Up	
Lower	Moves away the selection (s)	Ctrl + shift + Down	

Send backwards	Sends in the backwards the selection (s)	Ctrl + shift + E nd	
----------------	--	------------------------	---

**Note**

Select **Settings > Display > Diagrams** menu item to display or hidden the toolbar **Depth**.

**Drawing area**

The drawing area or workspace, is the area where the graphical representation of the elements is created.

The drawing area or workspace looks as follow:

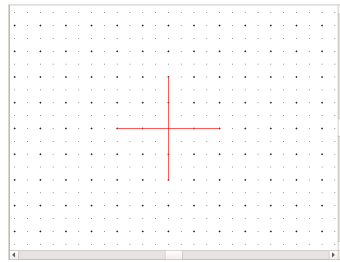

Figure: QElectroTech element editor workspace

The scrollbars are not appearing when the element editor is displayed, rolling the wheel from the mouse to zoom in and th scrollbars will appear.

**Element editor panels**

**Parts panel**

The Parts panel lists all **parts** (lines, terminals, rectangles, dynamic texts, etc.) which make up the **element**.

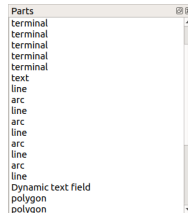

Figure: QElectroTech element editor Parts panel

To display the Parts panel

1. Select **Settings > Display > Parts** menu item to display the Parts panel.

**Selection properties panel**

The Selection properties panel displays the appearance and geometry properties from the selected **part** (line, terminal, rectangle, dynamic text, etc.).

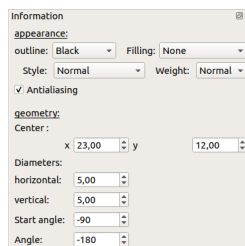

Figure: QElectroTech element editor Selection properties panel

## Element

To display the Selection properties panel:

1. Select **Settings > Display > Selection properties** menu item to display the Selection properties panel.

### Undo panel

The Undo panel lists all actions made by the user inside the [element editor](#) from last save.

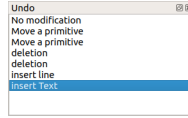

Figure: QElectroTech element editor Undo panel

To display the Undo panel:

1. Select **Settings > Display > Undo** menu item to display the Undo panel.

### Seealso

For more information about the actions for which the Undo panel can be useful, refer to [Undo panel](#) section from [QElectroTech main window](#).

### Help bar

The help bar, also known as information bar, is the space below control tabs, the bottom left corner from main window. It is very useful for beginners of QElectroTech in the way that it gives information about the field that is pointed by the cursor. A user can learn about a field by simply pointing it with the mouse and reading the information from help bar.

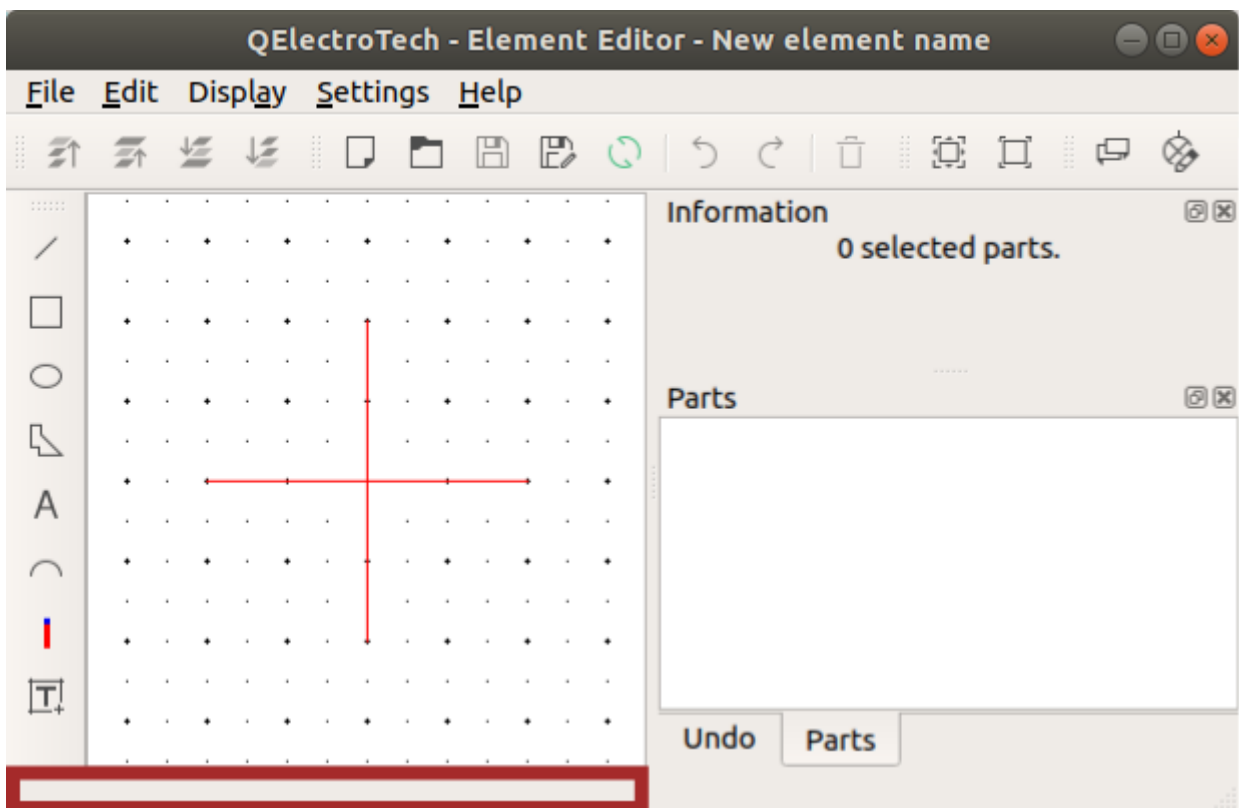

Figure: QElectroTech element editor help bar

### Open element editor



QElectroTech allows displaying the element editor PopUP window by creating a new element or by editing an existing element.

### Open element editor by creating a new element

1. Refers to the section **link** for opening the element editor by creating a new element from the project panel.

### Open element editor by editing an element

1. Refers to the section **Link** for opening the element editor by editing an element from collection onle.
2. Refers to section **Link** for opening the element editor by editing an element from the workspace.

### Save element

The current **element** can be saved from **menu bar**, **toolbar** and using the corresponding keyboard shortcut.

One **element** is only conformed by one file with format `.elmt`. The `.elmt` extension is the native extension from QElectroTech **elements**.

### Save element from menu bar

1. Select **File > Save** menu item to save the element changes.

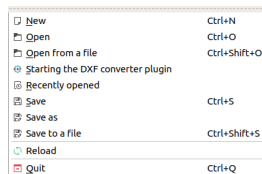

Figure: QElectroTech element editor file menu

At the case that the opened **element** has to overwrite an existing **element** or it has to be saved as a new **element**:

1. Select **File > Save as** menu item to display the **Save as element** PopUP window.

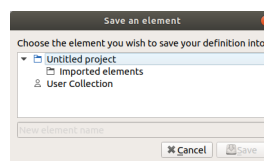

Figure: QElectroTech element editor save as PopUP window

2. Select the **element** which should be overwritten or the **category** and the name for the new **element**.
3. Press the **Save** button to save the **element** and close the PopUP window.

The **element** can also be directly saved as a new file in the Hard Disk directory desired:

1. Select **File > Save to a file** menu item to display the file system PopUp window.
2. Select the directory and the name from the element file.
3. Press **Save** button to save the **element** and close the PopUP window.

### Save element from toolbar

1. Select the icon  from **toolbar** to save the element changes.

At the case that the opened **element** has to overwrite an existing **element** or it has to be saved as a new **element**:

1. Select the icon  from **toolbar** to display the **Save as element** PopUP window.

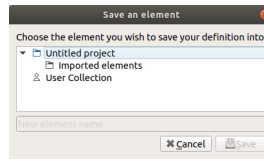

Figure: QElectroTech element editor save as PopUP window

2. Select the **element** which should be overwritten or the **category** and the name for the new **element**.
3. Press the **Save** button to save the **element** and close the PopUP window.

### Note

If the **toolbar** is not displayed, it can be displayed from **Settings > Display > Tools**

### Save element using keyboard shortcut

QElectroTech allows using keyboard shortcut to increase the working efficiency.

1. Press **Ctrl + s** to save the element changes.

### Seealso

For more information about QElectroTech keyboard shortcut, refer to **menu bar** section.

### Quit element editor

The user can close **QElectroTech element editor** at any time. The user does not need to **save** the changes on the **element** before closing it.

If the current work wants to be saved before closing the **element editor**, refer to **save** section. Even so, QElectroTech display an automatic message to **save** the current job if any modification has been created.

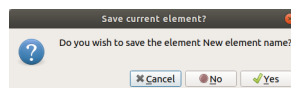

Figure: QElectroTech element editor save message

### Exit QElectroTech element editor from menu bar

1. Select **File > Quit** menu item to quit QElectroTech element editor.

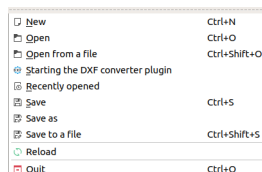

Figure: QElectroTech element editor file menu

### Exit QElectroTech element editor using keyboard shortcut

QElectroTech allows using keyboard shortcut to increase the working efficiency.

1. Press **Ctrl + q** to quit QElectroTech element editor.

**See also**

For more information about QElectroTech keyboard shortcut, refer to [menu bar](#) section.

### **Create or edit elements**

#### **Graphic definition**

#### **Working with parts**

#### **Add part to element**

Adding parts to the [drawing area](#) from the [element editor](#) can only be done from [parts toolbar](#).

### **Note**

If the [toolbar](#) is not displayed, it can be displayed from **Settings > Display > Parts**.

For more information about how to add each type of part ([Line](#), [Rectangle](#), [Ellipse](#), [Arc](#), [Polygon](#), [Terminal](#), [text](#) and [dynamic text field](#)), refer to the [element part](#) section.

#### **Select parts from workspace**

##### **Select one part**

At QElectroTech, one [part](#) ([Line](#), [Rectangle](#), [Ellipse](#), [Arc](#), [Polygon](#), [Terminal](#), [text](#) and [dynamic text field](#)) from the [workspace](#) can be selected by a simple left click on the [part](#).

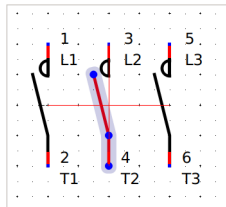

*Figure: QElectroTech element editor workspace*

##### **Select multiple parts**

As many CAD tools, many [parts](#) ([Line](#), [Rectangle](#), [Ellipse](#), [Arc](#), [Polygon](#), [Terminal](#), [text](#) and [dynamic text field](#)) from [workspace](#) can be selected at the same time.

##### **Select multiple objects using keyboard and mouse**

QElectroTech allows selecting multiple [parts](#) from the [workspace](#) combining the use of the keyboard and mouse.

1. [Select](#) the first [part](#).
2. Press **Ctrl**.
3. [Select](#) the rest of [parts](#) without releasing **Ctrl**.

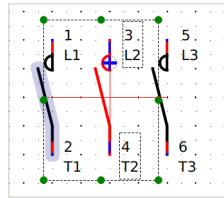

Figure: QElectroTech schema

**Select multiple objects by selecting area**

QElectroTech allows selecting all parts from a defined area using the mouse.

1. Left click on the initial point from the rectangular area to be selected and displace the mouse without releasing the button.

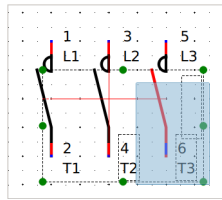

Figure: QElectroTech selecting on workspace

**Select all Parts**

QElectroTech allows selecting all parts from the workspace, all parts from the opened element, at the same time. All parts can be selected from menu bar, workspace or using the corresponding keyboard shortcut.

**Select all parts from menu bar**

1. Select **Edit > Select all** menu item to select all parts from the opened element.

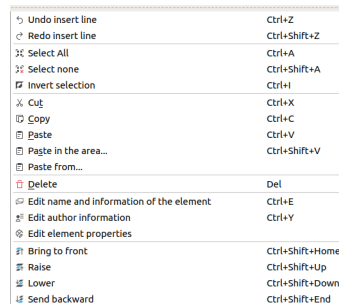

Figure: QElectroTech Edit menu

**Select all parts from workspace**

As many other CAD tools, QElectroTech allows selecting all parts from the workspace using the mouse.

1. Left click on the initial point from the rectangular area to be selected and displace the mouse without releasing the button.

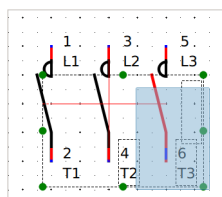

Figure: QElectroTech element editor selecting on workspace

### Select all objects using keyboard shortcut

QElectroTech allows using keyboard shortcut to increase the working efficiency.

1. Press `Ctrl + a` to select all **parts** from the opened **element**.

#### Seealso

For more information about QElectroTech keyboard shortcut, refer to [menu bar](#) section.

### Select none

To be sure that any **part** is selected before any action, QElectroTech provides the option to unselect all **parts** from the **workspace**. This option is useful for avoiding undesired changes.

Unselecting all **parts** can be done from [menu bar](#) or using the corresponding keyboard shortcut.

### Select none from menu bar

1. Select **Edit > Select none** to unselect all selected **parts**.

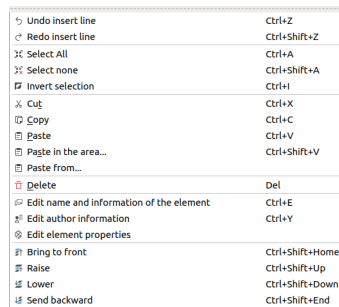

Figure: QElectroTech element editor Edit menu

### Select none using keyboard shortcut

QElectroTech allows using keyboard shortcut to increase the working efficiency.

1. Press `Ctrl + Shift + a` to unselect all selected **parts**.

#### Seealso

For more information about QElectroTech keyboard shortcut, refer to [menu bar](#) section.

### Invert the selection

Some times is easier to select the **parts** from the **workspace** which are not interested for the desired action than the **parts** which should be selected. For this reason, QElectroTech provides the option to invert the selection.

Inverting the selection can be done from [Menu bar](#) or using the corresponding keyboard shortcut.

### Invert selection from menu bar

1. Select the **part/s** from the opened **element** which are not interested for the desired action.
2. Select **Edit > Invert selection** to invert the selection.

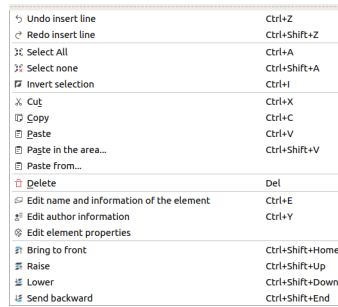

Figure: QElectroTech Edit menu

### Invert selection using keyboard shortcut

QElectroTech allows using keyboard shortcut to increase the working efficiency.

1. Select the **part/s** from the opened **element** which are not interested for the desired action.
2. Press `Ctrl + i` to invert the selection.

Seealso

For more information about QElectroTech keyboard shortcut, refer to [menu bar](#) section.

### Cut part

QElectroTech element editor allows cutting the different possible type of **parts** to paste them later on at different place from the element editor workspace.

#### Note

Multiples **parts** can be cut at the same time, pressing `Ctrl` is necessary to select more than one **part**.

Cutting **parts** can be done from [menu bar](#), by right click on the **part** and from the corresponding keyboard shortcut.

### Cut part from menu bar

1. Select the **part** which should be cut.
2. Select **Edit > Cut** menu item to cut the **part**.

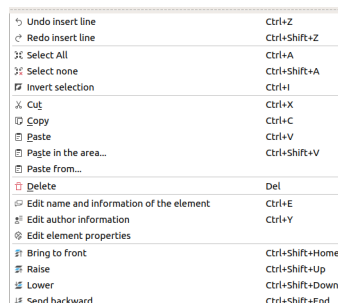

Figure: QElectroTech Edit menu

### Cut part by right click

1. Right click on the **part** which should be cut.

2. Select the option **Cut** to cut the **part**.

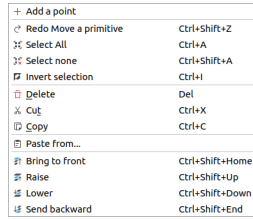

Figure: QElectroTech right click PopUP window

### Cut part using keyboard shortcut

QElectroTech allows using keyboard shortcut to increase the working efficiency.

1. Select the **part** which should be cut.
2. Press **Ctrl + x** to cut the **part**.

#### Seealso

For more information about QElectroTech keyboard shortcut, refer to [menu bar](#) section.

### Copy part

QElectroTech element editor allows copying the different possible type of **parts** to paste them later on at different place from the element editor workspace.

#### Note

Multiples **parts** can be copied at the same time, pressing **Ctrl** is necessary to select more than one **part**.

Copying parts can be done from [menu bar](#), by right click on the **part** and using the corresponding keyboard shortcut.

### Copy part from menu bar

1. Select the **part** which should be copied.
2. Select **Edit > Copy** menu item to copy the **part**.

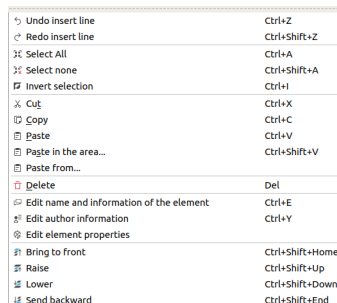

Figure: QElectroTech element editor Edit menu

### Copy part by right click

1. Right click on the **part** which should be copied.
2. Select the option **Copy** to copy the **part**.

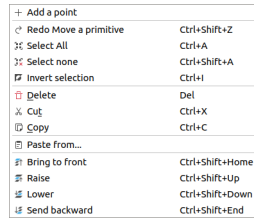

Figure: QElectroTech right click PopUP window

### Copy part using keyboard shortcut

QElectroTech allows using keyboard shortcut to increase the working efficiency.

1. Select the **part** which should be copied.
2. Press **Ctrl + c** to copy the **part**.

Seealso

For more information about QElectroTech keyboard shortcut, refer to [menu bar](#) section.

### Paste part

QElectroTech element editor allows pasting the different possible **type of parts** which have already been copied or cut from the **drawing area**.

#### Note

Multiples **parts** can be pasted at the same time, check [copy part](#) or [cut part](#) section to check how multiples **parts** can be copied or cut.

Pasting **parts** can be done from [menu bar](#), by right click on the **drawing area** and using the corresponding keyboard shortcut.

### Paste part from menu bar

1. Select **Edit > Paste** menu item to paste the **part** copied or cut previously from **drawing area**.

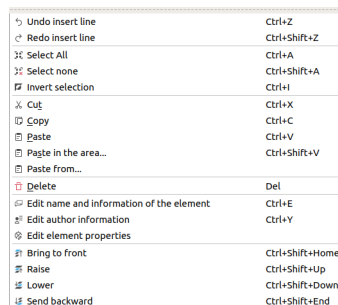

Figure: QElectroTech element editor Edit menu

### Paste part by right click

1. Right click somewhere from **drawing area**.
2. Select the option **Paste** to paste the **part** copied or cut previously.





Figure: QElectroTech right click PopUP window

### Paste part using keyboard shortcut

QElectroTech allows using keyboard shortcut to increase the working efficiency.

1. Press `Ctrl + v` to paste the **part** copied or cut previously from **drawing area**.

#### Seealso

For more information about QElectroTech keyboard shortcut, refer to **menu bar** section.

### Note

The procedure defined at this section only allows pasting the **parts** at the right grid point from the copied or cut **part** position. To be able to choose the place where the **part** has to be pasted, refer to **paste in area** section.

### Paste in area

Paste in area is similar command to paste **part**, the main difference is the place where the **part** can be pasted. At normal paste command QElectroTech pastes the **part** automatically at a predefined position, at paste in area command the user is free to choose the place where the object has to be pasted by using left click on the desired place.

Pasting **parts** in area can be done from **menu bar**, by right click on the **drawing area** and from the corresponding keyboard shortcut.

### Paste part from menu bar

1. Select **Edit > Paste in the area...** menu item to paste the **part** copied or cut previously from **drawing area**.
2. Left click at the **Drawing area** point where the **part** should be pasted.

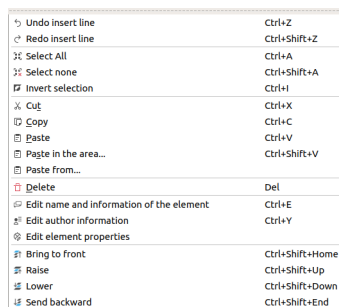

Figure: QElectroTech Edit menu

### Paste part by right click

1. Right click somewhere from **drawing area**.
2. Select the option **Paste in the area...** to paste the **part** copied or cut previously.
3. Left click at the **drawing area** point where the **part** should be pasted.

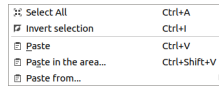

Figure: QElectroTech right click PopUP window

### Paste part using keyboard shortcut

QElectroTech allows using keyboard shortcut to increase the working efficiency.

1. Press `Ctrl + Shift + v` to paste the **part** copied or cut previously from **drawing area**.
2. Left click at the **Drawing area** point where the **part** should be pasted.

#### Seealso

For more information about QElectroTech keyboard shortcut, refer to [menu bar](#) section.

### Paste from

### Delete part

QElectroTech element editor allows deleting **parts** which has been **added** or **pasted** at the **element editor workspace** previously.

Deleting parts can be done from **menu bar**, **toolbar**, by right click on the **part** and using the corresponding keyboard shortcut.

### Delete part from menu bar

1. **Select** the **part** which should be deleted.
2. Select **Edit > Delete** menu item to delete the **part** from **workspace**.

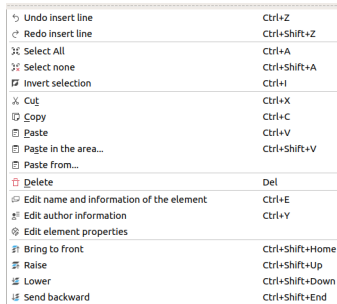



Figure: QElectroTech element editor Edit menu

### Delete part from toolbar

1. **Select** the **part** which should be deleted.
2. Select the icon  from the **toolbar** to delete the **part** from **workspace**.

### Note

If the **toolbar** is not displayed, it can be displayed from **Settings > Display > Tools**

### Delete part by right click

1. Right click on the [part](#) which should be deleted.
2. Select the option **Delete** to delete the [part](#) from [workspace](#).

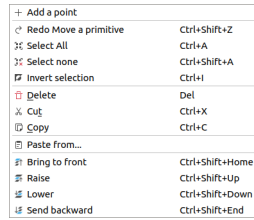

Figure: QElectroTech right click PopUP window

### Delete part using keyboard shortcut

QElectroTech allows using keyboard shortcut to increase the working efficiency.

1. Select the [part](#) which should be deleted.
2. Press `Del` to delete the [part](#) from [workspace](#).

#### Seealso

For more information about QElectroTech keyboard shortcut, refer to [menu bar](#) section.

### Layers in element editor

Overlapping of parts, graphical elements, may occur at the graphical representation of elements. QElectroTech allows defining the representation order from part. Working with layers will be necessary, for example, when a filled part as [rectangle](#) or [ellipse](#) hides a [text](#).

The definition of layer level from each [part](#) can only be done from [menu bar](#).

1. Select the [part](#) which layer level should be defined.
2. Select **Edit** from the main bar and the desired layer action.

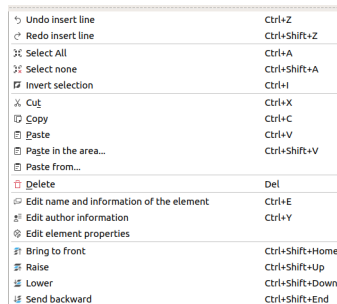

Figure: QElectroTech element editor Edit Menu

Regarding the layer actions allowed by QElectroTech, the following table defines all possibilities.

Icon	Action	Definition	Keyboard shortcut
	Bring to front	Brings the selection (s) to front	Ctrl + Shift + Home
	Raise	Approachs the selection (s)	Ctrl + Shift + Up
	Lower	Moves away the selection (s)	Ctrl + Shift + Down
	Send backwards	Sends in the backwards the selection (s)	Ctrl + Shift + End

### Change element size

QElectroTech provide the feature of changing the size of the graphical symbol from an **element**. This feature is equivalent to the scale feature from CAD tools and graphical vector editors.

### Note

The current version from QElectroTech, version 0.7, does not provide the option of defining the proportion to scale.

To change the size from element symbol:

1. Open the **element** desired using the **element editor**.
2. **Select all element parts** from **workspace**.
3. Press one of the control points from the global element symbol rectangle (green points from the figure).

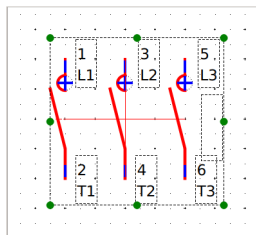

Figure: QElectroTech element editor workspace

4. Move the point without releasing the left button of the mouse.
5. Once the element symbol has been scaled, **save changes** and **close element editor**.

### Element properties definition

#### Define element name

The element name is used to identify the **element** at QElectroTech. The name has no relation with the element file name, they can be completely different. The name file is the name from the file which contains the information from the **element**. The element name is the name which represents the **element** in the different collection.

The element name can be defined in many different languages. Depending on the chosen language at QElectroTech settings, the name is displayed for the user at one language or at another.

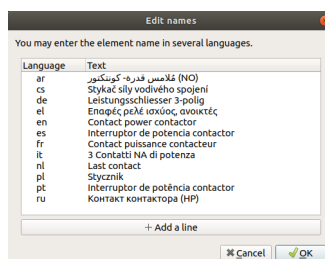

Figure: QElectroTech element name PopUP window

### Note

QElectroTech works according **ISO 639-1** norm. The text language is defined using 2 letters code which should be used at the **Language** column from the cell value table.

**Define element name from menu bar**

1. Select **Edit > Edit name and information of the element** menu item to display the name editor PopUp window.

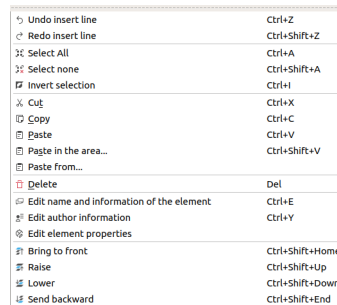



Figure: QElectroTech element editor Edit Menu

2. Press the button **+ Add a line** to introduce a new row at the element name table.
3. Define the 2 letters code language at **Language** column.
4. Define the element name with the defined language at **Text** column.
5. Press the button **OK** to accept and close the name editor PopUp window.

**Define element name from toolbar**

1. Press the icon  from the **toolbar** to display the name editor PopUp window.
2. Press the button **+ Add a line** to introduce a new row at the element name table.
3. Define the 2 letters code language at **Language** column.
4. Define the element name with the defined language at **Text** column.
5. Press the button **OK** to accept and close the name editor PopUp window.

**Note**

If the **toolbar** is not displayed, it can be displayed from **Settings > Display > Element**.

**Define element name using keyboard shortcut**

QElectroTech allows using keyboard shortcut to increase the working efficiency.

1. Press **Ctrl + e** to display the name editor PopUp window.
2. Press the button **+ Add a line** to introduce a new row at the element name table.
3. Define the 2 letters code language at **Language** column.
4. Define the element name with the defined language at **Text** column.
5. Press the button **OK** to accept and close the name editor PopUp window.

**Seealso**

For more information about QElectroTech keyboard shortcut, refer to **menu bar** section.

**Define author element information**

**Define author element information from menu bar**

1. Select **Edit > Edit author information** menu item to display the **author information PopUp window**.

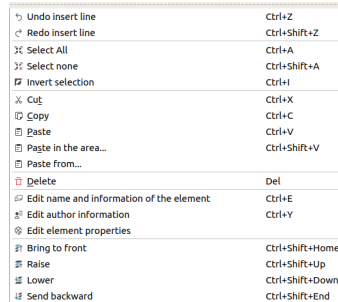

Figure: QElectroTech element editor Edit Menu

2. Introduce the desired information to the text box.
3. Press the button **OK** to accept and close the **author information PopUp window**.

**Define author element information using keyboard shortcut**

QElectroTech allows using keyboard shortcut to increase the working efficiency.

1. Press **Ctrl + y** to display the **author information PopUp window**.
2. Introduce the desired information to the text box.
3. Press the button **OK** to accept and close the **author information PopUp window**.

**Seealso**

For more information about QElectroTech keyboard shortcut, refer to **menu bar** section.

**Edit element properties**

**Edit element properties from menu bar**

1. Select **Edit > Edit element properties** menu item to display the **element properties PopUp window**.

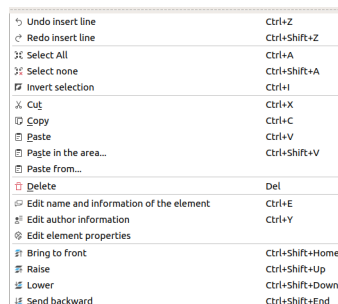

Figure: QElectroTech element editor Edit Menu

2. Select the **element family**, the base type from the **element**, at **Type** tab.

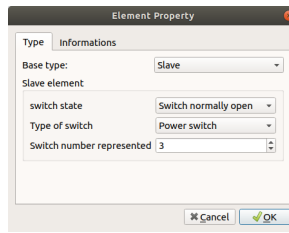

Figure: QElectroTech element properties **Type** tab

For **simple**, **master** or **terminal block** elements:

3. Go to **Informations** tab.

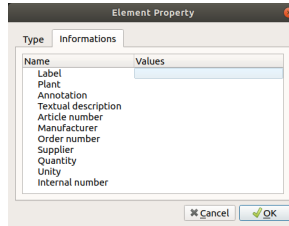



Figure: QElectroTech element properties **Information** tab

4. Fill each predefined field with the desired information.
5. Press the button **OK** to accept and close the element properties PopUp window.

For **slave** or **reference folio** elements:

3. Press the button **OK** to accept and close the element properties PopUp window.

### Edit element properties from toolbar

1. Press the icon  from **toolbar** to display the element properties PopUp window.
2. Follow same procedure defined at the previous section starting from step 2.

### Note

If the **toolbar** is not displayed, it can be displayed from **Settings > Display > Element**.

## Conductor

### What is a conductor?

A **conductor** or conduit represents the means of transmission of information, electrical power, flow power (pressure or flow volume) between source and target.

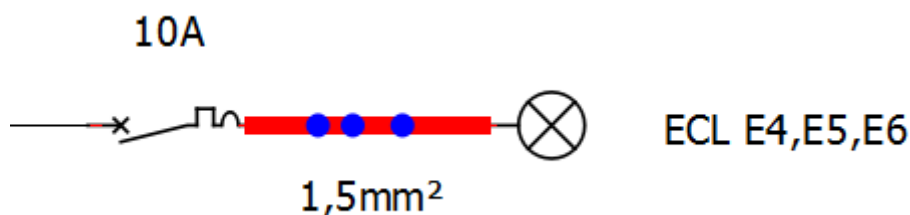

Figure: QElectroTech conductor

In physical systems, T-crosses are used at fluid lines and terminal blocks are used to feed different electrical devices from the same source. QElectroTech also allows multiple connections between source and target.

## Type of conductor

### Single line conductor

The single line conductor is used at [single line diagrams](#). Single line conductors are the simplified notation for representing two and three phase power system drawing using a common [conductor](#). Single line conductors are only used to represent power systems, control systems are normally not represented.

#### Note

At fluid power schemas, the pressure and return line are represented by the same [conductor](#).

QElectroTech does not allow defining any [conductor property](#) at single line conductor. The single line conductor does not have the possibility of text linking.

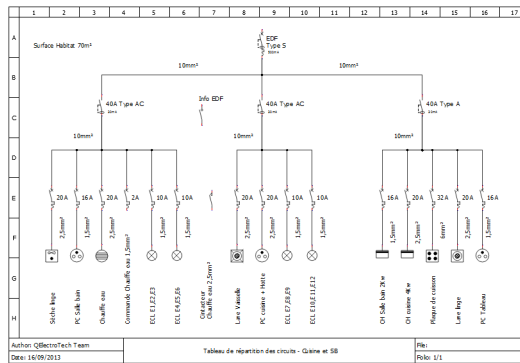
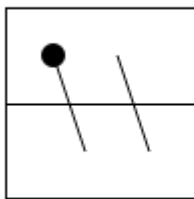

Figure: QElectroTech single line conductors

The most common single line conductors used at [single line diagrams](#) of power electric systems are:

### 2 Phase system



L + N

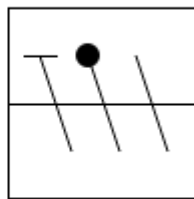

L + N + PE

### 3 Phase system

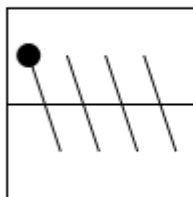

TT system

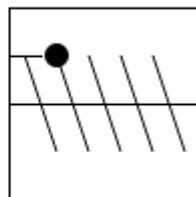

TN - S system

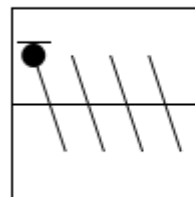

TN - C system (PEN)

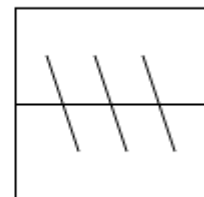

IT system



Figure: Common single line conductors

## Multiline conductor

Multiline conductors are used at [multiline diagrams](#). Multiline conductors are used for the representation of each terminal, line and phase from two and three phase power systems. Multiline conductors are used for the individual representation of all electric and control systems.

### Note

At fluid power schemas, a multiline conductor represents each pressure, return and pilote line.

The main difference of multiline with respect to [single line conductors](#) is the possibility to display text which is linked to the [conductor properties](#).

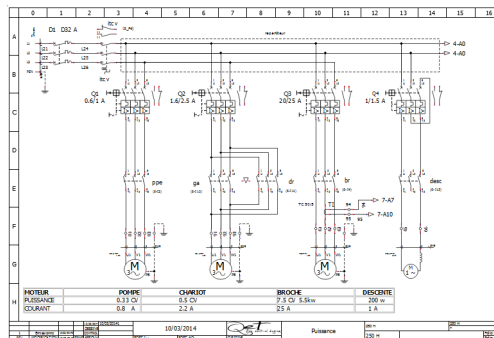

Figure: Multiline conductor

The main features of multiline conductors are:

1. Possibility to define properties (Function and voltage/protocol)
2. Text linked to the conductor which can be displayed and its position is relative to the conductor position.
3. Possibility of displaying variables values at the conductor text (Auto numbering, function or voltage/protocol).
4. Possibility of using the conductor variables at [element dynamic text](#) (Function and voltage/protocol).

## Conductor properties

### Display conductor properties

The conductor properties window can be displayed from [menu bar](#), from [workspace](#) and using the corresponding keyboard shortcut.

### Display conductor properties from menu bar

1. Select the [conductor](#) which [properties](#) should be displayed.
2. Select **Edit > Edit conductor** menu item to display the conductor properties PopUP window.

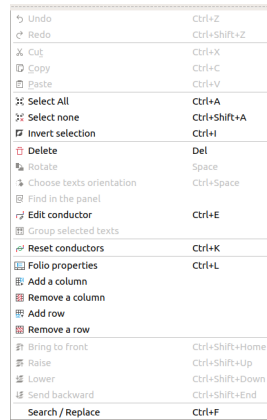

Figure: QElectroTech Edit menu

### Display conductor properties from workspace

1. Right click on the **conductor** which **properties** should be displayed.
2. Select **Edit conductor** option to display the conductor properties PopUP window.

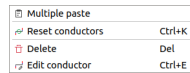

Figure: QElectroTech conductor options

### Display conductor properties using keyboard shortcut

QElectroTech allows using keyboard shortcut to increase the working efficiency.

1. Select the **conductor** which **properties** should be displayed.
2. Press `Ctrl + e` to display the conductor properties PopUP window.

Seealso

For more information about QElectroTech keyboard shortcuts, refer to [menu bar](#) section.

## Conductor type

### Multiline conductor

For **multiline conductors**, QElectroTech allows defining many different parameters from the conductor text. All parameters which can be defined are listed bellow.

1. **Text size**: Size of the test displayed.
2. **Text formula**: To be used if a variable value is desired at the **Text** field during **conductor creation**.
3. **Text**: Text field content to be displayed at **folio**.
4. **Function**: Variable from **conductor**, it is used to define the phase from the **conductor** (L1, L2, L3, N, etc.).
5. **Voltage/Protocol**: Variable from the **conductor**, it is used to define the voltage (0v,230V,400V, 6kV, etc.) or the network protocol (IP).
6. Positioning and orientation from the text displayed at **folio**, vertical and horizontal **conductor**.

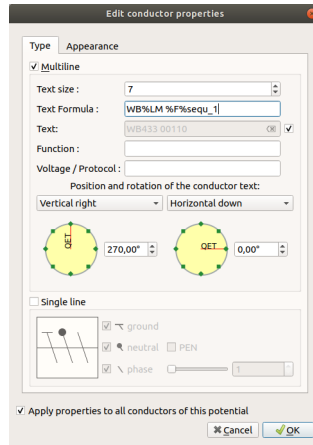

Figure: Multiline conductor properties

## Note

Display the **conductor TAG (code)** at **multiline diagrams** is usual for an easy manage of the manufacturing, erection, commissioning and maintenance phase of the product.

QElectroTech allows an automatic conductor number definition for the text using the variable `%autonum` at the **Text formula** field. This field has to be defined at **Folio properties** before starting the **conductor creation**.

## Single line conductor

For **single line conductors**, the **conductors** are represented without any text information. Only the type of power system should be defined to have the correct symbol representation.

QElectroTech allows the following options for **single line conductors**:

1. System with or without **Ground**
2. System with or without **Neutral**
3. **PEN** system, system where the **Neutral** and the **Ground** are the same conductor.
4. Systems with one, two or three phases

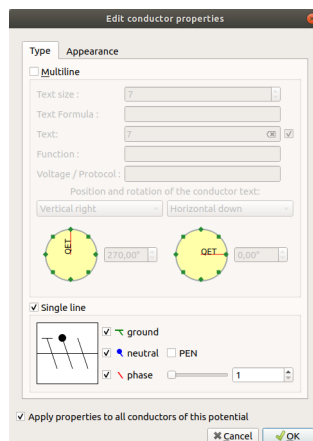

Figure: Single line conductor properties

## Conductor appearance

The color, type and width from the line of the schema that represents the conductor can be defined. A line can have a main color and, if desired, a secondary color.

**Note**

The secondary line is used when a dashes line with double color is desired.



*Figure: Conductor with red secondary color*

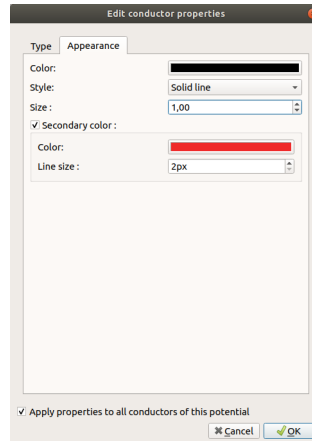

*Figure: Multiline conductor appearance*

- The different types of lines are: **Solid**, **Dashed** and **Dots and dashes**.
- The possible colors are defined by the [RGB scale range](#).
- The possible line thicknesses are between 0.4 and 10 mm (0.4, 0.6, 0.8, 1.0, 1.2, 1.4, 1.6, ... , 10).

**Note**

QElectroTech provides the option to pre-define the appearance of conductor before starting to draw conductors at the folio. This feature increases the working efficiency and avoids defining the appearance of conductors after their creation.

For more information about appearance pre-definition, refer to [folio properties](#) section.

**Conductor numbering**

QElectroTech allows an automatic codification of [conductors](#). This feature is very useful for the creation of [reports](#), [conductor list](#), and for the identification of [conductors](#) at the physical systems and [schemas](#).

QElectroTech allows the definition of multiple auto numbering patterns. It also provides many flexibility on the creation of auto numbering patterns using text, variables and sequential numbers.

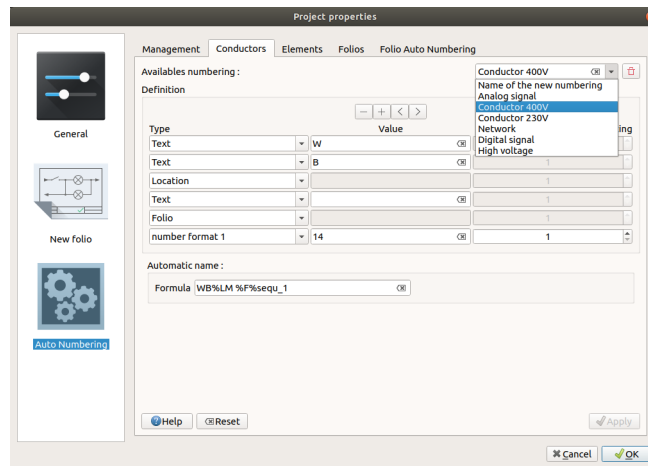

Figure: QElectroTech conductor auto numbering

## Example

Using the content from the image above:

/	X	XX	XXX	N
---	---	----	-----	---

**W:** Code defined by [IEC 81346](#) norm.

- **W:** Guiding or transporting from one place to another.

**X:** Alphanumeric code corresponding to the following coding:

- H: High voltage
- B: 400 V AC
- C: 230 V AC
- D: Digital signal
- A: Analog signal
- @: Network

**XX:** Installation or functional unit to which the cable belongs ([schema](#) where the cable can be found).

- 001: Incoming plant
- 002: Global auxiliary power
- 003: Distribution Network
- 004: installation 1
- 005: installation 2
- ...
- 999: ...

**XXX:** Folio where the cable is represented.

**N:** Cable number.

### See also

For more information about how to define auto numbering patterns, refer to [project auto numbering properties](#) section.

For more information about how to manage the codification of conductors, refer to [create conductor](#) section.

## Schema

### *What is a schema?*

### *Working with elements*

### *Add element*

To add an [element](#) to the [workspace](#):

1. Select [auto numbering pattern](#) at the [Auto numbering selection panel](#).

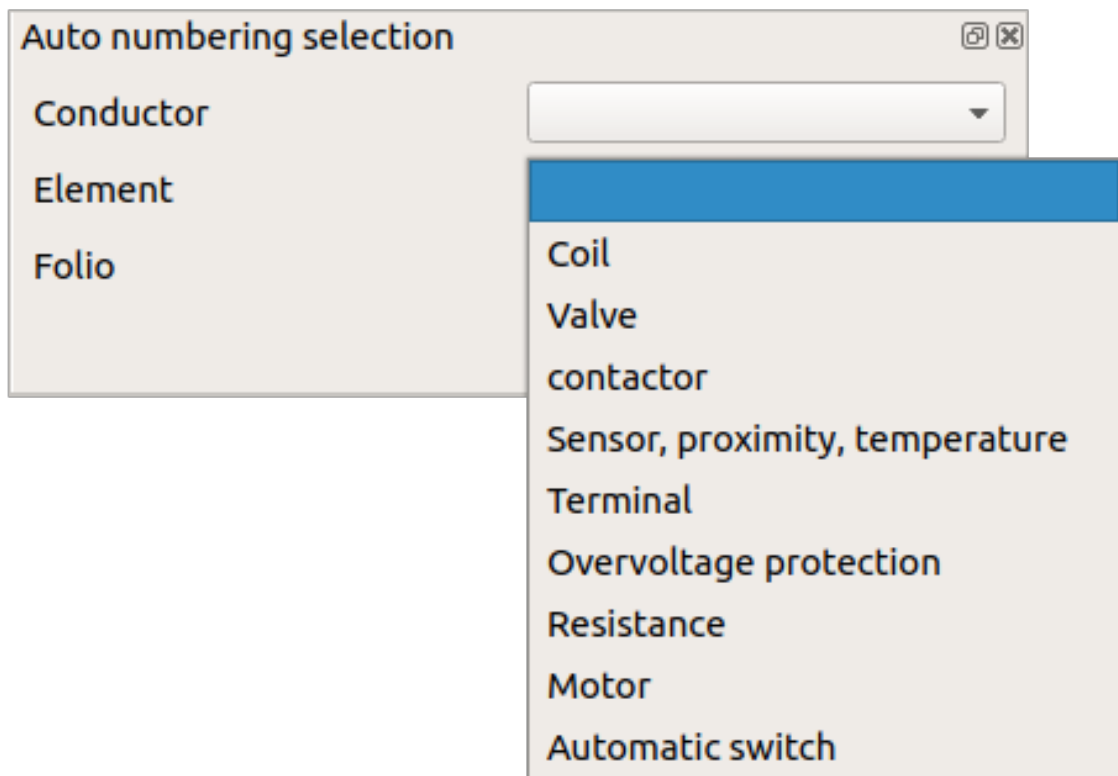

Figure: QElectroTech Auto numbering selection panel

### **Note**

If the [Auto numbering selection panel](#) is not displayed, it can be displayed from **Settings > Display > Auto numbering selection**.

2. Search the [element](#) at the [collection panel](#).
3. Left Click on the desired [element](#). Without releasing move the mouse to the [workspace](#) area, once the mouse is at the [workspace](#) it can be released.
4. Search for the desired element position and left click on the place to add the [element](#), multiples [elements](#) can be added with multiple clicks at different places.
5. Press `esc` to finish the adding action.

## Note

Select **Settings > Display > Collections** menu item to display the collections panel.

## Edit element

To edit an [element](#):

1. Display element properties at [selection properties panel](#).
2. Go to [general properties](#) tab and click on the button **Edit element** to display [element editor](#).

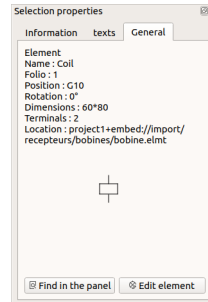

Figure: QElectroTech general element properties

## Note

If the [selection properties panel](#) is not displayed, it can be displayed from **Settings > display > Selection properties**.

Seealso

For more information about how to edit elements, refer to [element editor](#) section.

## Working with cross reference

### Bind slave item

It can happen that one device should be represented in the [project](#) using different [elements](#), power and control subsystem and auxiliary subsystems. All these [elements](#) should be considered as one device. QElectroTech works with [master](#) and [slave](#) elements which are linked using [cross references](#) to represent the device.

A [slave element](#) can be linked to a [master element](#) with the following steps:

1. Select the [master element](#) which should be linked from the [project collection](#) or from the [workspace](#).
2. Right click on the selected [element](#) and choose the option **Edit the element**.

✂ Cut	Ctrl+X
📄 Copy	Ctrl+C
📄 Multiple paste	
🗑 Delete	Del
🔄 Rotate	Space
🔍 Find in the panel	
🔗 Edit the element	Ctrl+E
📄 Bring to front	Ctrl+Shift+Home
📄 Raise	Ctrl+Shift+Up
📄 Lower	Ctrl+Shift+Down
📄 Send backward	Ctrl+Shift+End

Figure: QElectroTech element options

3. Display the **Cross-reference (Master)** tab from the element editor PopUP window.

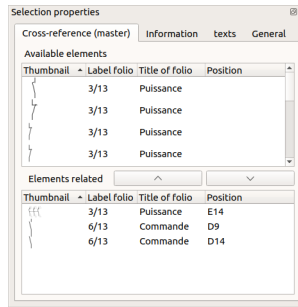

Figure: QElectroTech cross reference tab element properties

4. Search and select the desired **slave element** from the **Available elements** table.
5. Press **Bind item** to link the **slave element** to the **master element**.
6. Press **Apply** to accept and save the changes.

### Note

At the available elements table, the **slave element** can also be linked by right click on the **element** and selecting the option **Link the item**.

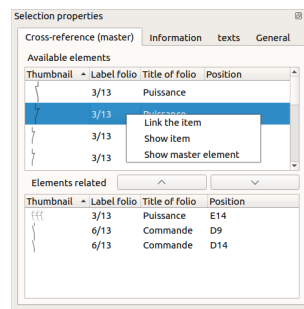

Figure: QElectroTech cross reference tab element properties

### Bind master item

It can happen that one device should be represented in the **project** using different **elements**, power and control subsystem and auxiliary subsystems. All these **elements** should be considered as one device. QElectroTech works with **master** and **slave** elements which are linked using **cross references** to represent the device.

A **master element** can be linked to a **slave element** with the following steps:

1. Select the **Slave element** which should be linked from the **project collection** or from the **workspace**.
2. Right click on the selected **element** and choose the option **Edit the element**.

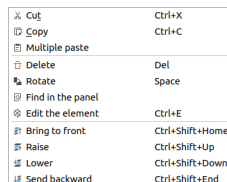

Figure: QElectroTech element options

3. Display the **Cross-reference (Slave)** tab from the element editor PopUP window



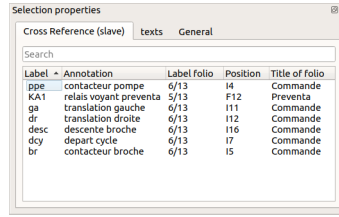

Figure: QElectroTech cross reference tab element properties

4. Search and select the desired **master element** from the available master elements table.
5. Right click on the **master element** and select the option **Link the item** to link the **master element** to the **slave element**.

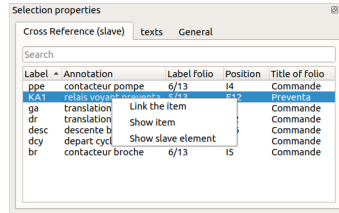

Figure: QElectroTech cross reference tab element properties

6. Press **Apply** to accept and save the changes.

### Untie slave item

Some times is necessary to delete previous work, QElectroTech allows breaking/deleting links between elements (cross references).

A **Slave element** can be unlinked from a **master element** as follow:

1. Select the **master element** which should be unlinked from the **project collection** or from the **workspace**.
2. Right click on the selected **element** and choose the option **Edit the element**.

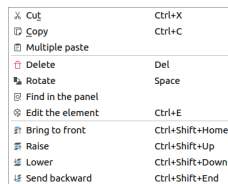

Figure: QElectroTech element options

3. Display the **Cross-reference (Master)** tab from the element editor PopUP window

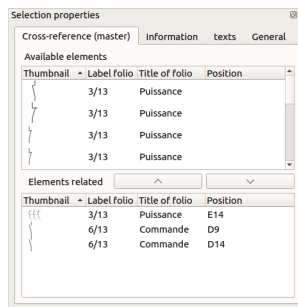



Figure: QElectroTech cross reference tab element properties

4. Search and select the desired **slave element** from the **Element related** table.
5. Press the **Untie item** button  to unlink the **slave element** from the **master element**.
6. Press **Apply** to accept and save the changes.

## Note

The **slave element** can also be unlinked by right click on the **element** and selecting the option **Unlink the item**.

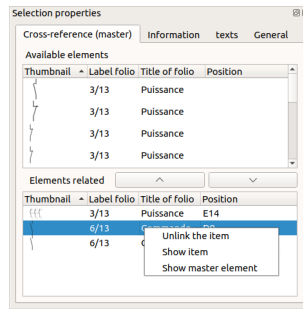

Figure: QElectroTech cross reference tab element properties

## Untie master item

Some times is necessary to delete previous work, QElectroTech allows breaking/deleting links between elements (cross references).

A **master element** can be unlinked from a **slave element** as follow:

1. Select the **Slave element** which should be unlinked from the **project collection** or from the **workspace**.
2. Right click on the selected **element** and choose the option **Edit the element**.

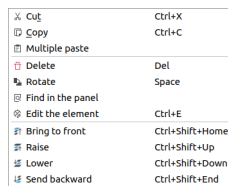

Figure: QElectroTech element options

3. Display the **Cross-reference (Slave)** tab from the element editor PopUP window

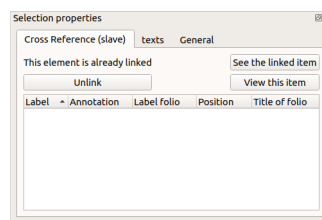

Figure: QElectroTech cross reference tab element properties

4. Press **Unlink** to delete the **cross reference** with the **master element**.
5. Press **Apply** to accept and save the changes.

## Show linked item

On of the advantages of working with **cross references** on E-CAE tools like QElectroTech is the possibility to find the linked **elements** automatically. QElectroTech allows finding a linked **element** easily.

If the **master** and **slave/s** element/s are at the same **folio**, only by placing the mouse at one **element**, the other/s will be remarked in blue. The linked **element/s** can also be found from the **element properties**.

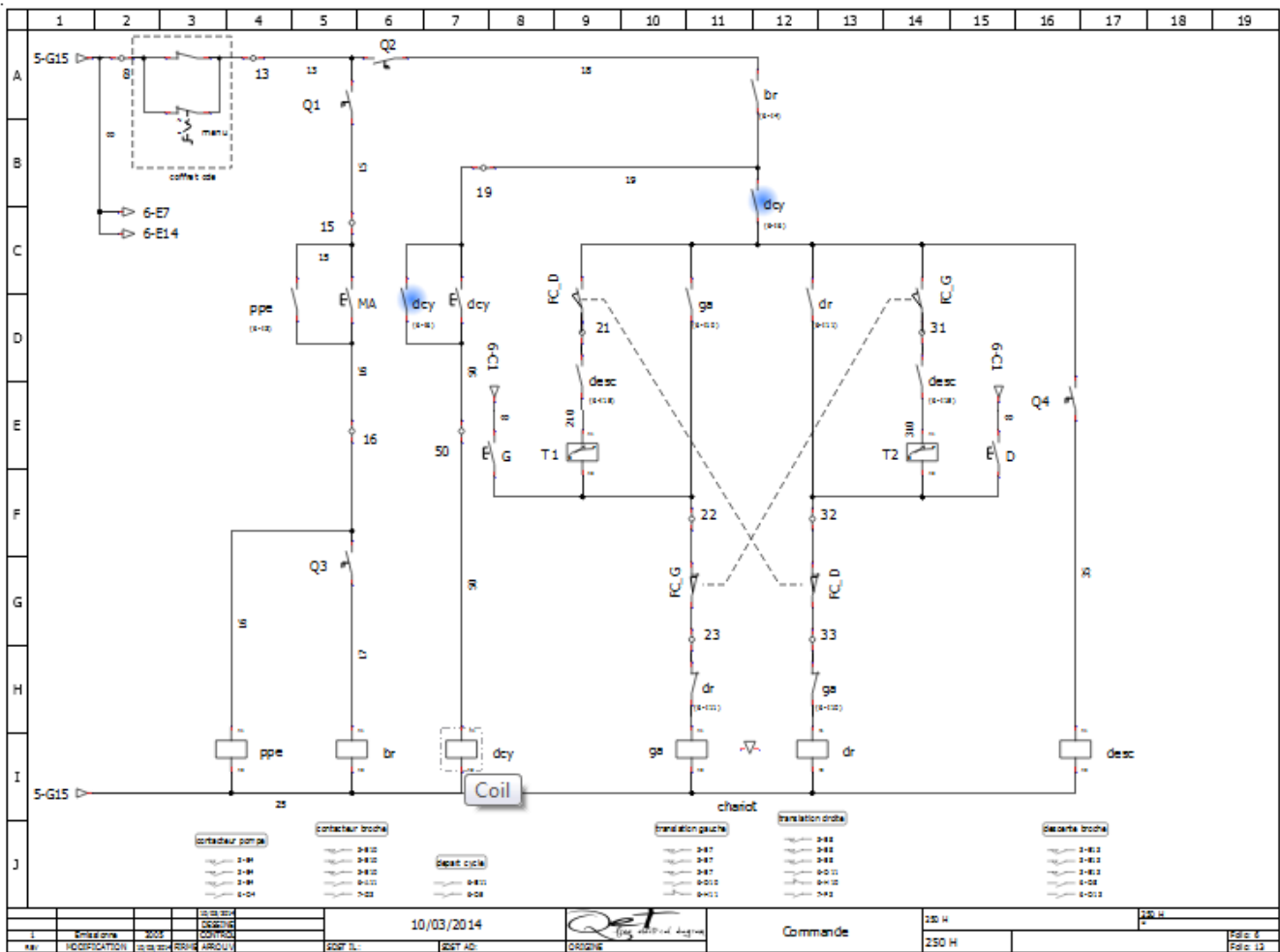

Figure: QElectroTech elements cross reference

At the case that the elements are at different folios, the linked element/s can only be found from the element properties.

**Show slave linked item**

1. Select the slave element which should be linked from the project collection or from the workspace.
2. Right click on the element selected and choose the option **Edit the element**.

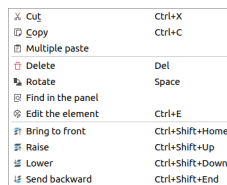

Figure: QElectroTech element options

3. Display the **Cross-reference (Slave)** tab from the element editor PopUP window

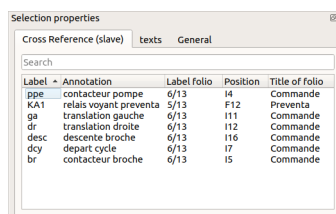

Figure: QElectroTech cross reference tab element properties

4. Search and select the desired **slave element** from the **Element related** table.
5. Right click on the **slave element** and select the option **Show item** to find and display the **master element**.

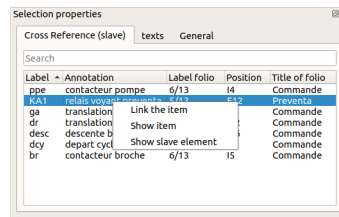

Figure: QElectroTech cross reference tab element properties

### Show Master linked item

1. Select the **slave element** from the **project collection** or from the **workspace**.
2. Right click on the selected element and choose the option **Edit the element**.

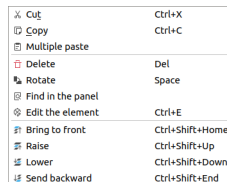

Figure: QElectroTech element options

3. Display the **Cross-reference (Slave)** tab from the element editor PopUP window

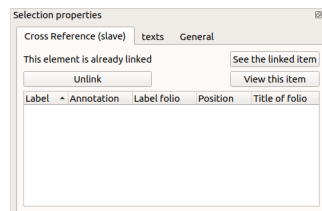

Figure: QElectroTech cross reference tab element properties

4. Press **See the linked item** to find and display the **master element**.

## Working with conductors

### Create conductor

#### Manual conductor creation

To create a **conductor** manually:

1. Select **auto numbering pattern** at the **Auto numbering selection panel**.

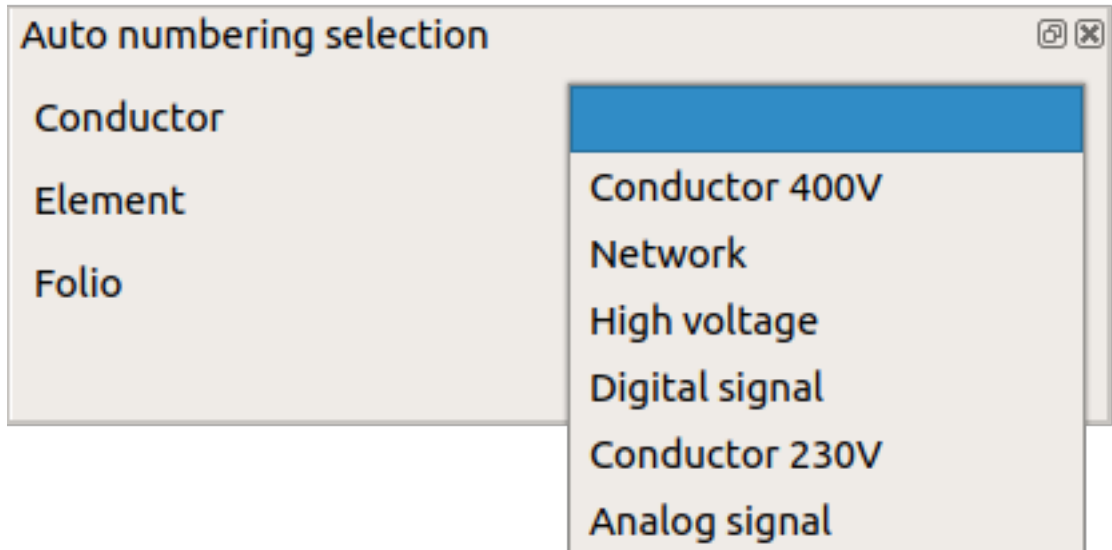

Figure: QElectroTech Auto numbering selection panel

**Note**

If the [Auto numbering selection panel](#) is not displayed, it can be displayed from **Settings > Display > Auto numbering selection**.

2. Click on the initial [terminal](#) from the [conductor](#).
3. Without releasing, move the mouse up to the end [terminal](#) of the [conductor](#).
4. Once the end [terminal](#) is automatically identified by QElectroTech, release the mouse to create the [conductor](#).

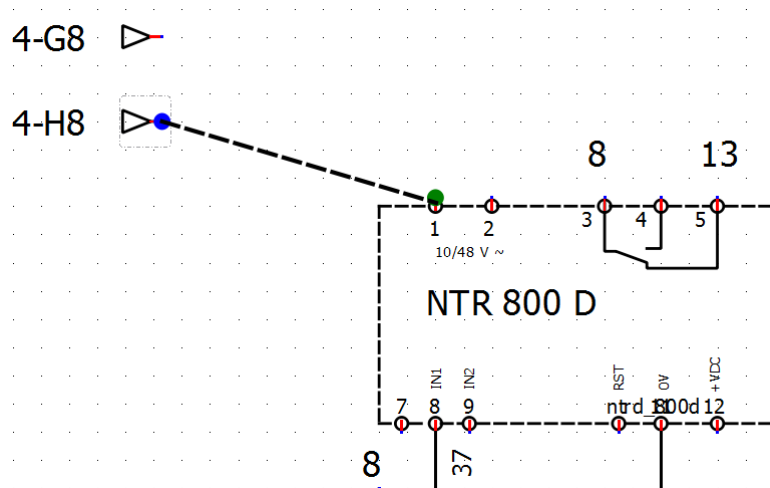

Figure: QElectroTech manual conductor creation

**Automatic conductor creation**

To increase the working efficiency, QElectroTech can create [conductors](#) automatically when an [element](#) is added to the [workspace](#).

To create a [conductor](#) automatically:

1. Select [auto numbering pattern](#) at the [Auto numbering selection panel](#).

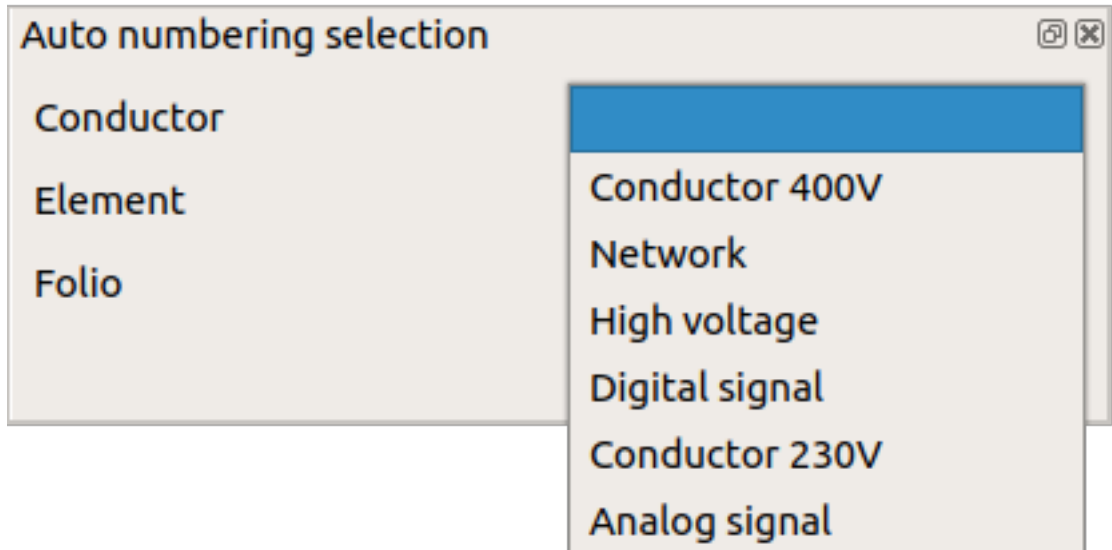



Figure: QElectroTech Auto numbering selection panel

**Note**

If the [Auto numbering selection panel](#) is not displayed, it can be displayed from **Settings > Display > Auto numbering selection**.

2. Select the icon  from [toolbar](#), if it is not selected.
3. [Add element](#) to [workspace](#) taking care of the [element](#) position, the initial [terminal](#) and the end [terminal](#) have to be at the same vertical or horizontal line.

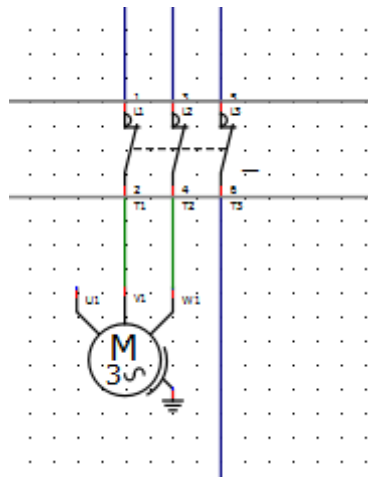

Figure: QElectroTech automatic conductor creation

**Note**

If the [toolbar](#) is not displayed, it can be displayed from **Settings > Display > Tools**.

## Warning

At the case that the initial and end **terminal** are different potentials, QElectroTech considers two **terminals** from the same **element** as different potentials, QElectroTech will inform by a warning PopUP window. Nevertheless, QElectroTech will create the **conductor**

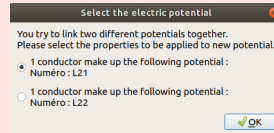

Figure: QElectroTech different potentials warning

## Modify conductor

QElectrotech draws by default a **conductor** minimizing the horizontal and vertical lines. Changing the route of the **conductor** for a clear understanding of the **schema** is some times necessary. QElectroTech allows modifying the route.

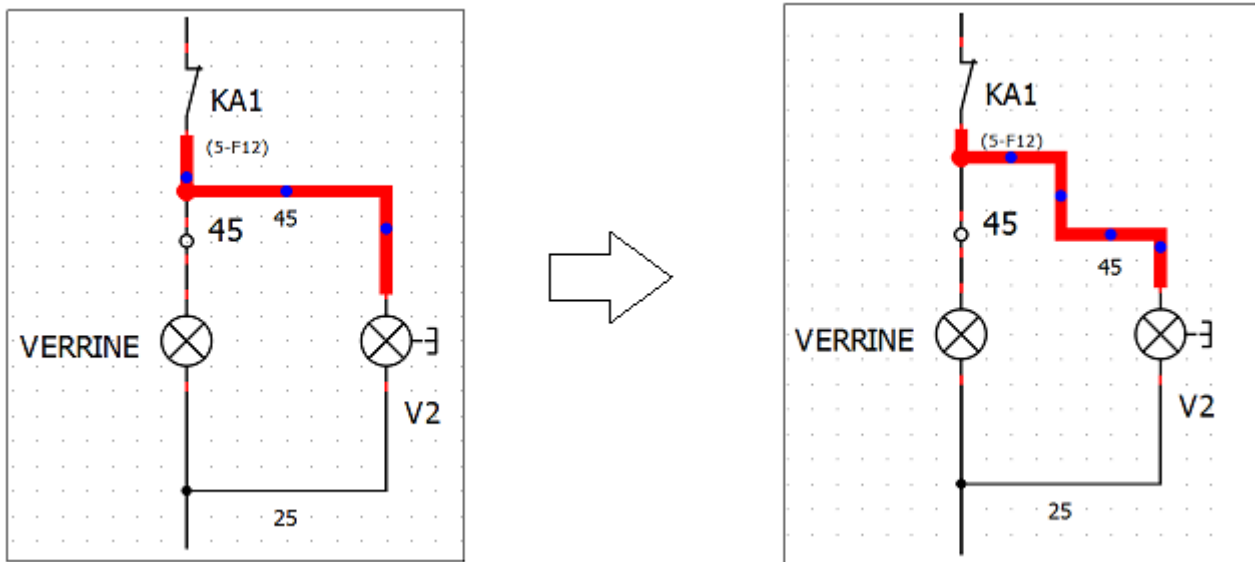

Figure: QElectroTech modify conductor

To modify the route of a **conductor**:

1. **Select the conductor** which route should be modified.
2. Press on a control point, blue points, from the **conductor** selected.
3. Without releasing the control point, displace the control point horizontally or vertically until desired position.

## Reset conductors

QElectroTech provides the possibility to return to the default route once a conductor route has been modify.

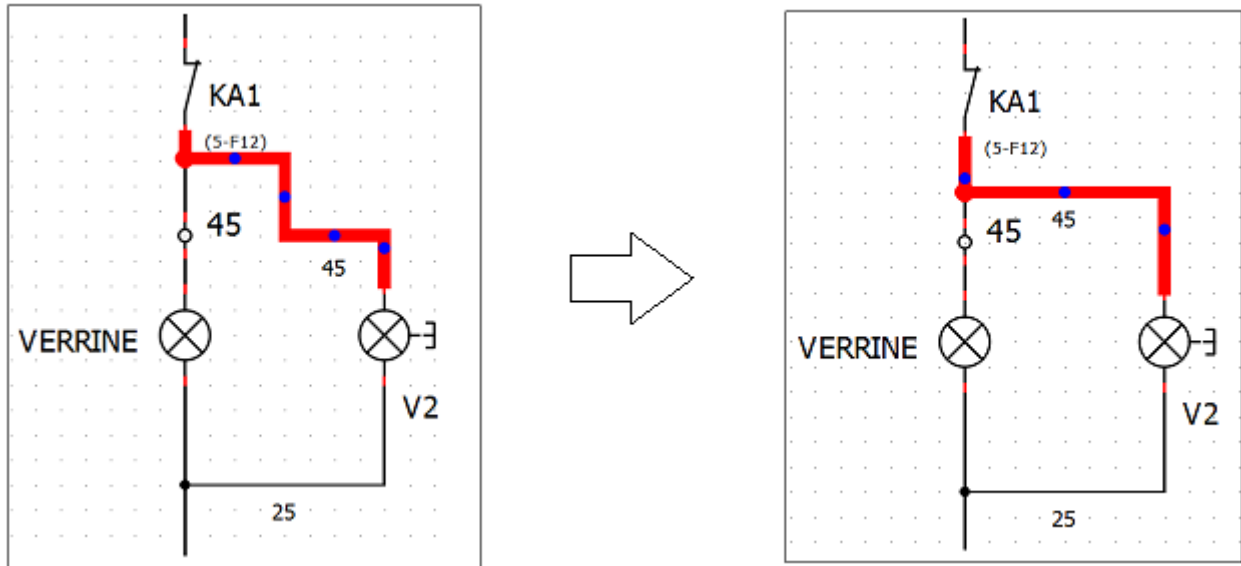

Figure: QElectroTech reset conductor

QElectroTech allows resetting the route of a conductor from menu bar, toolbar, workspace or using keyboard shortcut.

### Reset conductor from menu bar

1. Select the conductor which route should be reseted.
2. Select **Edit > Reset conductors** menu item to reset the conductor route.

↶ Undo	Ctrl+Z
↷ Redo	Ctrl+Shift+Z
X Cut	Ctrl+X
📄 Copy	Ctrl+C
📄 Paste	Ctrl+V
⌘ Select All	Ctrl+A
⌘ Select none	Ctrl+Shift+A
🔄 Invert selection	Ctrl+I
🗑 Delete	Del
🔄 Rotate	Space
⏴ Choose texts orientation	Ctrl+Space
🔍 Find in the panel	
🔧 Edit conductor	Ctrl+E
📄 Group selected texts	
🔄 Reset conductors	Ctrl+K
📄 Follow properties	Ctrl+L
➡ Add a column	
⬅ Remove a column	
⬆ Add row	
⬆ Remove a row	
📄 Bring to front	Ctrl+Shift+Home
📄 Raise	Ctrl+Shift+Up
📄 Lower	Ctrl+Shift+Down
📄 Send backward	Ctrl+Shift+End
🔍 Search / Replace	Ctrl+F

Figure: QElectroTech edit menu

### Reset conductor from toolbar

1. Select the conductor which route should be reseted.
2. Select the icon  from toolbar to reset the conductor route.

### Note

If the toolbar is not displayed, it can be displayed from **Settings > Display > Tools**.

### Reset conductor from workspace



1. Right click on the conductor which route should be reseted.
2. Select the option **Reset conductors** to reset the conductor route.



Figure: QElectroTech conductor options

### Reset conductor using keyboard shortcut

QElectroTech allows using keyboard shortcut to increase the working efficiency.

1. Select the conductor which route should be reseted.
2. Press `Ctrl + k` to reset the conductor route.

Seealso

For more information about QElectroTech keyboard shortcut, refer to [menu bar](#) section.

### Define text at conductor

QElectroTech allows defining and displaying information text at each conductor.

#### Note

Only [multiline conductors](#) allow text definition.

To define the conductor text:

1. Select the conductor which should be edited.
2. Display conductor properties PopUp window.
3. Go to multiline section from **Type** tab.

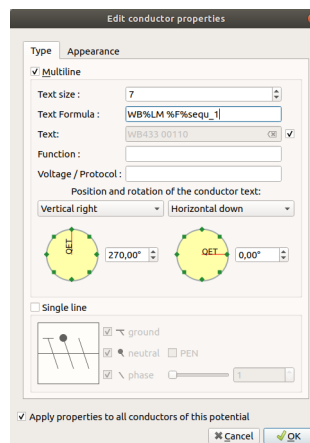

Figure: QElectroTech multiline conductor text section

4. Choose the desired parametes for text positioning, text content or formula, text size, etc.
5. Click the check button **Apply properties to all conductor of this potential** if the changes should be applied for all conductor with common initial or end terminal.
6. Press **OK** button to save and apply the property changes.

Seealso

For more information about multiline properties, refer to [conductor type properties](#) section.

For more information about automatic text definition during conductor creation, refer to [project folio properties](#) section.

## Change appearance conductor

QElectroTech allows changing the [conductors appearance](#), the line style and color can be defined for each [conductor](#).

To change the conductor appearance:

1. Select the [conductor](#) which should be edited.
2. Display [conductor properties](#) PopUp window.
3. Go to **Appearance** tab.

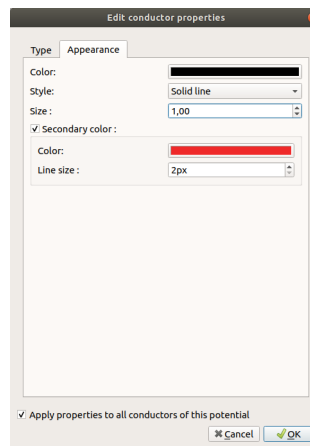

Figure: QElectroTech conductor appearance PopUP window

4. Choose the desired parameters for main color and secondary color if necessary.
5. Click the check button **Apply properties to all conductor of this potential** if the changes should be applied for all [conductor](#) with common initial or end ``terminal`_`. 5. Click or unclick the option **Apply properties to all conductors of this potential**. 6. Press **OK** button to save and apply the property changes.

Seealso

For more information about conductor appearance, refer to [conductor appearance](#) section.

## Working with text field

### Insert text field

#### Note

To draw more easily, the folio grid can be displayed from **Display > Display the grid** or from [toolbar](#) icon .

The text field can only be added to the [workspace](#) by [toolbar](#).

1. Select the icon  from [toolbar](#).

2. Click on the [workspace](#) place point where the [text field](#) should be placed.
3. Write the desired text.
4. Click anywhere from the [workspace](#) to top the edition process and save the text content.

### Note

If the [toolbar](#) is not displayed, it can be displayed from **Settings > Display > Add**.

### Edit text field

#### Edit text field from menu bar

1. Select the [text field](#) which should be edited.
2. Select **Edit > Edit the selected object** menu item to display the [text editor PopUP window](#).

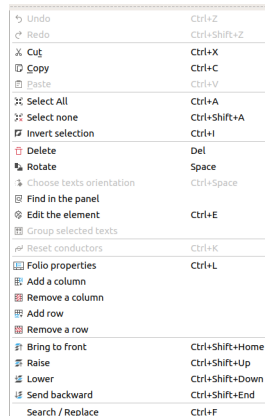

Figure: QElectroTech edit menu

#### Edit text field by right click

1. Right click on the [text field](#) which should be edited.
2. Select the option **Edit the text field** to display the [text editor PopUP window](#).

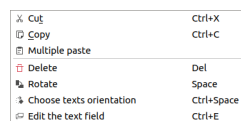

Figure: QElectroTech text field options

#### Edit text field using keyboard shortcut

QElectroTech allows using keyboard shortcut to increase the working efficiency.

1. Select the [text field](#) which should be edited.
2. Press **Ctrl + e** to display the [text editor PopUP window](#).

### Seealso

For more information about QElectroTech keyboard shortcuts, refer to [menu bar](#) section.

## Text editor

The text editor from QElectroTech allows two different philosophy to introduce text in the [workspace](#):

1. What You See Is What You Get (WYSIWYG)
2. HTML code to create content and define format.

## Rich text tab

The Rich text tab is used when the WYSIWYG philosophy is applied. The different options from the rich text are:

1. Definition of content.
2. Definition of font color.
3. Definition of font size.
4. Definition of additional font options (underlined, bold and italic style, superscript, subscript)

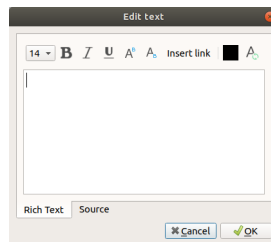

Figure: QElectroTech Text editor rich text tab

## Source tab

The source tab is used when the text content and the format is defined using HTML code. QElectroTech processes internally the HTML code and compiles the result to be shown. The formatting limits are at HTML code.

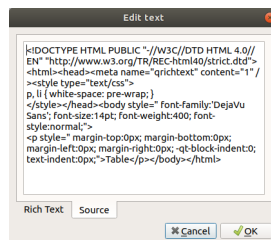

Figure: QElectroTech Text editor source tab

## Move text

A [text field](#) is considered on object more in the [workspace](#). A [text field](#) can be move around the [workspace](#) using the mouse or the keyboard like [elements](#), [basic objects](#) or [pictures](#).

## Move text field by mouse

1. Left click on the [text field](#) which should be moved.
2. Without releasing, move the mouse to the new desired position.

## Move text field by keyboard

1. [Select the text field](#) which should be moved.
2. Press the corresponding arrow (Downwards, Rightward, Leftwards or Upwards) to move the [text field](#) one grid row or column.

## Rotate text

The content from a [text field](#) can be rotated in two different ways:

1. Rotating the [text field](#) as an object.
2. Defining the text orientation inside the [text field](#).

### Rotate the text field

The text field is considered an object by QElectroTech, it can be selected, placed and rotated as [elements](#) and [pictures](#). It can be rotated 90, 180 or 270 degrees.

1. Right click on the [text field](#) which should be rotated.

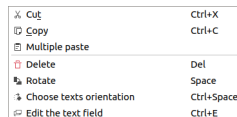

Figure: QElectroTech text field options

2. Select the option **Rotate** to rotate the [text field](#) 90 degrees on the clock direction.

Seealso

For more information about rotating objects at the [workspace](#), refer to [rotate object section](#).

### Define text orientation

Defining the text orientation rotates only the content from the [text field](#). The advantage of choosing the text orientation is the possibility to choose any angle value between -360 and 360 degrees.

1. Right click on the [text field](#) which should be oriented.

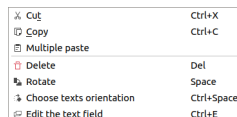

Figure: QElectroTech text field options

2. Select the option **Choose text orientation** to display the text orientation PopUP window.

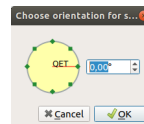

Figure: QElectroTech choose orientation PopUP window

3. Define the angle of orientation from the text.
4. Press **OK** to save the changes and close the text orientation PopUP window.

### Insert URL link

QElectroTech works with text as html code. This property allows the user introducing at the [workspace](#) anything that is possible with HTML code. This section explains how the user can create an URL link for a text.

## Note

The URL link is only activated at the PDF version of the document. The link is not activated at the native QElectroTech format.

At the current released version, version 0.7, QElectroTech allows creating an URL link internally or using external html code generators.

### Insert URL link from QElectroTech text editor

1. Display the [text editor](#) by editing the desired [text field](#).

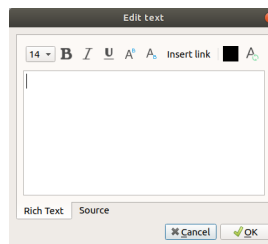

Figure: QElectroTech Text editor rich text tab

2. Press the icon **Insert link** from the Menu bar for displaying the Insert link PopUP window.

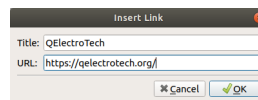

Figure: QElectroTech insert link PopUP window

3. Define the text which should be displayed at the [workspace](#) and the desired URL where the link should redirect.
4. Press the button **OK** to close the Insert link PopUP window and add the link to the text field content.
5. Press the button **OK** to save the text field content and close the [text editor](#).

### Insert URL link using external html code generators

At the case that something special should be included or any propertie should be different, QElectroTech allows creating the html source code using an external code generator and later on introduce the code.

1. Display the [text editor](#) by editing the desired [text field](#).

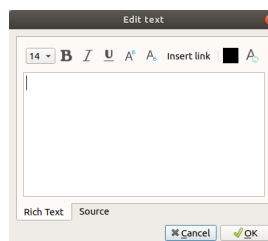

Figure: QElectroTech Text editor rich text tab

2. Select the source Tab.

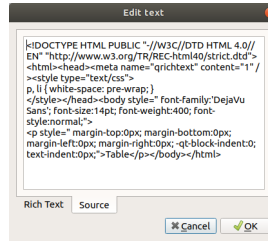

Figure: QElectroTech Text editor source tab

3. Copy the html code from the html code generator.
4. Press the button **OK** to save the text field content and close the **text editor**.

### Note

Many different HTML Table Generator can be found on internet or can be installed at the computer. One internet example is the following:

<https://html-css-js.com/html/generator/>

### Insert table

QElectroTech 0.7 does not have any **tool** or **menu** item which creates tables with the number of rows and columns desired automatically. QElectroTech allows importing HTML text, this is the way to create tables.

1. Select icon **Add textfield**  from the **toolbar**.
2. Click on the area from the **workspace** where the table should be created.
3. Right click on text field and choose **Edit the text field** option.



Figure: QElectroTech text field option

4. Choose the **source** tab from the **text field editor**.

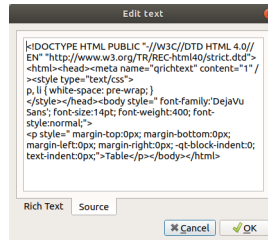

Figure: Source tab text field editor

5. Copy the `html` code generated by the HTML Table Generator.
6. Choose the **Rich Text** tab from the **text field editor**.

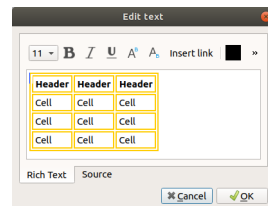

Figure: Rich text tab text field editor

7. Fill the headers and cells with the corresponding information.
8. Press **OK** button and the table will be created at the **workspace**.

### Note

If the **toolbar** is not displayed, it can be displayed from **Settings > Display > Add**.

The table can be **moved** and **rotated** over the folio area like a **text field**, it is a **text field** object.

### Note

Many different HTML Table Generator can be found on internet or can be installed at the computer, an online option is:

[https://www.quackit.com/html/html\\_table\\_generator.cfm](https://www.quackit.com/html/html_table_generator.cfm)

## Basic objects

In addition to working with elements and conductors, QElectroTech also allows drawing primitive 2D geometries (line, rectangle, ellipse and polygon) at the workspace.



## Line

### Create line

#### Note

To draw more easily, the folio grid can be displayed from **Display > Display the grid** or from **toolbar** icon .

A line can only be added to the **workspace** by **toolbar**.

1. Select the icon  from **toolbar** to add a line.
2. Click on the initial point from the line.
3. Click on the end point from the line.

#### Note

If the **toolbar** is not displayed, it can be displayed from **Settings > Display > Add**.

### Line properties

QElectroTech allows customizing the type of line, the thickness from the line and the color of the line.

- The different types of lines are: **normal, dashed, dotted, dots and dashes, dash dot dot** and **custom dash line**.

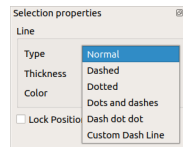

Figure: QElectroTech Color selection PopUP window

- The possible line thiknes are between 0.2 and 50 mm (0.2, 0.4, 0.8, 0.6, 0.8, 1, 1.2, 1.4, ... , 50).
- The possible colors are defined by the **RGB scale range**.

#### Note

The position from the line can be locked to prevent involuntary movement.

- Go to line properties and check the **Lock position** button.

The line properties can be displayed from **menu bar**, by right click on the line, from selection properties panel and using keyboard shortcut.

### Line properties from menu bar

1. Select the line which should be edited.
2. Select **Edit > Edit the selected object** menu item to display the line properties PopUP window.

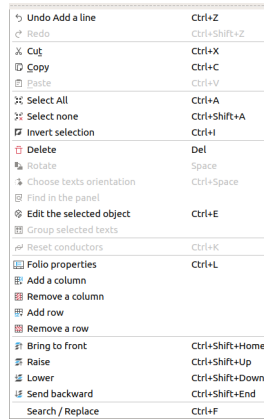

Figure: QElectroTech edit menu

**Line properties by right click**

1. Right click on the line which should be edited.
2. Select the option **Edit the selected object** to display the line properties PopUP window.



Figure: QElectroTech line selection PopUP window

**Line properties from selection properties panel**

1. Select the line which should be edited and the properties from the line will appear at [selection properties panel](#).

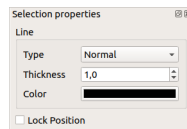

Figure: QElectroTech Line properties panel

**Note**

If the [selection properties panel](#) is not displayed, it can be displayed from **Settings > Display > Selection properties**

**Line properties using keyboard shortcut**

QElectroTech allows using keyboard shortcut to increase the working efficiency.

1. Select the line which should be edited.
2. Press **Ctrl + e** to display the line properties PopUP window.

**Seealso**

For more information about QElectroTech keyboard shortcuts, refer to [menu bar](#) section.

## Rectangle

### Create rectangle

#### Note

To draw more easily, the folio grid can be displayed from **Display > Display the grid** or from **toolbar** icon .

The rectangle can only be added to the **workspace** by **toolbar**.

1. Select the icon  from **toolbar** to add a rectangle.
2. Click on the initial vertex from the rectangle.
3. Click on the end vertex from the rectangle.

#### Note

If the **toolbar** is not displayed, it can be displayed from **Settings > Display > Add**.

### Rectangle properties

The edges and the internal area from the triangle can be costumized at QElectroTech.

- The edges from a rectangle have the same properties as a **line**.
- The type of filling for closed primitive objects (rectangle, ellipse and closed polygon) are: **None**, **Solid line** and some types of grids.

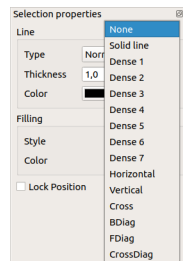

Figure: QElectroTech Color selection PopUP window

- The possible filling colors are defined by the **RGB scale range**.

#### Note

The position from the rectangle can be locked to prevent involuntary movement.

- Go to rectangle properties and check the **Lock position** button.

The rectangle properties can be displayed from **menu bar**, by right click on one rectangle edge, from selection properties panel and using keyboard shortcut.

### Rectangle properties from menu bar

1. Select one of the edges from the rectangle which should be edited.

2. Select **Edit > Edit the selected object** menu item to display the rectangle properties PopUP window.

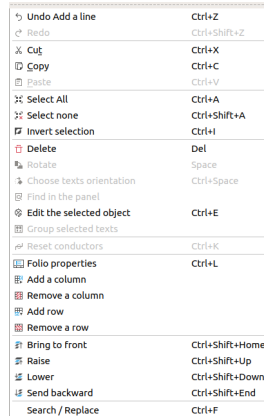

Figure: QElectroTech edit menu

**Rectangle properties by right click**

1. Right click on one of the edges from the rectangle which should be edited.
2. Select the option **Edit the selected object** to display the rectangle properties PopUP window.

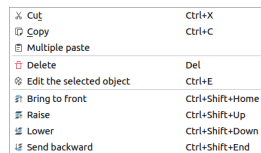

Figure: QElectroTech rectangle selection PopUP window

**Rectangle properties from selection properties panel**

1. Select one of the edges from the rectangle which should be edited and the properties from the rectangle will appear at [selection properties panel](#).

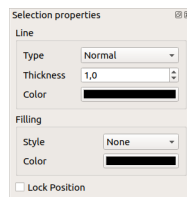

Figure: QElectroTech Rectangle properties panel

**Note**

If the [selection properties panel](#) is not displayed, it can be displayed from **Settings > Display > Selection properties**

**Rectangle properties using keyboard shortcut**

QElectroTech allows using keyboard shortcut to increase the working efficiency.

1. Select one of the edges from the rectangle which should be edited.
2. Press `Ctrl + e` to display the rectangle properties PopUP window.

Seealso

For more information about QElectroTech keyboard shortcuts, refer to [menu bar](#) section.

## Ellipse

### Create ellipse

#### Note

To draw more easily, the folio grid can be displayed from **Display > Display the grid** or from [toolbar](#) icon .

The ellipse can only be added to the [workspace](#) by [toolbar](#).

1. Select the icon  from the [toolbar](#) to add an ellipse.
2. Click on the initial controlling point from the ellipse.
3. Click on the end controlling point from the ellipse.

#### Note

If the [toolbar](#) is not displayed, it can be displayed from **Settings > Display > Add**.

### Ellipse properties

The border line and the internal area from the ellipse can be customized at QElectroTech.

- The border line from a ellipse has the same properties as a [line](#).
- The type of filling for closed primitive objects (rectangle, ellipse and closed polygon) are: **None**, **Solid line** and some types of grids.

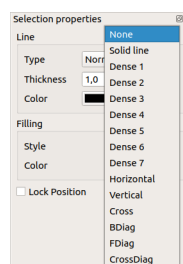

Figure: QElectroTech Color selection PopUP window

- The possible filling colors are defined by the [RGB scale range](#).

#### Note

The position from the ellipse can be locked to prevent involuntary movement.

- Go to ellipse properties and check the **Lock position** button.

The ellipse properties can be displayed from [menu bar](#), by right click on border from the ellipse, from selection properties panel and using keyboard shortcut.

**Ellipse properties from menu bar**

1. Select the border from the ellipse which should be edited.
2. Select **Edit > Edit the selected object** menu item to display the ellipse properties PopUP window.

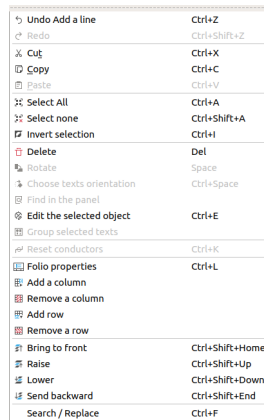

Figure: QElectroTech edit menu

**Ellipse properties by right click**

1. Right click on the border from the ellipse which should be edited.
2. Select the option **Edit the selected object** to display the ellipse properties PopUP window.

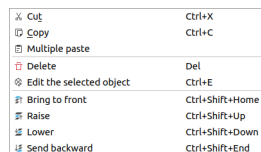

Figure: QElectroTech ellipse selection PopUP window

**Ellipse properties from selection properties panel**

1. Select one the border from the ellipse which should be edited and the properties from the ellipse will appear at [selection properties panel](#).

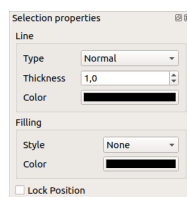

Figure: QElectroTech ellipse properties panel

**Note**

If the [selection properties panel](#) is not displayed, it can be displayed from **Settings > Display > Selection properties**

**Ellipse properties using keyboard shortcut**

QElectroTech allows using keyboard shortcut to increase the working efficiency.

1. Select the border from the ellipse which should be edited.
2. Press `Ctrl + e` to display the ellipse properties PopUP window.

#### Seealso

For more information about QElectroTech keyboard shortcuts, refer to [menu bar](#) section.

## *Polygon*

### *Create polygon*

#### **Note**

To draw more easily, the folio grid can be displayed from **Display > Display the grid** or from [toolbar](#) icon .

The polygon can only be added to the [workspace](#) by [toolbar](#).

1. Select the icon  from the [toolbar](#) to add a polygon.
2. Draw connected lines by simple click on the beginning and end point from each line.
3. Doble Click on the end vertex/point from the polygon.

#### **Note**

At everytime from the polygon creation, the previous line can be deleted without stopping the creation process.

- Right click will delete the previous line without losing all previous work.

#### **Note**

If the [toolbar](#) is not displayed, it can be displayed from **Settings > Display > Add**.

## *Polygon properties*

A polygon is a plane figure generated by a finite number of line segments connected. When the initial and end line segments from the polygon are connected, the polygon defines a closed area.

When the polygon do not define a closed area, the properties from the polygon object are the same as a [line object](#).

When the poligon defines a closed area, the **Closed polygon** check button from the polygon properties panel is selected, the polygon object has the same propertias as a [rectangle object](#).

#### **Note**

If the initial and the end line segments from the polygon are not connected when the **Closed polygon** check button is selected, a new line segment which connects both segments will be automatically generated.

The polygon properties can be displayed from [menu bar](#), by right click on one polygon edge/line, from selection properties panel and using keyboard shortcut.

**Polygon properties from menu bar**

1. Select one of the edges/lines from the polygon which should be edited.
2. Select **Edit > Edit the selected object** menu item to display the polygon properties PopUP window.

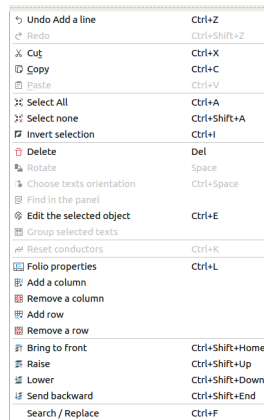

Figure: QElectroTech edit menu

**Polygon properties by right click**

1. Right click on one of the edges/lines from the polygon which should be edited.
2. Select the option **Edit the selected object** to display the polygon properties PopUP window.

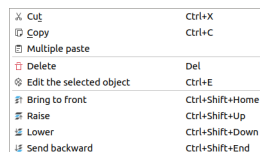

Figure: QElectroTech polygon selection PopUP window

**Polygon properties from selection properties panel**

1. Select one of the edges/lines from the polygon which should be edited and the properties from the polygon will appear at [selection properties panel](#).

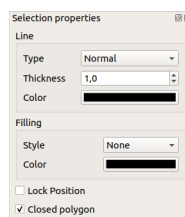

Figure: QElectroTech Polygon properties panel

**Note**

If the [selection properties panel](#) is not displayed, it can be displayed from **Settings > Display > Selection properties**

**Polygon properties using keyboard shortcut**

QElectroTech allows using keyboard shortcut to increase the working efficiency.



1. Select one of the edges/lines from the polygon which should be edited.
2. Press `Ctrl + e` to display the polygon properties PopUP window.

Seealso

For more information about QElectroTech keyboard shortcuts, refer to [menu bar](#) section.

### Add new point to polygon

1. Right click on the place from the edges/lines of the polygon where the new point should be created.
2. Select the option **Add a point** to create the new point at the polygon.

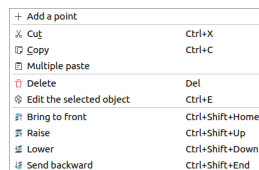

Figure: QElectroTech polygon selection PopUP window

### Delete point to polygon

1. Right click on the point from the polygon which should be deleted.
2. Select the option **Delete this point** to delete the point from the polygon.

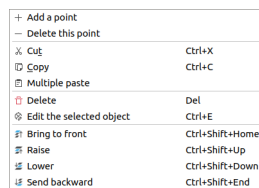

Figure: QElectroTech polygon selection PopUP window

## Working with pictures

QElectroTech allows adding and working with pictures at [folios](#). The format from the picture should be **PNG, JPG, JPEG, SVG** or **Bitmap**.

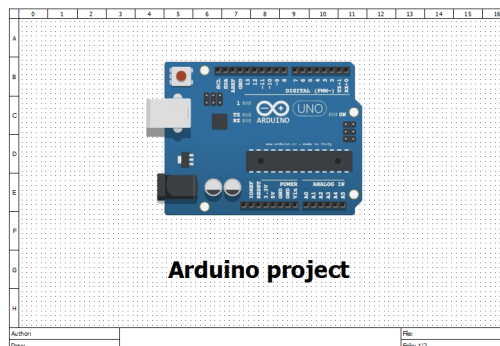



Figure: Cover Arduino project

### Add picture

1. Select the icon  from [toolbar](#) to open the search file PopUP window.

2. Select the picture at the corresponding directory.
3. Press **Open** button to add the picture.
4. Left click on the [workspace](#) area where the picture should be placed.

### Note

If the [toolbar](#) is not displayed, it can be displayed from **Settings > Display > Add**.

## Resize picture

1. Right click on the picture.
2. Select the option **Edit the image** to display the picture editor.
3. Choose the size scale desired.
4. Press **Apply** button to change the picture size.

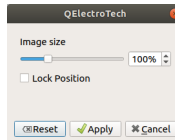

Figure: QElectroTech picture editor

### Note

The picture editor can also be displayed with double click on the picture using `Ctrl + e` shortcut keyboard.

## Move picture

1. Left click on the picture.
2. Move the picture without releasing the button.

### Note

The position from the picture can be locked to prevent involuntary movements, go to picture editor and check the **Lock Position** button.

## Select objects from workspace

### Select one object

One object ([element](#), [conductor](#), [text field](#), [basic object](#) and [picture](#)) from the [workspace](#) can be selected by a simple left click on the object.

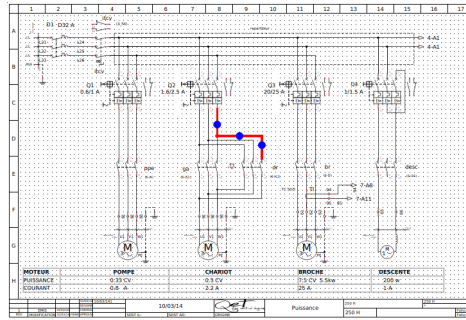

Figure: QEElectroTech schema

### Select multiple objects

As many CAD tools, many objects (elements, conductors, text fields, basic objects and pictures) from workspace can be selected in QEElectroTech at the same time.

### Select multiple objects using keyboard and mouse

QEElectroTech allows selecting multiple objects from the workspace, combining the use of keyboard and mouse.

1. Select the first object.
2. Press Ctrl.
3. Select the rest of objects without releasing Ctrl.

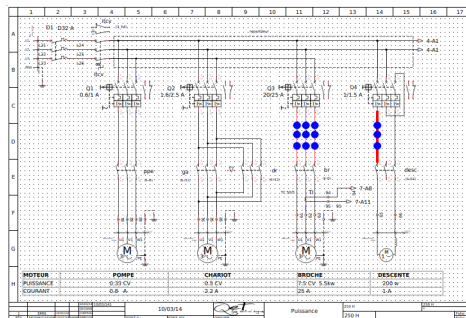

Figure: QEElectroTech schema

### Select multiple objects by selecting area

QEElectroTech allows selecting all objects from an area using the mouse to select the desired area.

1. Left click on the initial point from the rectangular area to be selected and displace the mouse without releasing up to the end point.

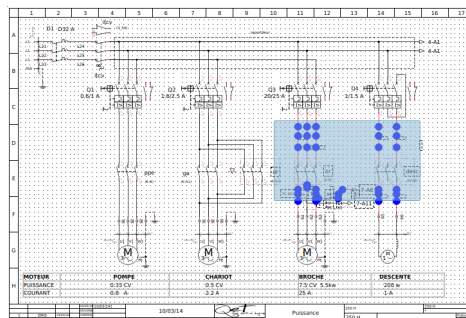

Figure: QEElectroTech selecting on workspace

### Select all objects

QElectroTech allows selecting all objet from [workspace](#), all objects from the actived [folio](#), at the same time. All objects can be selected from [menu bar](#), [workspace](#) or using the corresponding keyboard shortcut.

**Select all objects from menu bar**

1. Select **Edit > Select All** to select all objects from the activated [folio](#).

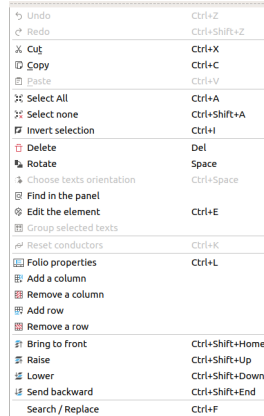

Figure: QElectroTech Edit menu

**Select all objects from workspace**

As many other CAD tools, QElectroTech allows selecting all elements from the [workspace](#), graphical area, using the mouse.

1. Left click on the initial point from the rectangular area to be selected and displace the mouse without releasing up to the end point.

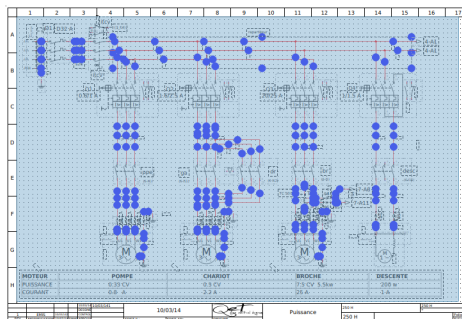

Figure: QElectroTech selecting on workspace

**Select all objects using keyboard shortcut**

QElectroTech allows using keyboard shortcut to increase the working efficiency.

1. Press `Ctrl + a` to select all objects from the activated [folio](#).

Seealso

For more information about QElectroTech keyboard shortcuts, refer to [menu bar](#) section.

**Select none**

To be sure that any object is selected before any action, QElectroTech provides the option to unselect all objects from the [workspace](#). This option is useful for avoiding undesired changes such as the [properties from an element](#).

The unselection of objects can only be done from [menu bar](#).

1. Select **Edit > Select none** to unselect all selected object.

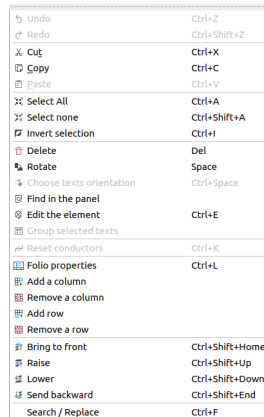

Figure: QElectroTech edit menu

### ***Invert the selection***

Some times is easier to select the objects from the [workspace](#) which are not interested for the desired action than the objects which should be selected. For this reason, QElectroTech provides the option to invert the selection.

Inverting the selection can be done from [menu bar](#) or using the corresponding keyboard shortcut.

### ***Invert selection from menu bar***

1. Select the object/s from the activated [folio](#) which are not interested for the desired action.
2. Select **Edit > Invert selection** to invert the selection.

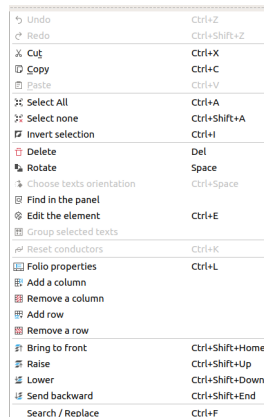

Figure: QElectroTech edit menu

### ***Invert selection using keyboard shortcut***

QElectroTech allows using keyboard shortcut to increase the working efficiency.

1. Select the object/s from the activated [folio](#) which are not interested for the desired action.
2. Press `Ctrl + i` to invert the selection.

#### Seealso

For more information about QElectroTech keyboard shortcuts, refer to [menu bar](#) section.

## Copy object

QElectroTech allows copying objects ([element](#), [conductor](#), [text field](#), [basic object](#) and [picture](#)) to [paste](#) them at the same [folio](#) or at different [folio](#) and/or [project](#) later.

### Note

Multiples objects can be copied at the same time [selecting multiple objects](#).

### Warning

The [element](#) would suffer data losses if the intention is to [paste](#) it at different [project](#).

Copying objects can be done from [menu bar](#), [toolbar](#), by right click on the object and using the corresponding keyboard shortcut.

## Copy object from menu bar

1. [Select the object/s](#) which should be copied.
2. Select **Edit > Copy** menu item to copy the object.

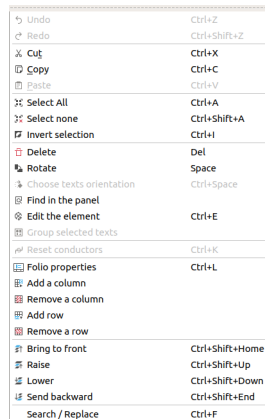



Figure: QElectroTech edit menu

## Copy object from toolbar

1. [Select the object/s](#) which should be copied.
2. Select the icon  from [toolbar](#) to copy the object.

### Note

If the [toolbar](#) is not displayed, it can be displayed from **Settings > Display > Tools**.

## Copy object by right click

1. Right click on the object which should be copied.
2. Select the option **Copy** to copy the object.

X Cut	Ctrl+X
Copy	Ctrl+C
Multiple paste	
Delete	Del
Rotate	Space
Find in the panel	
Edit the element	Ctrl+E
Bring to front	Ctrl+Shift+Home
Raise	Ctrl+Shift+Up
Lower	Ctrl+Shift+Down
Send backward	Ctrl+Shift+End

Figure: QElectroTech right click PopUP window

### Copy object using keyboard shortcut

QElectroTech allows using keyboard shortcut to increase the working efficiency.

1. Select the object/s which should be copied.
2. Press `Ctrl + c` to copy the object.

Seealso

For more information about QElectroTech keyboard shortcuts, refer to [menu bar](#) section.

### Cut object

QElectroTech allows cutting objects ([element](#), [conductor](#), [text field](#), [basic object](#) and [picture](#)) to [paste](#) them at the same [folio](#) or at different [folio](#) and/or [project](#) later.

#### Note

Multiples objects can be cut at the same time [selecting multiple objects](#).

#### Warning

The [element](#) would suffer data losses if the intention is to [paste](#) it at different [project](#).

Cutting objects can be done from [menu bar](#), [toolbar](#), by right click on the object and using the corresponding keyboard shortcut.

### Cut object from menu bar

1. Select the object/s which should be cut.
2. Select **Edit > Cut** menu item to cut the object.

Undo	Ctrl+Z
Redo	Ctrl+Shift+Z
X Cut	Ctrl+X
Copy	Ctrl+C
Paste	Ctrl+V
Select All	Ctrl+A
Select none	Ctrl+Shift+A
Invert selection	Ctrl+I
Delete	Del
Rotate	Space
Choose texts orientation	Ctrl+Space
Find in the panel	
Edit the element	Ctrl+E
Group selected texts	
Reset conductors	Ctrl+K
Folio properties	Ctrl+L
Add a column	
Remove a column	
Add row	
Remove a row	
Bring to front	Ctrl+Shift+Home
Raise	Ctrl+Shift+Up
Lower	Ctrl+Shift+Down
Send backward	Ctrl+Shift+End
Search / Replace	Ctrl+F

Figure: QElectroTech edit menu

### Cut object from toolbar

1. Select the object/s which should be cut.
2. Select the icon  from toolbar to cut the object.

#### Note

If the toolbar is not displayed, it can be displayed from **Settings > Display > Tools**.

### Cut object by right click

1. Right click on the object which should be cut.
2. Select the option **Cut** to cut the object.

X Cut	Ctrl+X
C Copy	Ctrl+C
P Multiple paste	
Del Delete	Del
R Rotate	Space
F Find in the panel	
E Edit the element	Ctrl+E
F Bring to front	Ctrl+Shift+Home
U Raise	Ctrl+Shift+Up
L Lower	Ctrl+Shift+Down
B Send backward	Ctrl+Shift+End

Figure: QElectroTech right click PopUP window

### Cut object using keyboard shortcut

QElectroTech allows using keyboard shortcut to increase the working efficiency.

1. Select the object/s which should be cut.
2. Press `Ctrl + x` to cut the object.

#### Seealso

For more information about QElectroTech keyboard shortcuts, refer to [menu bar](#) section.

### Paste object

QElectroTech allows pasting objects ([element](#), [conductor](#), [text field](#), [basic object](#) and [picture](#)) which has already been copied or cut at the same folio or at different folio and/or project.

#### Note

Multiples objects can be pasted at the same time copying or cutting multiple objects.

#### Warning

The [element](#) would suffer data losses if the intention is to paste it at different [project](#).



Pasting objects can be done from [menu bar](#), [toolbar](#), by right click at the [workspace](#) and using the corresponding keyboard shortcut.

### Paste object from menu bar

1. Select **Edit > Paste** menu item to paste at the active [folio](#) an object [copied](#) or [cut](#) previously.

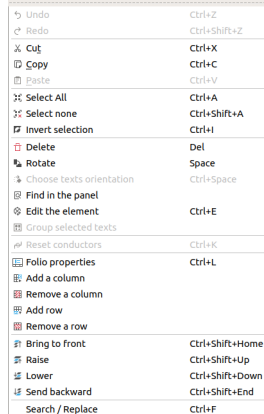



Figure: QElectroTech edit menu

### Paste object from toolbar

1. Select the icon  from [toolbar](#) to paste at the active [folio](#) an object [copied](#) or [cut](#) previously.

#### Note

If the [toolbar](#) is not displayed, it can be displayed from **Settings > Display > Tools**.

### Paste object by right click

1. Right click at the [workspace](#) area where the object should be pasted.
2. Select the option **Paste Here** to paste an object [copied](#) or [cut](#) previously.

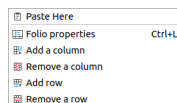

Figure: QElectroTech right click PopUP window

### Paste object using keyboard shortcut

QElectroTech allows using keyboard shortcut to increase the working efficiency.

1. Press `Ctrl + v` to paste at the active [folio](#) an object [copied](#) or [cut](#) previously.

#### Seealso

For more information about QElectroTech keyboard shortcuts, refer to [menu bar](#) section.

### Multiple paste

For making more efficient the schema creation, QElectroTech provides the feature multiple paste. This feature allows **copying** and **pasting** one or more objects automating some object definition actions.

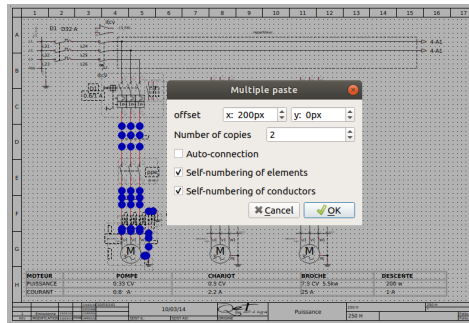

Figure: QElectroTech multiple paste

As a difference to the standard **copy** and **paste** feature, the multiple paste feature provides the following options:

- **Copy** and **paste** an object (**element**, **conductor**, **text field**, etc.) multiple times in one action.
- Use QElectroTech auto-connection feature for **element terminals** which are at the same horizontal or vertical line.
- Self-numbering of the copied **element/s**, the **standard copy** feature does not allow using auto-numbering patterns.
- Self-numbering of the copied/created **conductor/s**, the **standard copy** feature does not allow using auto-numbering patterns.

To copy and paste multiple times one or more object:

1. **Select the object/s** which should be copied.
2. Right click on the selected object/s.

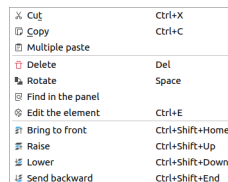

Figure: QElectroTech element right click PopUP window

3. Select the option **Multiple paste** to display the multiple paste PopUP window.

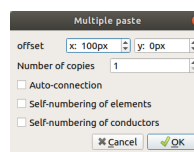

Figure: QElectroTech multiple paste PopUP window

4. Define the **x** and **y** offset between original and copy/copies.
5. Define the number of copies desired.
6. Click the desired options about **auto-connection**, **self-numebering of elements** and **self-numebering of conductors**.
7. Press **OK** Button to close the multiple paste PopUP window and create the copies.

## Delete object

Choosing the correct **element**, **conductor**, **text field**, etc. from the beginning is always nice, even so, QElectroTech allows deleting all type of object that can be add to the folios (**element**, **conductor**, **text field**, **basic object** and **picture**).

## Note

Multiples objects can be deleted at the same time [selecting multiples object](#).

Deleting objects can be done from [menu bar](#), [toolbar](#), by right click on the object and using the corresponding keyboard shortcut.

### Delete object from menu bar

1. [Select the object/s](#) which should be delete.
2. Select **Edit > Delete** menu item to delete the object.

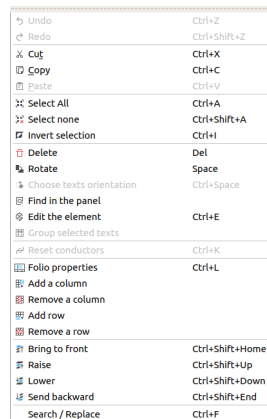



Figure: QElectroTech edit menu

### Delete object from toolbar

1. [Select the object/s](#) which should be deleted.
2. Select the icon  from [toolbar](#) to delete the object.

## Note

If the [toolbar](#) is not displayed, it can be displayed from **Settings > Display > Tools**.

### Delete object by right click

1. Right click on the object which should be deleted.
2. Select the option **Delete** to delete the object.

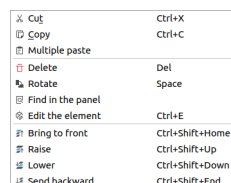

Figure: QElectroTech right click PopUP window

### Delete object using keyboard shortcut

QElectroTech allows using keyboard shortcut to increase the working efficiency.

1. [Select the object/s](#) which should be deleted.
2. Press `delete` to delete the object.

Seealso

For more information about QElectroTech keyboard shortcuts, refer to [menu bar](#) section.

## Rotate object

QElectroTech allows choosing the orientation from many object which are represented at the [folio](#). The objects which orientation can be choosed are the following:

- [Element](#)
- [Picture](#)
- [Text field](#)

QElectroTech does not allow all orientations for the objects mentioned before, only 4 different orientations are possible: **0**, **90**, **180** and **270** degrees.

### Note

QElectroTech only offers the possibility to rotate **90** degree on the clock direction.

- To rotate **180** degrees the actions should be repited once.
- To rotate **270** degrees the actions should be repited twice.

### Note

Multiples objects can be rotated at the same time [selecting multiples object](#)

Rotating objects can be done from [menu bar](#), [toolbar](#), by right click on the object and using the corresponding keyboard shortcut.

## Rotate object from menu bar

1. [Select the object](#) which should be rotated.
2. Select **Edit > Rotate** menu item to rotate the object.

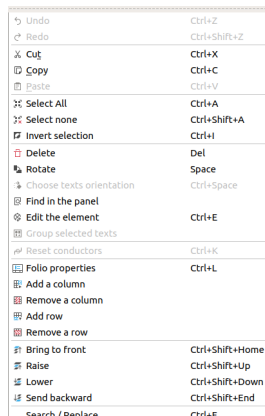



Figure: QElectroTech Edit menu

### Rotate object from toolbar

1. Select the object which should be rotated.
2. Select the icon  from toolbar to rotate the object.

#### Note

If the toolbar is not displayed, it can be displayed from **Settings > Display > Tools**.

### Rotate object by right click

1. Right click on the object which should be rotated.
2. Select the option **Rotate** to delete the object.











	Cut	Ctrl+X
	Copy	Ctrl+C
	Multiple paste	
	Delete	Del
	Rotate	Space
	Find in the panel	
	Edit the element	Ctrl+E
	Bring to front	Ctrl+Shift+Home
	Raise	Ctrl+Shift+Up
	Lower	Ctrl+Shift+Down
	Send backward	Ctrl+Shift+End

Figure: QElectroTech right click PopUP window

### Rotate object using keyboard shortcut

QElectroTech allows using keyboard shortcut to increase the working efficiency.

1. Select the object which should be rotated.
2. Press Space to rotate the object.





#### Seealso

For more information about QElectroTech keyboard shortcuts, refer to [menu bar](#) section.

### Object layer level

Overlapping of [elements](#) or [pictures](#) may occur at [workspace](#), QElectroTech allows defining the level order from [elements](#) and [pictures](#) at each [folio](#).

QElectroTech allows the following actions:

Icon	Action	Definition	Keyboard shortcut
	Bring to front	Brings the selection (s) to front	Ctrl + Shift + Home
	Raise	Approchs the selection (s)	Ctrl + Shift + Up
	Lower	Moves away the selection (s)	Ctrl + Shift + Down
	Send backwards	Sends in the backwards the selection (s)	Ctrl + Shift + End

#### Note

The layer level from multiples objects can be defined at the same time [selecting multiple objects](#).

The level from each [element](#) or [picture](#) can be defined from [menu bar](#), [toolbar](#), by right click on the object and using the corresponding keyboard shortcut.

### Define object layer from menu bar

1. Select the [object/s](#) which layer level should be defined.
2. Select **Edit** menu and the desired action.

↶ Undo	Ctrl+Z
↷ Redo	Ctrl+Shift+Z
✂ Cut	Ctrl+X
📄 Copy	Ctrl+C
📄 Paste	Ctrl+V
🔍 Select All	Ctrl+A
🔍 Select none	Ctrl+Shift+A
🔍 Invert selection	Ctrl+I
🗑 Delete	Del
🔄 Rotate	Space
⏴ Choose texts orientation	Ctrl+Space
🔍 Find in the panel	
🔍 Edit the element	Ctrl+E
📄 Group selected texts	
🔄 Reset conductors	Ctrl+K
📄 Folio properties	Ctrl+L
➡ Add a column	
➡ Remove a column	
➡ Add row	
➡ Remove a row	
📄 Bring to front	Ctrl+Shift+Home
📄 Raise	Ctrl+Shift+Up
📄 Lower	Ctrl+Shift+Down
📄 Send backward	Ctrl+Shift+End
🔍 Search / Replace	Ctrl+F

Figure: QElectroTech Edit menu

### Define object layer from toolbar

1. Select the [object/s](#) which layer level should be defined.
2. Select the corresponding icon from [toolbar](#) (icons from above table) to realize the desired action.

#### Note

If the [toolbar](#) is not displayed, it can be displayed from **Settings > Display > Depth**

### Define object layer by right click

1. Select the [object/s](#) which layer level should be defined.
2. Right click and select the desired layer definition action.

✂ Cut	Ctrl+X
📄 Copy	Ctrl+C
📄 Multiple paste	
🗑 Delete	Del
🔄 Rotate	Space
🔍 Find in the panel	
🔍 Edit the element	Ctrl+E
📄 Bring to front	Ctrl+Shift+Home
📄 Raise	Ctrl+Shift+Up
📄 Lower	Ctrl+Shift+Down
📄 Send backward	Ctrl+Shift+End

Figure: QElectroTech element right click items

### Define object layer using keyboard shortcut

As many other tools, QElectroTech is an applications which allows using keyboard shortcut.

1. Select the [object/s](#) which layer level should be defined.
2. Press the corresponding keyboard shortcut (keyboard shortcut from above table) to realize the desired action.

**Seealso**

For more information about QElectroTech keyboard shortcuts, refer to [menu bar](#) section.

**Search**

To find information inside a [schema](#) easily, QElectroTech provides a searching feature. This feature allows finding automatically [folios](#), [elements](#), [conductors](#) and [text fields \(plain text\)](#) which contains a string at one of the properties.

To find an object which contains a string:

1. Go to [search menu](#).

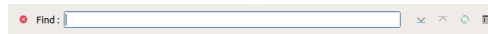

Figure: QElectroTech search menu

2. Write the string which should be search over the [project](#) in the text box from the menu.
3. Press **Intro** and QElectroTech will zoom and display the first object from the list of matches at the [workspace](#).
4. Press **↓** or **↑** button to zoom the next or previous object from the list of matches.
5. Press **↻** button to refresh the search.

**Note**

If the [search menu](#) is not displayed, it can be displayed from **Edit > Search / Replace** menu item or using **Ctrl + f** shortcut keyboard.

QElectrotech provides also some advanced properties for searching. Before searching, a filter can be dedined to reduce the list of matches according the following criteria:

- [Text fields \(Plain text\)](#).
- [Whole words \(Text fields \(Plain text\), Conductor properties, Element properties, Folio properties\)](#)

To create an advanced search:

1. Go to [search menu](#).
2. Press **≡** button to display the filter tree.

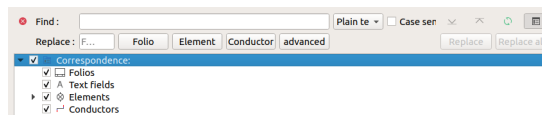

Figure: QElectroTech advanced search menu

3. Select the type of text to be searched (**Plain text** or **Whole words**) at the combobox from the right side of the text box.
4. Click / unclick the button which selects **Case sensitive**.
5. From here, follow the steps from the standard search.

**Replace****Replace text field content**

QElectroTech provides the feature of searching and replacing **text field** content automatically. This option allows replacing the complete content from a **text field** which contains the string searched. The string searched can be the complete **text field** content or part of the **text field** content.

### Note

If the **search menu** is not displayed, it can be displayed from **Edit > Search / Replace** menu item.

To replace **text field** content over a **project**:

1. **Search** the string which should be replaced (Ex.: Folio).

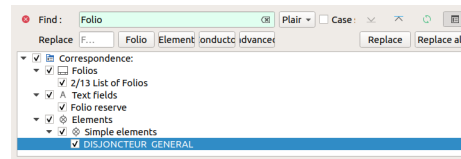

Figure: QElectroTech search menu

2. Define the new text content at the replace text box (Ex.: Sheet reserve).

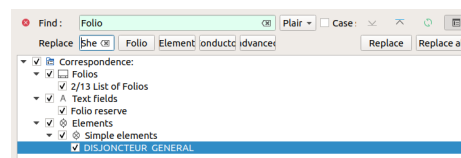





Figure: QElectroTech search menu

3. Select at the objects tree the **text fields** which content should be replaced.
4. Press **Replace all** button to replace the content from the selected **text fields**.
5. Press actualize  button to refresh the search.

### Note

Replacing action can also be applied object by object. The button **Replace** will only apply the action to the displayed object at the **workspace**. The buttons  and  can be used to display the previous and next **text field** from the search result.

### Warning

The replacing feature from QElectroTech replaces the **text field** content completely. Changing the **text field** content partly cannot be done.

### Replace folio property

QElectroTech provides the feature of automatic searching of **folios** with an specific property for replacing **folio properties** without the need of opening the folio properties PopUp window.

### Note

If the **search menu** is not displayed, it can be displayed from **Edit > Search / Replace** menu item.



To replace some **folio** properties:

1. **Search** the content which should identify the **folio** from which a property has to be changed.

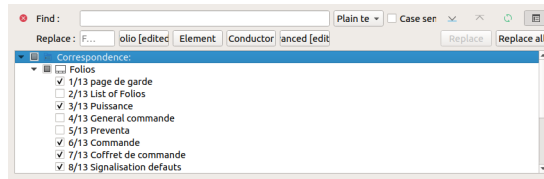

Figure: QElectroTech search menu

2. Press the **Folio** button to display the folio properties PopUp window.

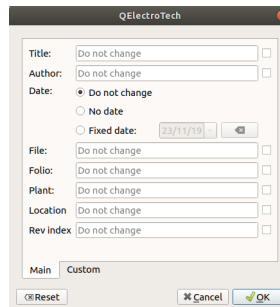

Figure: QElectroTech folio properties replace PopUp windows



3. Fill the text line box from the **folio** property/ies which should be changed.

### Note

QElectroTech also allows deleting and making empty a filled property. Click at the right check button from the **folio** property/ies which should be deleted.

4. Press **Accept**.
5. From the **folios** found at the search process, select the **folios** where the replace action have to be applied. The selection can be made at the object tree from the **search menu**.
6. Press **Replace all** button to apply the replace action to all selected **folios**.

### Note

Replacing action can also be applied **folio** by **folio**. The button **Replace** will only apply the action to the displayed **folio** at the **workspace**. The buttons  and  can be used to display the previous and next **folio** from the search result.

### Replace element property

QElectroTech provides the feature of automatic searching of **element** with an specific property for replacing **element** **properties** without the need of searching the **element** manually around the project.

### Note

If the **search menu** is not displayed, it can be displayed from **Edit > Search / Replace** menu item.

To replace some **element properties**:

1. **Search** the property (Manufacturer, Lable, etc.) which identifies the **element** from which a property has to be changed.

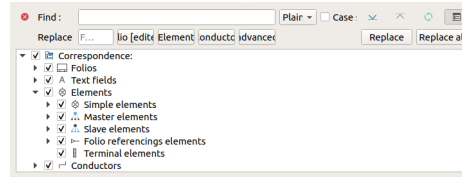

Figure: QElectroTech search menu

2. Press the **Element** button to display the element properties PopUp window.

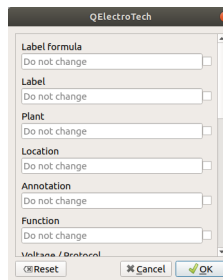

Figure: QElectroTech element properties replace PopUp windows

3. Fill the text line box from the **element property/ies** which should be changed.

### Note

QElectroTech also allows deleting and making empty a filled property. Click at the clicked button from the **element property/ies** which should be deleted.

4. Press **Accept**.
5. From the **elements** found at the search process, select the **elements** where the replace action have to be applied. The selection can be made at the object tree from the **search menu**.
6. Press **Replace all** button to apply the replace action to all selected **elements**.

### Note

Replacing action can also be applied **element by element**. The button **Replace** will only apply the action to the displayed **element** at the **workspace**. The buttons  and  can be used to display the previous and next **element** from the search result.

### Replace conductor property

QElectroTech provides the feature of automatic searching of **conductor** with an specific property for replacing **conductor properties** without the need of searching the **conductor** manually around the project.

### Note

If the **search menu** is not displayed, it can be displayed from **Edit > Search / Replace** menu item.

To replace some **conductor properties**:

1. **Search** the property (Manufacturer, Lable, etc.) which identifies the **conductor** from which a property has to be changed.

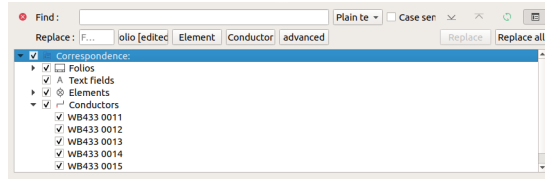

Figure: QElectroTech search menu

2. Press the **Conductor** button to display the conductor properties PopUp window.

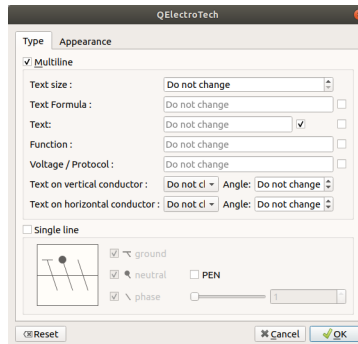

Figure: QElectroTech conductor properties replace PopUp windows



3. Fill the text line box from the **conductor property/ies** which should be changed.

### Note

QElectroTech also allows deleting and making empty a filled property. Click at the cliked button from the **conductor property/ies** which should be deleted.

4. Press **Accept**.
5. From the **conductors** found at the search process, select the **conductors** where the replace action have to be applied. The selection can be made at the object tree from the **search menu**.
6. Press **Replace all** button to apply the replace action to all selected **conductors**.

### Note

Replacing action can also be applied **conductor** by **conductor**. The button **Replace** will only apply the action to the displayed **conductor** at the **workspace**. The buttons  and  can be used to display the previous and next **conductor** from the search result.

### Advanced replace

QElectroTech provides the possibility to define a string and replace if for a new defining some conditions:

- a. Type of object.
- b. Object property with the defined value.
- c. Filtering **folio**, **type of element**, etc.

**Note**

If the [search menu](#) is not displayed, it can be displayed from **Edit > Search / Replace** menu item.

To replace text information from project objects:

1. Press **advanced** button to display advanced replace PopUp window.
2. Define QElectroTech object type from **Who** combobox (Ex.: **Element**).

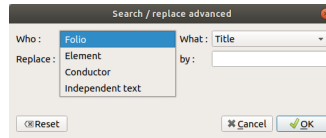

Figure: QElectroTech advanced replace PopUp window

3. Define object property type from **What** combobox (Ex.: **Manufacturer**).

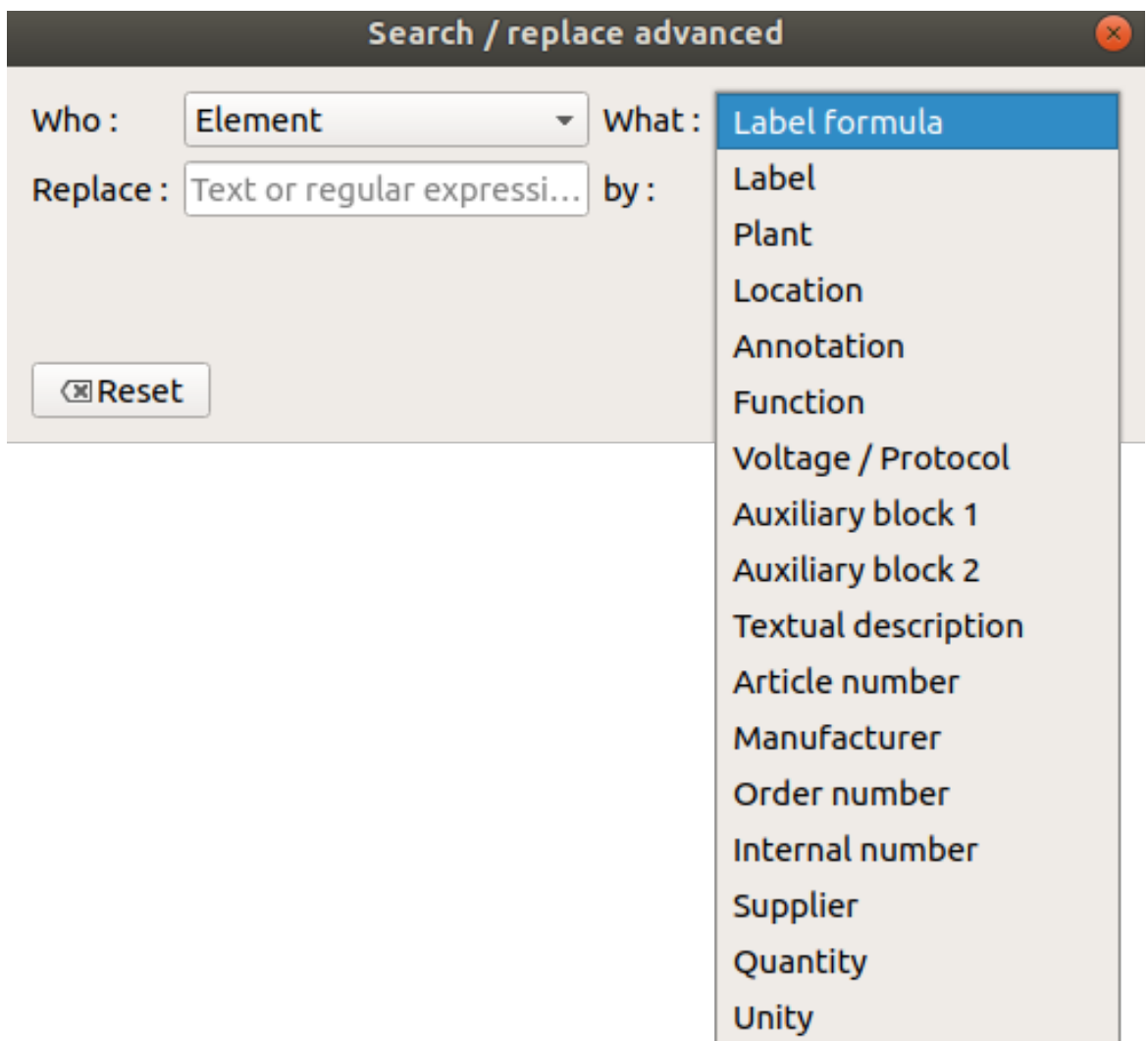

Figure: QElectroTech advanced replace PopUp window

4. Define the property value which should be replaced in the **Replace** text box (Ex.: SIEMENS).
5. Define the new property value at the replace text box in the **By** text box (Ex.: SCHNEIDER).

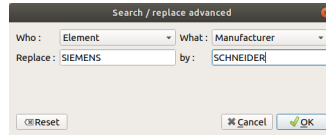

Figure: QElectroTech advanced replace PopUP window

3. Press **OK** button to storage the desired replacing conditions.
4. Filter in the object tree the **folios** where the action should be applied.

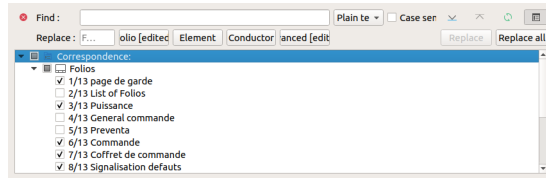

Figure: QElectroTech search menu element properties PopUP window

6. Press **Replace all** button to apply the replace action.

## Drawing

### Design mounting plate

QElectroTech is not only a tool for diagrams and shemas, QElectroTech allows also drawing 2D drawings. Electrical boxes, buttons, switches, screens and any other type of components can be drawn at the [workspace](#).

2D drawings from electrical component can be created at the [element editor](#) as [elements](#). After the creation of component drawings, assembled panel drawings can be created introducing the [elements](#) at the [workspace](#). At the category **Graphics** from [QET collection](#) some common electrical components front views are provided as [elements](#).

#### Note

For more information about how to create [elements](#), refer to [Create or edit element](#) section.

For more information about how to introduce [elements](#) at [workspace](#), refer to [Working with element](#) section.

The advantage of drawing mounting plates using QElectroTech and not with a different CAD tool is the possibility to create links between the [elements](#). A link between the [elements](#) which represents the electrical component at the [schema](#) and the [elements](#) which represents the component at the drawing will reduce the future effort; the effort from the manufacturing, intallation and maintenace phase of the project.

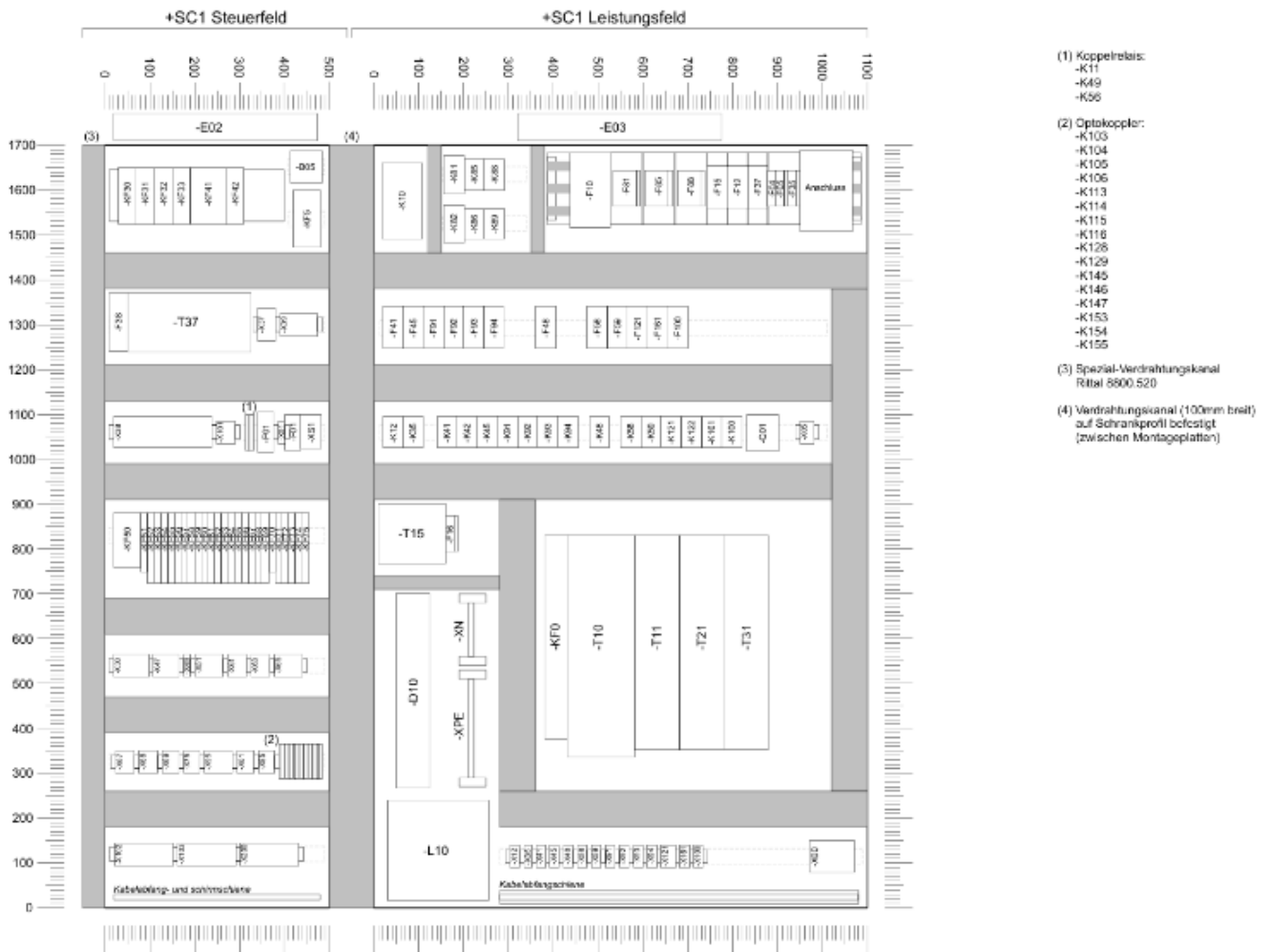

Figure: QElectroTech Mounting plate example

## Design Local Control Panel (LOP)

QElectroTech is not only a tool for diagrams and shemas, QElectroTech allows also drawing 2D drawings. Electrical boxes, buttons, switches, screens and any other type of components can be drawn at the [workspace](#).

2D drawings from electrical component can be created at the [element editor](#) as [elements](#). After the creation of component drawings, assembled panel drawings can be created introducing the [elements](#) at the [workspace](#). At the category **Graphics** from [QET collection](#) some common electrical components front views are provided as [elements](#).

### Note

For more information about how to create [elements](#), refer to [Create or edit element](#) section.

For more information about how to introduce [elements](#) at [workspace](#), refer to [Working with element](#) section.

The advantage of drawing control panels using QElectroTech and not with a different CAD tool is the possibility to create links between the [elements](#). A link between the [elements](#) which represents the electrical component at the [schema](#) and the [elements](#) which represents the component at the drawing will reduce the future effort; the effort from the manufacturing, intallation and maintenace phase of the project.

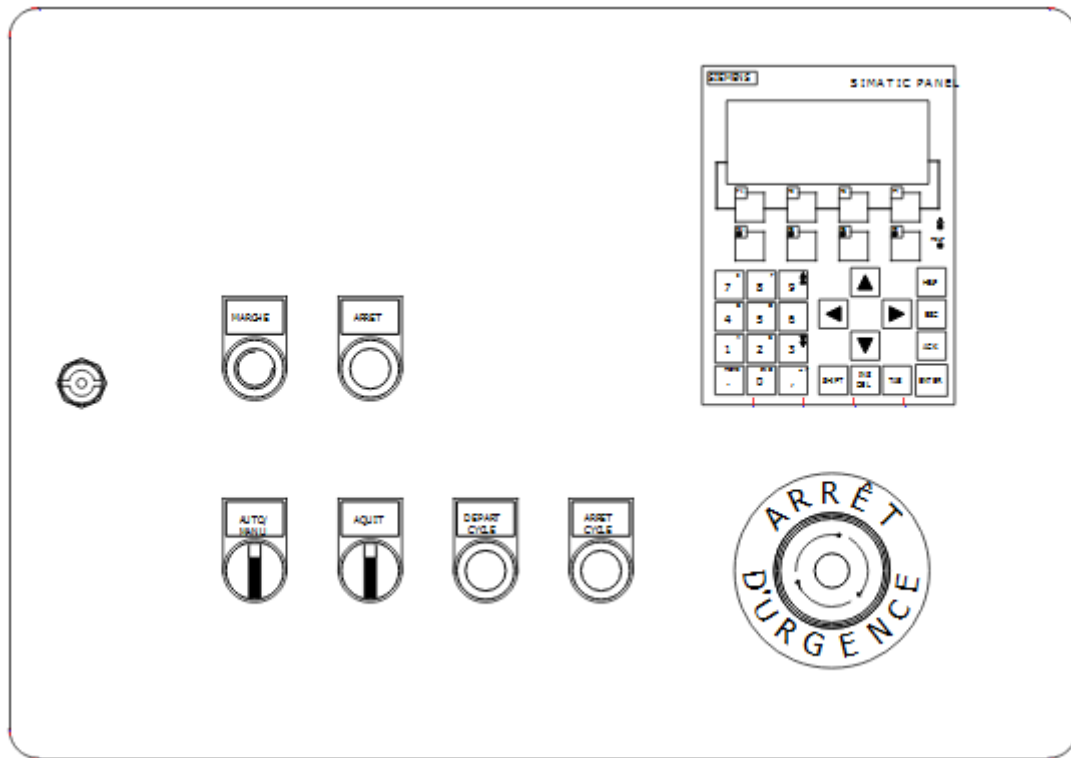

Figure: QElectroTech Local Control Panel example

## Reports

### Project index

A [project](#) can be a group of [folios](#), for this reason the possibility to make index which shows some information about the different [folios](#) is necessary. QElectroTech allows creating this index as a table in an automatic way, see figure below.

Folio	Title	Plants	Location	Rev	Author	Date
1	References Page					
2	List of Folios					
3	List of Folios					
4	Mains Power Supply		-IGC	1.0	IM	01/09/18
5	Auxiliary Power Supply		-IGC	1.0	IM	01/09/18
6	Emergency Stop Circuit		-IGC	1.0	IM	01/09/18
7	Emergency Stop Power		-IGC	1.0	IM	01/09/18
8	VX Gate Control Circuit		-IGC	1.0	IM	01/09/18
9	V1 Gate Control Circuit		-IGC	1.0	IM	01/09/18
10	V2 Gate Control Circuit		-IGC	1.0	IM	01/09/18
11	V3 Gate Control Circuit		-IGC	1.0	IM	01/09/18
12	V4 Gate Control Circuit		-IGC	1.0	IM	01/09/18
13	V5 Gate Control Circuit		-IGC	1.0	IM	01/09/18
14	V6 Gate Control Circuit		-IGC	1.0	IM	01/09/18
15	V7 Gate Control Circuit		-IGC	1.0	IM	01/09/18
16	A0 PLC Layout		-IGC	1.0	IM	01/09/18
17	A0 Input Module		-IGC	1.0	IM	01/09/18
18	A0 Output Module		-IGC	1.0	IM	01/09/18
19	A1/1 Input Module		-IGC	1.0	IM	01/09/18
20	A1/2 Input Module		-IGC	1.0	IM	01/09/18
21	A1 Output Module		-IGC	1.0	IM	01/09/18
22	A2/1 Input Module		-IGC	1.0	IM	01/09/18
23	A2/2 Input Module		-IGC	1.0	IM	01/09/18
24	A2 Output Module		-IGC	1.0	IM	01/09/18
25	A3/1 Input Module		-IGC	1.0	IM	01/09/18
26	A3/2 Input Module		-IGC	1.0	IM	01/09/18
27	A3 Output Module		-IGC	1.0	IM	01/09/18
28	A4/1 Input Module		-IGC	1.0	IM	01/09/18
29	A4/2 Input Module		-IGC	1.0	IM	01/09/18

Author:	List of Folios	File:
Date:		Folio: 2

Figure: QElectroTech list of folios

To create the table of folios automatically:

1. Select **Project > Add a summary** to add a new folio in second position of the project tree and create the list of folios.

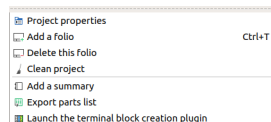

Figure: QElectroTech project menu

### Note

The list of folios can be created at any time and it will be automatically updated if any folio is added or deleted. It will also be automatically updated if any folio data is changed (ex.: revision, author, date, etc.).

### Component list

Feature still not available in QElectroTech 0.7

### Conductor list

Feature still not available in QElectroTech 0.7



## I/O list

Feature still not available in QElectroTech 0.7

## Export and print

### Print project

The active **project** can be printed from **menu bar**, **toolbar** and using the corresponding keyboard shortcut.

### Warning

Check that the active **project** is the **project** that should be printed.

### Print project from menu bar

1. Select **File > Print** menu item to open the printing PopUP window.
2. Click **Print to a physical printer** check button.

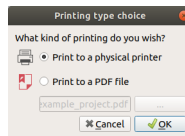

Figure: QElectroTech printing PopUP window

3. Press **Ok** Button to open the selection printer PopUp window.
4. Select printer and the preview printing PopUP window will be displayed.

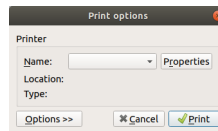

Figure: QElectroTech printing options PopUP window

5. Select the **folios** which should be printed.

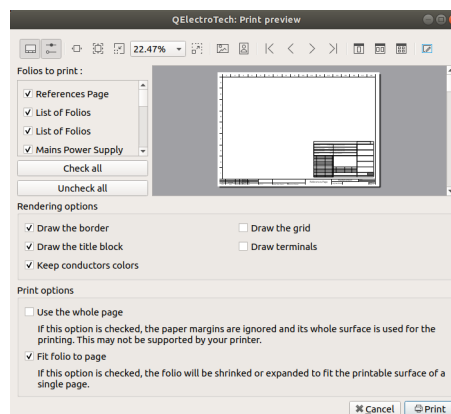





Figure: QElectroTech printing preview PopUP window

6. Select the printing option.
7. Press **Print** Button.

### Note

- If the folio list is not displayed, select the icon  from the toolbar.
- If the printing options panel is not displayed, select the icon  from the toolbar.

### Print project from toolbar

1. Select the icon  from the [toolbar](#) to open the printing PopUP window.
2. Follow the steps defined at the [printing project from menu bar](#) section.

### Note

If the [toolbar](#) is not displayed, it can be displayed from **Settings > Display > Tools**

### Print project using keyboard shortcut

QElectroTech allows using keyboard shortcut to increase the working efficiency.

1. Press `Ctrl + p` to open the printing PopUP window.
2. Follow the steps defined at the [printing project from menu bar](#) section.

#### Seealso

For more information about QElectroTech keyboard shortcuts, refer to [menu bar](#) section.

#### Seealso

QElectroTech allows predefining printing settings for reducing the working configuration effort each time that a [project](#) have to be printed, refer to [printing settings](#) section for more information.

### Create a PDF from a project

The active [project](#) can be exported to PDF from the [menu bar](#), [toolbar](#) and using the corresponding keyboard shortcut.

### Warning

Check that the active [project](#) is the [project](#) that should be printed.

### Note

The current version from QElectroTech, version 0.7, does not allow keeping the element links on the PDF document.

### Export project to PDF from menu bar

1. Select **File > Print** menu item to open the printing PopUP window.
2. Select Print to PDF a file check button.
3. Select the directory where to save the PDF file

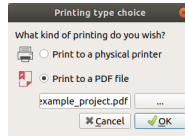

Figure: QElectroTech printing PopUP window

4. Press **Ok** Button to open the preview printing PopUP window.

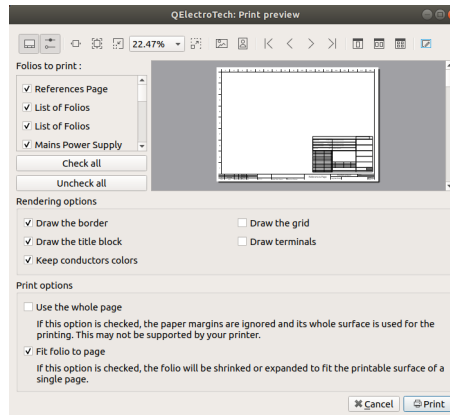





Figure: QElectroTech printing preview PopUP window

5. Select the **folios** that should be printed.
6. Select the printing option.
7. Press **Print** Button.

### Note

- If the folio list is not display, select the icon  from the toolbar.
- If the print options panel is not display, select the icon  from the toolbar.

### Export project to PDF from toolbar

1. Select the icon  from the **toolbar** to open the printing PopUP window.
2. Follow the steps defined at the **printing project** from menu bar section.

### Note

If the **toolbar** is not displayed, it can be displayed from **Settings > Display > Tools**

### Export project to PDF using keyboard shortcut

QElectroTech allows using keyboard shortcut to increase the working efficiency.

1. Press **Ctrl + p** to open the printing PopUP window.
2. Follow the steps defined at the **printing project** from menu bar section.

Seealso

For more information about QElectroTech keyboard shortcuts, refer to [menu bar](#) section.

## ***Export schema***

QElectroTech allows exporting the different [folios](#) to many type of formats: **PNG**, **JPEG**, **Bitmap**, **SVG** and **DWX**.

1. Select **File > Export** menu item to display exporting PopUP window.

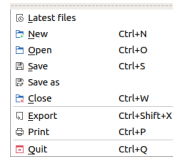

Figure: QElectroTech file menu

## Note

QElectroTech allows using keyboard shortcuts to increase the working efficiency.

1. Press **Ctrl + Shift + X** to display exporting PopUP window.

For more information about QElectroTech keyboard shortcut, refer to [menu bar](#) section.

2. Choose the **folios** you wish to export and specify their size.

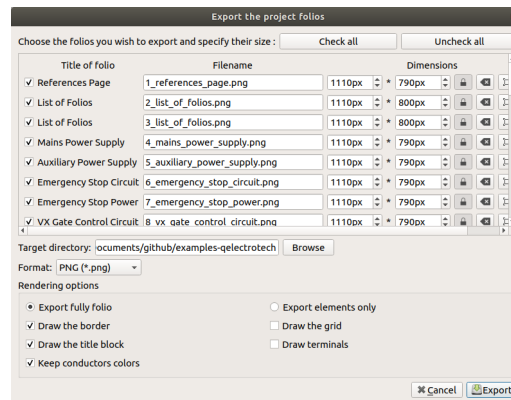

Figure: QElectroTech export PopUP window

3. Choose target directory and format.

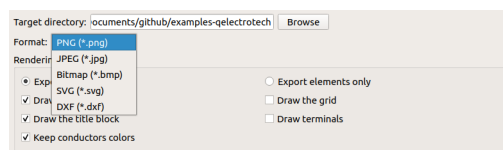

Figure: QElectroTech exporting formats combo box

4. Choose rendering options.

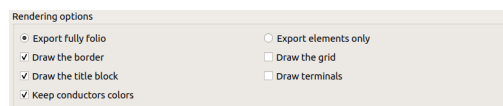

Figure: QElectroTech rendering options

5. Press **Export** button to create the files.

QElectroTech creates one file for each folio choosed at the target directory defined.

## Seealso

QElectroTech allows predefining exporting settings for reducing the working configuration effort each time that a [project](#) have to be exported, refer to [export settings](#) section for more information.

## Export component list

QElectroTech allows creating a CSV file which contains a list of all elements from the project. The CSV file can be opened and edited with tools as [LibreOffice Calc](#).

The different field properties are listed by columns and the elements are ordered by folio.

To export the component list to CSV file:

1. Select **Project > Export parts list** menu item to open the exporting PopUP window.
2. Choose target directory.
3. Press **Save** button to create the file with extension `.csv`.

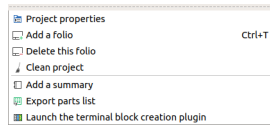

Figure: QElectroTech project menu

## Annex

### Default QElectroTech variables

To systematize title block templates and allow auto numbering of elements, conductors and folios; QElectroTech provides the possibility to work with variables.

The variables are used to define the content of text field and properties from elements, folios and conductors. Depending on the conditions during the creation of the object (folio, element, conductor, etc.) The variable of the text or property field is replaced by a different value.

A property is identified as a string which starts with the symbol `%`. The default variables provided by ElectroTech can be found at this section.

### General project variables

The following variables are global variables which can be used to create title block templates.

- `% {projecttitle}`: Project title
- `% {projectpath}`: Project path
- `% {projectfilename}`: Project file name
- `% {saveddate}`: File saving date
- `% {filename}`: Project file name
- `% {savedfilename}`: Registered file name
- `% {savedfilepath}`: Saved file path
- `% {savedtime}`: File saving time
- `% {folio-total}`: Total number of folios in the project
- `% {version}`: Software version
- `% {machine}`: Project functional group name

### variables related to folio

The following variables are specific variables for each folio. They can be used to create title block templates.

- % **{folio-id}**: Folio position in the project
- % **{title}**: Folio title
- % **{author}**: Folio author
- % **{date}**: Folio date
- % **{folio}**: Folio information (Label)
- % **{indexrev}**: Folio revision index
- % **{locmach}**: Name of the location in the project functional group
- % **{previous-folio-num}**: Number previous folio
- % **{next-folio-num}**: Number next folio

### ***variables related to element***

The following variables are specific variables for each element. They can be used to create auto numbering patterns.

- % **{F}**: Label from the folio where the element can be found
- % **{f}**: Number from the folio where the element can be found
- % **{M}**: Plant variable from the folio where the element can be found
- % **{LM}**: Location variable of the folio where the element can be found
- % **{l}**: Folio line number from the workspace where the element can be found
- % **{c}**: Folio column number from the workspace where the element can be found
- % **{id}**: Folio position in the project (Schema number)

### ***variables related to conductor***

The following variables are specific variables for each conductor. They can be used to create auto numbering patterns.

- % **{F}**: Label from the folio where the conductor can be found
- % **{f}**: Number from the folio where the conductor can be found
- % **{M}**: Plant variable from the folio where the conductor can be found
- % **{LM}**: Location variable of the folio where the conductor can be found
- % **{l}**: Folio line number from the workspace where the conductor can be found
- % **{c}**: Folio column number from the workspace where the conductor can be found
- % **{id}**: Folio position in the project (Schema number)

### ***QElectroTech text font***

To define the text font at the **Select font** PopUP window:

1. Search for the font using the searching box or using the scrollbar from right side.
2. Click on the text font in the list box.
3. Defin font size by horizontal scrollbar, defining the size in the text box or using +/- buttons.

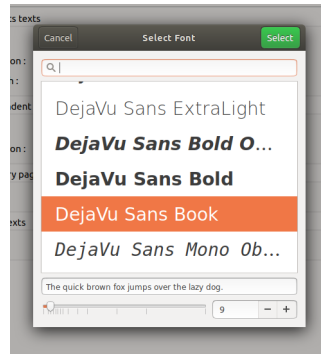

Figure: QElectroTech select font PopUp window

## Color selection

### Basic color

QElectroTech provides a **Select color** PopUp window with some basic colors.

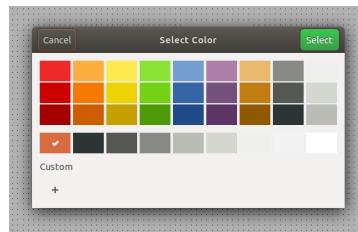

Figure: QElectroTech basic color selector

To select a color:

1. Click on the desired color.
2. Press **Select** button.

The **Select color** PopUp window is also provided with a custom section where the colors defined in the past are stored.

### Custom color

QElectroTech allows customizing colors by defining the HTML code.

To define a custom color:

1. Press the button + from the custom color section of the **Select color** PopUp window.
2. Define the HTML code of the desired color in the text box.

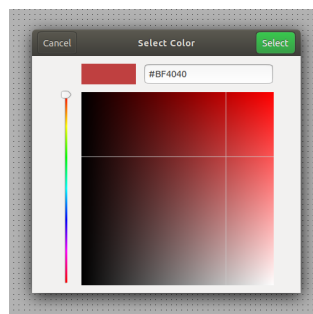

Figure: QElectroTech custom color selector

3. Press **Select** button to add the new color to the custom section of the **Select color** PopUp window.



## **Note**

The custom color can also be defined visually:

1. The color scale can be defined by the scrollbar placed at left side.
2. The grays scale can be defined by a cursor click on the color scale.

## Seealso

For more information about HTML color code, refer to online resources as:

<https://htmlcolorcodes.com/>

here is the pdf version [pdf](#)