

# **EVERYMIND'S DE MORGAN'S ELEMENTS**

**The Core of Mathematics**

**R. Earle Harris**

Published 01may2019

Comments, corrections, and criticisms are welcomed.  
Rights for physical and DCM (Kindle, etc.) copies available.  
[r.earle.harris@gmx.com](mailto:r.earle.harris@gmx.com)

## Dedication

For my teacher emeritus in absentia

**Augustus De Morgan**  
1806 - 1871

I have a soft place in my heart for  
Augustus De Morgan and, for the same reason, Karl Marx.  
When these men lost their favorite grown daughters,  
they pretty much just curled up and died.  
As Einstein noted, we should have compassion for everyone.

## Watchwords

Mathematics is independent of any other branch of knowledge.  
It is autonomous, and in itself must be sought  
its nature, its structure, its laws of being.  
-- **James Byrnie Shaw**

Mathematics is an anthropological activity.  
-- **Ludwig Wittgenstein**

## Table of Contents

The Core .....	5
Preparation .....	6
<b>Arithmetic</b> .....	<b>8</b>
Sense and Meaning .....	8
Addition .....	14
Subtraction .....	17
Multiplication .....	20
Division .....	25
Fractions .....	36
Square Roots .....	45
Ratio and Proportion .....	51
Combinatorics .....	60
Number Theory .....	65
Geometry .....	70
<b>Algebra</b> .....	<b>73</b>
The Form of Number .....	74
First Degree Equations .....	79
Second Degree Equations .....	92
Limits .....	97
Functions .....	103
Series .....	111
The Binomial Theorem .....	116
Transcendental Series .....	120
<b>Trigonometry</b> .....	<b>125</b>
Basic Trig Functions .....	127
Functions of 2+ Angles .....	132
Inverse Functions .....	136
Complex Numbers .....	138
Hyperbolic Trigonometry .....	145
Solution of Triangles .....	147

[Cont'd]

Calculus .....	150
Analytic Geometry .....	150
Limits of Decreasing Ratios .....	154
Taylor's Theorem .....	156
A Geometric Viewpoint .....	159
Limits of Increasing Ratios .....	164
Partial and Total Derivatives .....	166
Derivatives and Differences .....	167
Implicit Derivatives and Functions .....	170
Integral Calculus .....	173
Afterword .....	177

## The Core

In the study of a language, when you have acquired the most common 1200-1500 words and their usage (conjugation, etc.), you have the core of that language -- about two-thirds of it by volume. These words take up two-thirds of the average page printed in that language. When you have the core, the language becomes intelligible and you move on to vocabulary building and advanced grammar acquisition.

The same idea of a core applies to any discipline, including mathematics. You can acquire the core of mathematics and, from that foundation, expand your understanding from an adequate basis. With the core, the language itself becomes intelligible and you move on to vocabulary building and advanced grammar. So what do you need in order to have the core of mathematics? You need to master Euclid, Books I - VI. And you need to master this book -- not because I say so but because I have found it to be so. Let me explain.

I have a degree in mathematics. But the world was not interested in paying me to do mathematics. And academia was in a state in which it would be very difficult to borrow to pay for graduate school and then be able to pay off one's debt. So it's been a hard time for a mathematician and, over the years, my mathematics slipped away. When I returned to the study of mathematics, I found that, while I could still do even some graduate level studies, I was not satisfied with my understanding of any of it. I was just moving symbols around. So I went back to the basics asking, "But what does all this mean?"

On [archive.org](http://archive.org), I found hundreds of math texts from the 1700s to the 1990s and somehow came across the books of Augustus De Morgan. He had written *Elements of Arithmetic* (1830), *Elements of Algebra* (1835), and *Elements of Trigonometry* (1837) in order to prepare students for college in a world where the public schools were simply teaching memorisable factoids of results. Sound familiar? Separately, but with similar intent, he wrote *On the Study and Difficulties of Mathematics* (1831), *Trigonometry and Double Algebra* (1849), *Elementary Calculus* (1832), and other similar volumes.

So I more or less began my return to mathematics with these books by Augustus De Morgan. In the years which have followed, I found that if I had mastered these books, I would have saved myself a great deal of effort. Everything I didn't solidly learn from De Morgan, I've had to learn again from someone else. And it's made me feel quite stupid for not learning it the first time. His series of *Elements* are in no way simple or trivial and everything in them continues to be encountered over and over as you progress. This book, *De Morgan's Elements*, is a condensation of the six books listed above. And I believe I have condensed it in a way that leaves nothing out which belongs to the core. If you will master this text, you will save yourself a lot of effort down the road, gain a firm foundation for understanding mathematics, and acquire its core -- minus Euclid.

In the schools, Euclid waxes and wanes. But he's still around and we haven't preserved his work for over two millennia because we love his triangles. Euclid develops the mind. If you will study the first six books of Euclid in a good text, work at solving the text's hundreds of problems, and study all the solutions, you will find yourself with a new mind. I'm not kidding. You will also gain an understanding of and the ability to construct every kind of proof but proof by induction, which is an easy thing to learn. And you will gain an understanding of pure geometry which is valuable in itself. But mostly you will develop a new mind with practical powers that you will only realize once you attain them.

## Preparation

*Mathematics is not the voice of God. It is the purest voice of reason.*

The first exercise for the would-be mathematician is to train one's mind to speak in this pure voice's language.

*You must, first of all, make sure that you have a mind: and to be sure of that is to see that the mind is the necessary outcome of a course of development.*

We all know how much of a mind we have actually developed. But most people are concerned with how theirs compares to other people's and a great deal of dishonesty is the result. Forget about other people. Mind your own business. Develop your own mind.

*The depth of the mind is only so deep as its courage to expand and lose itself in its explication.*

Some readers will be wondering: "Who is he quoting?" I'm quoting all kinds of thoughtful people. Who they are is an exercise for the reader. Chase down the ones you care about. This is not an academic text and I am not an academic. I don't do footnotes. If you need reassurance as to my pedigree, I can't help you there -- who I am is not the point:

*The disposition toward belief in authority must be checked: whatever is not gained by your own thought is not gained to any purpose. You must not trust the authority of anyone.*

That was a mathematician and this is what is meant by **course of development**.

We don't really know how mathematics was begun. So I'll skip all the stories about counting sheep by using pebbles and why ten fingers are such a big deal. You can understand mathematics without sheep, pebbles, or fingers. Our current understanding of mathematics is based upon our **truth-grounds**.

*Mathematics is an assertion that number's consequences can best be described by using our truth-grounds and operators. I wanted to add "axioms" but axioms are either a truth-ground or a cheat.*

The truth-grounds of our mathematics are the natural numbers: 1, 2, 3, ... and the four operators: +, -, ×, ÷. Everything else follows from these and everything begins with these simplest of ideas.

*In reality, our senses are our first mathematical instructors; they furnish us with notions which we cannot trace any further or represent in any other way than by using simple words which everyone understands: one, two, three, point, line, surface; all of which, let them be ever so much explained, can never be made any clearer than they already are to a child of ten years old.*

But each of these ideas is distinct.

*The idea of two is as distinct from the idea of three as the magnitude of the whole earth is from that of a mite. This is not so in other simple modes, in which it is not so easy, nor*

*perhaps possible, for us to distinguish between two approaching ideas, which yet are really distinct; for who will undertake to find a difference between the white of this paper and that of the next degree to it?*

And yet, there are many ways of expressing each distinct idea. A mathematical idea can be expressed in many contexts, falling under different laws and different modes of expression. Think of the idea as the number itself and the way it is expressed in each context as a **form of number**. Then keep in mind as we go that, regardless of context, any expression of number is subject to the laws of its every form. If any such law will work meaningfully in the current context, you can use it there -- because the idea is one.

You could also say: *There are many "figures seven" but there is but one "number seven," because "number seven" is idea, one idea. On the same principle there is but one everything.*

I have to assume you know something in order to begin. I won't assume very much, only what De Morgan seemed to assume. I will assume you understand basic arithmetic, the following laws where a, b, c are any numbers:

$$\begin{array}{ll} \text{Commutative Law:} & a+b = b+a & ab = ba \\ \text{Associative Law:} & a+(b+c) = (a+b)+c & a(bc) = (ab)c \\ \text{Distributive Law:} & a(b+c) = ab + ac & \end{array}$$

and our **positional decimal system**:

*When one has 4 thousands, 5 hundreds, 6 tens, and 7 individuals of some object, still their representation as 4567 is a "matter of choice." The choice is driven by simplicity and utility. 4567 is **our one** way of representation and facilitates the use of **our** operations upon it.*

This is a choice of representation because if the positions were nines instead of tens, 4567 would be 6234 and our "child of ten years old" would be eleven, yet not a day older. The reader who finds any of the above assumed knowledge difficult *will sooner find his way barefoot to Jerusalem than understand the greater part of this work.*

You must study this book with pencil and paper at hand. Like De Morgan, I provide few exercises. I provide the core. You provide the exercises. Just produce variations on the theme of whatever examples are in this book. Or go find examples; there are hundreds of free mathematical texts of all kinds available on-line in PDF format. You will need to work exercises to the extent of establishing these ideas in your mind. *We learn mathematics by doing mathematics* and if you don't, you won't.

# Arithmetic

## Sense and Meaning

*A serious threat to the life of science is implied in the assertion that mathematics is nothing but a system of conclusions drawn from definitions and postulates that must be consistent but otherwise may be created by the free will of the mathematician. If this description were accurate, mathematics could not attract any intelligent person. It would be a game of definitions, rules, and syllogisms without motive or goal. The notion that the intellect can create meaningful postulational systems at its whim is a deceptive half-truth. Only under the discipline of responsibility to the organic whole, only as guided by intrinsic necessity, can the free mind achieve results of scientific value.*

Without meaning, we have nothing to say.

Mathematics can be used to say things about the world and some people call this "applied mathematics" which tries to express **meaning** regarding the world. Also, mathematics can be used to say things about itself. People call this "pure mathematics" and here mathematics has an internal **sense**, independent of objects in the world. In truth, applied and pure are the same thing. The Calculus that is found in Hydrodynamics is the same Calculus that is found in Real Analysis. Identical ideas are found differently expressed in each context. For those who understand both contexts, the synergy of meaning is continuous.

And any part of mathematics which says nothing, means nothing. For De Morgan, these were "sentences" which say something:

$$\begin{aligned} 2 + 7 &= 9 \\ 1 + 8 + 4 - 6 &= 4 + 2 + 1 \end{aligned}$$

Very simple sentences don't say much. But even at a simple level, the **meaning** of arithmetic is important.  $4 \times 7$  is not  $7 \times 4$ . The first is "four taken seven times" and the second is "seven taken four times." If you were told to take four pills, seven times a day and instead took seven pills, four times a day, you might find yourself well and truly down the rabbit-hole. On the other hand, the **sense** of both is the same: 28.

I will admit that the two "x taken y times" are arbitrarily chosen. You could assign them either way. De Morgan's time assigned them in the fashion given above. But when we use mathematics to express more than itself, we make these choices and our choices have significance. And consequences.

There are choices of sense as well as of meaning.

Consider multiplication by zero. What should anything multiplied by nothing be? If I multiply 3 apples by 0, don't I still have three apples? Why is  $3 \times 0 = 0$ ? It was a choice. We already had  $3 \times 1 = 3$ . So  $3 \times 0 = 3$  would break the idea that for any number n,  $3 \times n =$  some one and only one particular number. Zero came late to the party from India and  $3 \times 0 = 0$  completed the idea of multiplication for the new zero. In this way it shares the above meaning of multiplication:

$$\begin{aligned} 3 \times 0 & \text{ three taken zero times} \\ 0 \times 3 & \text{ zero taken three times} \end{aligned}$$



Both have the same sense: 0. And if you take something 0 times, you didn't take it, did you?

Negative numbers are another choice. There are no negative quantities: no negative dollars, apples, or time intervals. With quantities or **magnitudes**: if A is greater than B ( $A > B$ ), then taking A from B ( $B - A$ ) is nonsense.

To see the truth of this, let us imagine that you are a criminal selling something illegal and that you owe your supplier \$10,000. Unfortunately, you only have \$3000. When your supplier (also a criminal) shows up for his money, he does not take \$10,000 leaving you with negative \$7000. He takes all you have -- \$3000 -- and gives you a compelling reason to come up with the other \$7000 so fast that you may have to do new and exciting criminal things in order to stay alive.

But if we designate a direction from a point, in any sense, as positive, the opposite direction is negative. Then negative time intervals refer to past time, negative dollars to debt. Note that in the world, the past hours are still positive hours with sixty positive minutes and the negative dollars are still exactly the dollars found in your paycheck, only now they belong to someone else as soon as you get them.

These representations of direction are again a choice which gives the ideas of "negative," "less than zero," and "-3" a sense in mathematics and a meaning in the measurement of time and bank accounts.

Another interpretation De Morgan gives of negative numbers is this, assuming  $a > b$ :

$$\begin{aligned} a - b &= c & b - a &= c \\ 8 - 5 &= 3 & 5 - 8 &= -3 \\ 8 > 5 &\text{ by } 3 & 5 < 8 &\text{ by } 3 \\ a > b &\text{ by } c & b < a &\text{ by } c \end{aligned}$$

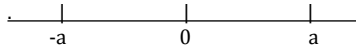

The sense of **-a** is usually taken from the number line. From the origin (or zero point) the distance to some number **a** to the right is **a** and the same distance **a** to the left of the origin is **-a**. This means that

$$\begin{aligned} a - (-b) &= a + b \\ \text{or (a minus b in opposite direction from origin)} \\ &= \text{(a plus opposite direction of b in opposite direction from origin)} \\ &= \text{(a plus b)} \end{aligned}$$

which is confusing in prose but makes perfect sense if you draw a quick number line with an **a**, **b**, and their respective negatives. *Mathematics is the science of diagrams.* Get used to drawing them.

It took mathematicians decades, at least, to come to this choice of negation as direction. They were still sorting it out when De Morgan was writing his first Element books. The point is, that by interpreting negative numbers as directional, the operations of arithmetic could be consistently extended. And this kind of extension always enlarges mathematics.

If the sense of negation by direction had been inconsistent, negative numbers would have been excluded from mathematics. As it is, any contradiction, such as negative, non-existent apples is in your own misunderstanding alone and neither in mathematics nor in

the use of mathematics to represent the world.

If you understand this interpretation of negatives, you can see that:

$$\begin{aligned}(a - c) + (b + c) &= a + b \\(a + c) - (b + c) &= a - b \\(a - c) - (b - c) &= a - b\end{aligned}$$

And if you can't simply see this, work on it until you can. The point of grasping the core of mathematics is to clearly see things which are equivalent, yet different, forms of the same essence. You have to begin with very simple forms in this way if you are ever to grasp more complicated forms as equivalent. The real power of mathematics is to recognize and interchangeably use equivalent forms in a meaningful way.

Before we go on, let's clarify that parentheses or "parens" as used above **unify** what they contain:

$a - (b + c) = a - b - c$  Here we subtract all of  $b$  and all of  $c$  from  $a$  because the parens force the addition, creating a unified number to subtract from  $a$ .

$a - (b - c) = a - b + c$  Here we are only subtracting the excess of  $b$  over  $c$  because the parens initially force their subtraction.

To see this idea of unity clearly, consider:

$$\begin{array}{ll}1 + (2 + 3)(4 + 5) & a + (b + c)(d + e) \\1 + 5 \cdot 9 & a + (bd + be + cd + ce) \\1 + 45 & a + bd + be + cd + ce \\46 & \end{array}$$

On the left, we unify what is in the parens, first within the parens and then without. Then we add 1 for the result. In algebra, we have nothing more than the Distributive Law to unify what is in the parens. Then because it is all addition, we can drop the parens due to the Associative Law. In the right hand side, we have three expressions ( $a$ ,  $b+c$ ,  $d+e$ ) which make up a single number ( $a + (b + c)(d + e)$ ) which we expand into its simplest general form ( $a + bd + be + cd + ce$ ). The parens stay in place until the final single, unified number is reached.

With only your basic arithmetic and your knowledge of our positional decimal system, you should easily see:

$$\begin{aligned}156 \times 29 &= 100 \times 29 + 50 \times 29 + 6 \times 29 \\156 \times 29 &= 156 \times 18 + 156 \times 6 + 156 \times 5\end{aligned}$$

And you should easily discern which of these is true and which false:

$$\begin{aligned}156/12 &= 72/12 + 60/12 + 24/12 \\156/12 &= 156/3 + 156/4 + 156/5\end{aligned}$$

It is important to realize that our positional decimal notation is a choice and one governed by convenience. It was made possible by our accepting zero as a symbol for "nothing." Where the Romans would use MXLI, which has to be deciphered according to rules, we can express the same idea using 1041. This shows itself to contain one thousand, no hundreds, four tens, and one unit -- the zero serving as a placeholder. Positional notation is possible for any **base**. We use a decimal base or base 10. From right to left, our decimal positions are ones, tens, ten times tens, ten times ten times tens, and so on. Any other

number can be used as a base instead of ten. In base 6, the digits are 0 - 5, six is written 10, positions are ones, sixes, six times sixes, etc. And everything else works just like ours does but in a sixty way.

Another value of a positional system is that it allows the use of memorized tables of addition and multiplication to add, subtract, multiply, and divide -- all using the simple algorithms taught in elementary school. Other algorithms are possible, sometimes quicker in use, but not simple enough for children to grasp.

Consider this algorithm of subtraction:

$$\begin{array}{r} 8927862 \\ - 7184863 \\ \hline 1742999 \end{array}$$

We will subtract from left to right. For any column, if the column to the right is a lesser number over a greater, increase the current lower quantity by one. If the column to the right has equal numbers, skip it and go on until one has unequal numbers and do as above. Then subtract lower from upper, adding ten to the upper if necessary. Here we go, using "∴" as "therefore."

- Col 1: 8 over 7. Next col:  $9 > 1 ∴ 8 - 7 = 1$
- Col 2: 9 over 1. Next col:  $2 < 8 ∴ 9 - 2 = 7$
- Col 3: 2 over 8. Next col:  $7 > 4 ∴ 12 - 8 = 4$
- Col 4: 7 over 4. Next unequal col:  $2 < 3 ∴ 7 - 5 = 2$
- Col 5: 8 over 8. Next unequal col:  $2 < 3 ∴ 18 - 9 = 9$
- Col 6: 6 over 6. Next col  $2 < 3 ∴ 16 - 7 = 9$
- Col 7: 2 over 3. No next col  $∴ 12 - 3 = 9$

If you think you understand this method, write out a similar problem and test your ability to actually use the method. It is worth learning as it is much faster than our public school algorithm.

In positional notation, we have one and only one unit (1) and multiples of this unit. So we can ignore any "types" of unit (apples, miles, acres) and treat them all the same. We only need the number of symbols (0 - 9) indicated by the base (10). For names, we only need one per symbol plus one per self-multiple or **power** of the base (ten, hundred, ...). And we can group everything by the number of the base: tens. In any earlier non-positional system, any of the above can be much more complicated.

In what follows, we will sometimes consider number in general. But as De Morgan said, the student *does not, and cannot, generalise at all; he must be taught to do so*. This is to say that, until you actually and naturally and correctly generalize, you don't. And you can't, until you know the rules.

And while women were not allowed to play this game in 1830, "he" is now also "she," as intelligence has nothing to do with gender. It has only to do with what kind of a mind you develop for yourself. And most people, if they develop one at all, try to make it an ersatz simulation of someone else's mind in order to conform to society and gain other people's approval. And this is not intelligence, even if it lands you a professorship. Intelligent people have their own minds which conform only to the right understanding of their own individuality.

But we were talking about number in general or using letters as numbers. In this section of Arithmetic, numbers as letters are not really algebra. They are the baby-beginning of doing arithmetic with letters. And you are not a baby. So I know you can handle it.

Consider:

$$\frac{aa - 1}{a - 1} = a + 1$$

The "aa", or "a×a", is usually written "a<sup>2</sup>" where the **exponent** 2 simply counts the "a's". And don't make exponents any harder than counting the letters:

$$4a^3b^2 = aaabb + aaabb + aaabb + aaabb$$

and a<sup>3</sup>b<sup>2</sup> or aaabb only means a×a×a×b×b. At each point, grasp the **simple** meaning of each idea and then go on to the development of those ideas.

If we multiply both sides of the above equation by "(a - 1)" we get:

$$a^2 - 1 = (a + 1)(a - 1)$$

or "a-squared minus one equals a plus one times a minus one." This is number in general because if it is true (and it is), it is true for any a (or "∀a").

"∀" means "each, every, any, all" which are all equivalent ("≡") logically. We use symbols everywhere we can because we are very lazy. "∀" is quicker to write than "every" and "≡" is way shorter than "equivalent." Most importantly, symbols have the advantage of being completely unambiguous. They mean exactly what we decide they are to mean and nothing else.

So if a = 3 then

$$\begin{aligned} 3^2 - 1 &= (3 + 1)(3 - 1) \\ 9 - 1 &= 4 \times 2 \\ 8 &= 8 \end{aligned}$$

or if a = 13 then

$$\begin{aligned} 13^2 - 1 &= (13 + 1)(13 - 1) \\ 169 - 1 &= 14 \times 12 \\ 168 &= 168 \end{aligned}$$

and clearly this is also true:

$$\frac{a^2 - 1}{a + 1} = a - 1$$

Even in this simple form, algebra allows us to state things generally. Consider this proposition: Given two numbers, half their sum and half their difference equals the greater number. We can **experiment** with this idea using any actual numbers:

$$\frac{16 + 10}{2} + \frac{16 - 10}{2} = 16 \qquad \frac{27 + 8}{2} + \frac{27 - 8}{2} = 27$$

From our experiment, the proposition appears likely to be true in general. But we can't establish generality **with** numbers. Algebra lets letters stand for any numbers, all at once. Here "∀a,b ∈ **N**: a > b" is laziness for "any a and b in the natural numbers: 1, 2, 3, ..., such that a is greater than b."

$$\forall a,b \in \mathbf{N}: a > b \text{ then } \frac{a+b}{2} + \frac{a-b}{2} = \frac{a+b+a-b}{2} = \frac{2a}{2} = a$$

In this way, the general truth is established. Let's be clear about baby algebra notation:

1. A letter stands for any number. If the letters are different, the numbers can be different. Or not.
2. Addition (+) and subtraction (-) are identically notated as in arithmetic.
3. Multiplication of a and b can be denoted as  $a \times b$  or  $a \cdot b$  or, most usually, simply  $ab$ . You only need an operator when absolutely necessary, as in:  $7 \cdot 6ab \neq 76ab$ .
4. Division of a by b can be  $a \div b$  or  $a/b$  just as in arithmetic.
5. For inequalities, if a is greater than b, we have  $a > b$  or  $b < a$ . If b is greater than a:  $a < b$  or  $b > a$ .
6. Exponents are syntactic candy which allow us to write  $a^2$  instead of  $a \times a$  or  $7^5$  instead of  $7 \times 7 \times 7 \times 7 \times 7$ . Later we will see exponents have an arithmetic.

All our "algebra" at this point is **only** baby arithmetic with letters. You know arithmetic (or you should bail out now) and you know letters (or you can't read this). So you know **everything** there is to know about this baby algebra. **Do not even begin to think there is more to it than this.** It's arithmetic and letters and that's all. Algebra is much, much more.

The most common mistake in learning mathematics is to convince yourself that you are in an immense and dreadful darkness, full of things you don't understand. The truth is, that at every point, you have all the ideas you need. When you understand them in their **simplicity**, you understand everything there is **up to that point**. The second most common mistake is to fall behind by not making the effort to **understand every simple thing up to each point**. If you have already fallen behind, go back and catch up.

Our course of development -- which leads to our actually having a mind -- is simply to understand each simple idea and its use as we go along. A quick summary before we go on to addition:

expression	operator	operation	verb	result
$a + b$	+	addition	a plus b	sum
$a - b$	-	subtraction	a minus b	difference
$a \times b$	$\times$	multiplication	a times b	product
$a \div b$	$\div$	division	a divided by b	quotient

If we let a and b be any numbers, the above is our truth-grounds. And their basic consequences make up the rest of this book.

## Addition

There is a difference between knowing how to add and understanding what you are doing with addition. Part of the understanding is general. We know that if we can put numbers together, we can take them apart:

$$\forall a \in \mathbf{N} \text{ if } a \geq 3 \text{ then } \exists b, c, d \in \mathbf{N}: a = b + c + d$$

In plain English: For any number  $a$  in the set of **natural numbers**  $\{1, 2, 3, \dots\} \equiv \mathbf{N}$ , if  $a$  is greater than or equal to three then there exists some  $b$ ,  $c$ , and  $d$  in  $\mathbf{N}$  such that  $a$  equals  $b$  plus  $c$  plus  $d$ .

Clearly,  $b$ ,  $c$ , and  $d$  don't have to be different. They just have to exist. Given the above:

$$\begin{aligned} a &= b + c + d \\ \therefore 2a &= 2b + 2c + 2d = 2(b + c + d) \\ \text{and } a - e &= b + c + d - e \\ &= (b - e) + (c + d) \\ &= (c - e) + (b + d) \\ &= (d - e) + (b + c) \end{aligned}$$

All of which should appear simple and almost self-evident. But from simple numbers on up, you should be able to take them apart and manipulate them like this and see these relations without having to work at it. You should see what's there and also see what **principled** things you can do with what's there. All of mathematics is principled, governed by the laws we are led to from the truth grounds.

Here is all you need to know about adding algebraic expressions:

**If the letter things are the same you can add them together.**

If we have 4 little  $a^2b^3$ 's and 6 more little  $a^2b^3$ 's then we have 10 of them altogether or:

$$4a^2b^3 + 6a^2b^3 = 10a^2b^3$$

And no matter how complicated the algebraic expressions get, addition never gets any harder than this. We call terms like  $4a^2b^3$  and  $6a^2b^3$  **homogeneous** when the letter bits are the same. You can add (or subtract) homogeneous terms. You cannot add anything else. Do not lose your mind and write something like:

$$6a^2b^3 + 3a^3b^2 = 9a^5b^5$$

Because adding non-homogeneous terms in **any** way is nonsense.

This breaking up of some  $n \in \mathbf{N}$  into a sum of pieces makes it easy to prove the Commutative Law of Addition, at least to yourself. For any two natural numbers, say 3 and 4, we have:

$$\begin{aligned} 3 + 4 &= (1 + 1 + 1) + (1 + 1 + 1 + 1) \\ &= 1 + 1 + 1 + 1 + 1 + 1 + 1 \\ &= (1 + 1 + 1 + 1) + (1 + 1 + 1) = 4 + 3 \end{aligned}$$

We can use this breaking up of numbers to come to a real understanding of what goes on when we "carry" in our elementary school addition algorithm. When you add 1834 and 2799 (Well, do it right quick, add them on paper, carrying the whatnots...), this is what goes on:

$$\begin{array}{r}
 1834 = 1000 + 800 + 30 + 4 \\
 2799 = \underline{2000} + \underline{700} + \underline{90} + \underline{9} \\
 (+) \quad 3000 \quad 1500 \quad 120 \quad 13 \quad \text{1st carry will clear the units} \\
 \quad \quad 3000 \quad 1500 \quad 130 \quad 3 \quad \text{2d carry will clear the tens} \\
 \quad \quad \quad 3000 \quad 1600 \quad 30 \quad 3 \quad \text{3d carry will clear the hundreds} \\
 \quad \quad \quad \quad 4000 \quad 600 \quad 30 \quad 3 \quad \text{which gives the answer} \\
 \quad \quad \quad \quad \quad 4633
 \end{array}$$

By "clear" we mean "get rid of what does not belong in that column." In the first "carry," we move ten ones to the tens column, as a single ten, where they belong. 13 goes to 3, which leaves only ones. And 120 gets the ten making it 130 and still has one ten-times-ten that doesn't belong. You can see that our positional notation means we don't have to write all these zeroes, as each position implies its exact number of zeroes. Just as in our alternate subtraction algorithm, addition, too, works in either direction:

$$\begin{array}{r}
 1834 \\
 \underline{2799} \\
 13 \\
 12 \\
 15 \\
 3 \\
 \hline
 4633
 \end{array}
 \qquad
 \begin{array}{r}
 1834 \\
 \underline{2799} \\
 3 \\
 15 \\
 12 \\
 \underline{13} \\
 4633
 \end{array}$$

This technique can be useful in developing your mind. But first, a brief note on calculators:

People who use calculators do not develop a mind. And if you don't develop your mind on simple arithmetic, good luck when you come to second order tensors or even simple Calculus. Using a calculator is like buying a membership at the gym and then paying someone else to lift weights for you. No matter how much you pay them, you remain a complete and total loser. Not that calculators don't have their place in mathematics. But their place is not to secure your stupidity against all progress. End of brief note.

**Start doing all simple arithmetic in your head.** Consider:

$$\begin{array}{r}
 68 \\
 +74 \\
 130 \\
 \underline{12} \\
 142
 \end{array}$$

Let's distinguish, artificially, mental functions of "seeing" and "thinking." The first happens without saying something silently to yourself. The second, you say it silently to yourself. To add 68 and 74, think 130, see 12, add and think 142. Seeing and thinking doesn't matter so much here. But as it gets complicated, thinking when you should be quietly seeing will mess you up. Seeing is a kind of saying, if you observe it in action, but thinking is a more emphatic saying that repeats what seeing lightly said. That's my experience of it. The point is that what we are calling thinking persists in memory while seeing slips away and leaves the mind uncluttered after we have used what we saw. Now try these in your head and then make up some for yourself next time you have to sit and wait for something.

$$\begin{array}{r} 689 \\ +743 \\ \hline \end{array}$$

$$\begin{array}{r} 68 \\ 74 \\ +93 \\ \hline \end{array}$$

If you will practice this a bit, you will find yourself solving simple problems in your head, even as you are picking up your calculator. Do this a couple times and you skip picking up the calculator.



## Subtraction

Just as there is not much to say about addition, there is not a lot to say about subtraction. In these early parts of our course of development, we are mainly nailing down the details of our existent understanding of these simple ideas. Make sure you nail them down.

Let's go back to the Commutative Law:  $a + b = b + a$ . It is clear that

$$4 - 3 \neq 3 - 4$$

We need addition here, not subtraction:

$$\begin{aligned} 4 + (-3) &= (-3) + 4 \\ \therefore 4 + (-3) &= 1 + 1 + 1 + 1 + (-1) + (-1) + (-1) \\ &= (-1) + (-1) + (-1) + 1 + 1 + 1 + 1 = (-3) + 4 \end{aligned}$$

We see that the units, all positive in addition or positive and negative in subtraction, are persistent ideas in themselves and can be rearranged in any order:

$$4 + (-3) = 2 + (-1) + 2 + (-2) = 1 + (-2) + 3 + (-1) = \dots$$

The Commutative Law is a by-product of this persistence allowing us to rearrange any  $a + b$  into  $b + a$ . With these ideas, complete and consistent, we have another set of numbers to think about. We began with the natural numbers:

$$\mathbf{N} \equiv \{1, 2, 3, \dots\}$$

And we **extend** this set and its related ideas to the set of **integers**:

$$\mathbf{Z} \equiv \{\dots -3, -2, -1, 0, 1, 2, 3, \dots\} \equiv \{0, n, -n \forall n \in \mathbf{N}\}$$

You can read this second definition as "the set of zero plus  $n$  and  $-n$  for every  $n$  in  $\mathbf{N}$ ". If we were being tedious, we could say there is no subtraction, there is only addition, and then turn every " $a - b$ " into " $a + (-b)$ ". Let's not do that, no matter how formally true it is.

In a very real sense, with  $\mathbf{N}$  we have **only** positive magnitudes and a subtraction that gives us nonsensical negative apples if we aren't careful. Then  $\mathbf{Z}$  gives us a zero and labels, based on  $\mathbf{N}$ , for a number line and subtraction becomes addition, using any set of negative and positive elements, as defined by a **sense** of direction. Negative apples remain nonsense.

If you will completely grasp the simple truth of all this, you will save yourself a lot of trouble down the line. Every **extension** of mathematics brings with it almost all of the old ideas, where they have a new extended **sense** in an expanded framework of thought. And anything that was truly nonsense before remains nonsense. We in no way ever affirm or require negative apples or any other determinate quantity less than zero, as such a thing cannot exist.

Also, do not get caught up in the idea of "sets," such as the set of all natural numbers or the set of integers. There is a "Set Theory" which was all the rage in the 1930s and is still around in various forms. But if you're not going for a degree in mathematics, a set is **only** a bunch of things that meet a defined criterion, like  $\mathbf{N}$  or  $\mathbf{Z}$ . With a degree, there are more

details but the sets are the same. For as far as this text will take you, there is nothing complicated about a set. It's just a bag with a certain kind of stuff in it.

At this point, subtraction amounts to little more than this:

$$\begin{aligned}\forall a, b, c \in \mathbf{Z}: \quad a - b &= (a + c) - (b + c) = a + c - b - c \\ &= a - b + c - c = a - b \\ a - b &= (a - c) - (b - c) = a - c - b + c \\ &= a - b + c - c = a - b\end{aligned}$$

Why do we consider obvious things like this? Because they are not essentially obvious. Initially, a child-like mind understands them not at all. As the mind progresses, the ideas become clearer and clearer. Eventually, there is no shadow of doubt left in one's understanding. You want to study each idea presented to you until **no** shadow remains. This means that each sentence, in De Morgan's sense of sentences, must clearly say to you what it says. Each portion of each idea must clearly have its **sense** within the only mind you will ever develop.

In algebra, subtraction is just like addition. So in our baby algebra

$$\begin{aligned}9a - 7a &= 2a \\ 8x^2/y + ax^2/y &= (a + 8)x^2/y\end{aligned}$$

because these terms are homogeneous. But anything resembling

$$6a^3 - 4a^2 = 2a \quad \text{or} \quad 6a + 4b = 10(a+b)$$

is nonsense. Add or subtract **only homogeneous terms**.

The following is an exercise for that mind you are working on. It shows the subtraction of 39628 from 61274. And it combines the method of the elementary school's right to left subtraction with an element of our above left-to-right example. The point of this is **not** whether or not you understand the answer to be 21646. The point is whether or not you follow the workings of this method.

Recall that  $a \times a$  is  $a^2$  and therefore  $10^4 = 10 \times 10 \times 10 \times 10$ . And just as  $3 \times 0$  was chosen, for excellent reasons, to be equal to 0, anything  $(10)$  to the zero-power  $(10^0)$  has been chosen to be equal to 1. Here we go:

$$\begin{aligned}61724 &= 6 \cdot 10^4 + 1 \cdot 10^3 + 2 \cdot 10^2 + 7 \cdot 10^1 + 4 \cdot 10^0 \\ (-) 39628 &= 3 \cdot 10^4 + 9 \cdot 10^3 + 6 \cdot 10^2 + 2 \cdot 10^1 + 8 \cdot 10^0\end{aligned}$$

	a	6	1	2	7	4
	b	3	9	6	2	8
(a + 10)		6	1	2	7	<b>14</b>
(b + 10)		3	9	6	<b>3</b>	<b>8</b>
					4	6
(a + 1000)		6	1	<b>12</b>	7	14
(b + 1000)		3	<b>10</b>	6	3	8
				6	4	6
(a - 10000)	<b>5</b>		1	12	7	14
(b - 10000)	3	<b>0</b>		6	3	8
	2	1	6	4	6	

Now subtract 486904 from 933852 using the above method. The fumbling around you do will show you where the shadows are. When the shadows are gone, you may proceed to the next section. We get rid of shadows by creating examples for ourselves to generate light.

## Multiplication

Simple things first.

$a \times b$	$a, b = 10, 2 \therefore 10 \times 2$
Let $a = c + d + e$	$c, d, e = 5, 3, 2$
$ba = bc + bd + be$	$2 \times 10 = 2 \times 5 + 2 \times 3 + 2 \times 2$
$ba = b(c + d + e)$	$2 \times 10 = 2(5 + 3 + 2)$
$ba = ab$	$2 \times 10 = 2(10) = 20$

That was just the Distributive Law. Again, with new values:

$a = c + d - e$	$10 = 5 + 6 - 1$
$ba = bc + bd - be$	$2 \times 10 = 2 \times 5 + 2 \times 6 - 2 \times 1$
$ba = b(c + d - e)$	$2 \times 10 = 2(5 + 6 - 1)$
$ba = ab$	$2 \times 10 = 2(10) = 20$

All very simple. But no amount of complexity affects the principles involved.

Let  $a = x^2 + 3x + 4$  and  $b = 6y$ :

$$ab = (x^2 + 3x + 4)(6y) = 6x^2y + 18xy + 24y = (6y)(x^2 + 3x + 4) = ba$$

Unlike addition and subtraction, we can multiply non-homogeneous terms:  $x \times y = xy$  but  $x+y$  is in simplest form. And any numerical constants are treated normally in multiplication just as they were in addition:

$$6x \times 2y = 6 \times x \times 2 \times y = 6 \times 2 \times x \times y = 12 \times xy = 12xy$$

Of course,  $12xy = x12y = yx12 = \dots$  but our convention of notation is to start with the constant and add letters in alphabetical order, as in  $12xy$ . Again:

$a = cd$	$10 = 2 \cdot 5$
$ba = bcd$	$3 \cdot 10 = 3 \cdot 2 \cdot 5$
$bcd = dbc = cbd$	$3 \cdot 2 \cdot 5 = 5 \cdot 3 \cdot 2 = 2 \cdot 3 \cdot 5$

Complexity of form would not effect this simplicity either. It simply requires more attention on your part. Before we look at our elementary school algorithm, a few definitions:

$a \cdot b = c$	$5 \cdot 4 = 20$
$a$ taken $b$ times equals $c$	$5$ taken $4$ times equals $20$
$a \equiv$ multiplicand	$5 \equiv$ multiplicand
$b \equiv$ multiplier	$4 \equiv$ multiplier
$c \equiv$ product	$20 \equiv$ product
$a$	$5$
$\times b$	$\times 4$
$c$	$20$

Also, note that in our positional decimal notation, anything (3) multiplied by a power of the base ( $10^n$ ) is simply **shifted**  $n$  positions and zeroes are added as placeholders:

$$3 \times 10 = 3 \times 10^1 = 30 \quad (\text{3 shifted one place to the left})$$

$$3 \times 100 = 3 \times 10^2 = 300 \quad (\text{here shifted 2 places})$$

Later we will see that -n shifts in the opposite direction.

I know that mathematicians often assume the reader understands something when the reader can't yet understand. But when I said, "by a power of the base ( $10^n$ )," I know that I mentioned that our positional decimal notation is base 10. I pointed out that  $a^2 = a \times a$  and that the 2 comes from counting the a's. And we have defined "power" on a couple occasions. So all I am assuming is that you make the leap from  $a^2$  being the product of 2 a's to  $10^n$  being the product of n tens. And you can do this.

To do well in mathematics, you have to grasp simple definitions like these so that you can simply use them as needed. In mathematics, you need the basics all the time. Good mathematicians do this naturally. Further, they easily grasp the simple sense of things. And this comes, in a way, from having somewhat narrow or simplistic minds. Such people often do not see the possible ambiguities in mathematical explanations, even their own, where broader and less simplistic minds are disconcerted by those ambiguities.

None of this is a criticism of anyone's mind. It is simply the reality of things. Sometimes you do not grasp mathematics because you are not paying sufficient attention. But sometimes you do not grasp it because you are not seeing it simply enough. If you have a broader mind, you must discipline it so that it does not introduce extraneous ideas into mathematics. And if you have a more narrow mind, do not go out of your way to prevent its growth.

When we multiply, as in  $1368 \times 8$ , we are doing this in our positional notation:

$$1368 = 1000 + 300 + 60 + 8$$

$$8 \times 1368 = 8000 + 2400 + 480 + 64 = 10944$$

Our elementary school algorithm is a simplification of this:

$\begin{array}{r} 1368 \\ \times 8 \\ \hline 64 \\ 480 \\ 2400 \\ 8000 \\ \hline 10944 \end{array}$	<p>But in our algorithm, we are taught not to write each multiplication on one line. We "carry" values along the top as with addition. This keeping the product of each digit of the multiplier on one line allows larger multipliers to be easily handled:</p> $\begin{array}{r} 1368 \\ \times 28 \\ \hline 10944 \\ 2736 \\ \hline 38304 \end{array}$
<p>*In the 208, note how the 0 can be handled using that <b>shift</b> above.</p>	$\begin{array}{r} 1368 \\ \times 208 \\ \hline 10944 \\ 2736 \quad * \\ \hline 284544 \end{array}$

To shorten our description of equations, we use LHS and RHS like this: in  $a + b = c$ , the left-hand side (LHS) is  $a + b$  and the right-hand side (RHS) is  $c$ . Some more thoughts on multiplying numbers generally:

$$6a^3b^4c \times 12a^2b^3c^3d =$$

$$6aaabbbbc \times 12aabbbcccd =$$

$$6 \cdot 12 \cdot aaaaa \cdot bbbbbb \cdot cccc \cdot d =$$

$$72a^5b^7c^4d$$

We can use the Distributive Law for any number of elements:

$$a(b + c - d) = ab + ac - ad$$

But the LHS here was already simpler. We generally simplify like this

$$ac + ad + bc + bd = a(c + d) + b(c + d) = (a + b)(c + d)$$

where the result is clearly simpler. Commonest forms:

$$\begin{aligned} a \times a &= a^2 & a \times b &= ab & & \text{( RHS only form we use of either )} \\ a(b + c) &= ab + ac & & & & \text{( LHS considered simpler )} \\ (a + b)(c + d) &= ac + ad + bc + bd & & & & \text{( Distributive Law used twice )} \\ (a - b)(c + d) &= ac + ad - bc - bd \\ (a - b)(c - d) &= ac - ad - bc + bd \\ (a + b)(a + b) &= aa + ab + ba + bb = a^2 + 2ab + b^2 = (a + b)^2 \\ (a - b)(a - b) &= aa - ab - ba + bb = a^2 - 2ab + b^2 = (a - b)^2 \\ (a + b)(a - b) &= aa - ab + ba - bb = a^2 - b^2 \end{aligned}$$

With negative number in multiplication, consistency in mathematics requires:

$$\begin{aligned} +a \cdot +b &= ab & +a \cdot -b &= -ab \\ -a \cdot +b &= -ab & -a \cdot -b &= ab \end{aligned}$$

You can see this in the above examples. In all of these,  $-x = -1 \cdot x$  and  $x = 1 \cdot x$ . (Here we use  $x$  to talk about  $a$  and  $b$  in general terms.) So  $1 \cdot 1 = 1$ ,  $-1 \cdot 1 = 1 \cdot -1 = -1$  and  $-1 \cdot -1 = 1$ . You cannot **prove** these results. But mathematicians came to this agreement because any other interpretation creates a train wreck.

Here is an important pattern that arises as a form of number:

$$\begin{aligned} (a+b)^2 &= a^2 + 2ab + b^2 \\ (a+b+c)^2 &= a^2 + 2ab + 2ac + b^2 + 2bc + c^2 \\ (a+b+c+d)^2 &= a^2 + 2ab + 2ac + 2ad + b^2 + 2bc + 2bd + c^2 + 2cd + d^2 \end{aligned}$$

I know that you can see the pattern here. So I know that you can determine the expansion of  $(a+b+c+d+e)^2$  without having to multiply it out and without needing anyone to tell you that it is correct. Maybe you should go do that right quick.

Here is another important form of number:

$$\begin{aligned} (a + b)^1 &= a + b \\ (a + b)^2 &= a^2 + 2ab + b^2 \\ (a + b)^3 &= a^3 + 3a^2b + 3ab^2 + b^3 \\ (a + b)^4 &= a^4 + 4a^3b + 6a^2b^2 + 4ab^3 + b^4 \end{aligned}$$

You can easily see that some pattern arises in the exponents of  $a$  and  $b$ . The pattern in the coefficients (constants preceding letters in the terms) is not obvious but if you look at the numbers alone and how they relate to the previous line, you will probably see it:

$$\begin{array}{cccc} 1 & & & \\ 1 & 2 & & \\ 1 & 3 & 3 & \\ 1 & 4 & 6 & 4 & 1 \end{array}$$

This is Pascal's Triangle and its law is called the Binomial Theorem.

Consider  $a^2 - b^2 = (a + b)(a - b)$ . One form this takes is the sum and difference of two numbers. And their product is the difference of their squares. If  $a > b$ , you can interpret this as the sum and difference of two lines. But you can't have Euclidean negative lines -- how would you draw them. (In other geometries, there **are** positive and negative lines.) The Euclidean rectangle of the sum and difference equals the square on the greater line minus the square on the lesser. And because this relation is true for all values, we can substitute any expression for  $a$  or  $b$ .

$$\begin{array}{lll} a = p + q & \therefore (p + q)^2 - b^2 & = (p + q + b)(p + q - b) \\ a = c^2, b = d^2 & \therefore c^4 - d^4 & = (c^2 + d^2)(c^2 - d^2) \end{array}$$

But we didn't need substitution for that last one. If  $a^2 - b^2 = (a + b)(a - b)$  then:

$$\begin{array}{l} a^4 - b^4 = (a^2 + b^2)(a^2 - b^2) \text{ and} \\ a^6 - b^6 = (a^3 + b^3)(a^3 - b^3) \text{ and so on.} \end{array}$$

We generally substitute or make these changes for a reason. Different reasons can be used to choose the final form:

$$(b + m)^2 - b^2 = (b + m + b)(b + m - b) = (2b + m)m$$

Here is an application of the form  $(a + b)^2$  which you can use to square two-digit numbers in your head. Take 24. This equals  $20 + 4$  or  $(20 + 4)$ . Look familiar?

$$\begin{array}{l} \text{Now consider } (20 + 4)^2 = 20^2 + 2 \cdot 20 \cdot 4 + 4^2. \\ \text{This is simply } (a+b)^2 = a^2 + 2ab + b^2. \end{array}$$

The easiest way for me to do the squaring is to think the first square (400), see the  $2ab$  as a product (160), think their sum (560), see the second square (16) and add it in (576). Or see the two squares (400 and 16), think the sum (416) and add the  $2ab$  ( $416 + 160 = 576$ ).

And this brings up another pattern of number:

if we square	number of digits
1 - 9	1 or 2
10 - 99	3 or 4
100 - 999	5 or 6

and so on. If you play with some numbers on paper, you will quickly understand the part played here by powers of 10.

But if you consider each line of this pattern, what can you say about the point where the digits go from some  $n$  to  $n+1$  digits as in  $3^2$  (1 digit) and  $4^2$  (2 digits) in the first line? How much of a pattern can you discern? How good a predictor of the break in the next line can you make the break in a current line?

Let us consider one more basic multiplication before we go on to division. We multiply  $7x^3 + 4x^2 + 3x + 1$  and  $2x^3 - 3x + 2$ . In school, we are taught to do this using the Distributive Law with Long Multiplication but there is an easier way. Think of the  $x$ 's as  $10^n$  instead of  $x^n$ . Then leave out the  $x$ 's and use our elementary method:

[Cont'd next page.]





## Division

De Morgan points out that multiplication is multiple-addition and that division is multiple-subtraction. This is an older, but valid, view of these concepts.

$20 \div 5 = 4$	$21 \div 5 = 4 \text{ r } 1$ (remainder 1)
$20 \equiv \text{dividend}$	$21 \equiv \text{dividend}$
$5 \equiv \text{divisor}$	$5 \equiv \text{divisor}$
$4 \equiv \text{quotient}$	$4 \equiv \text{quotient}$
No remainder	$1 \equiv \text{remainder}$

5 can be subtracted from 20 4 times with no remainder and from 21 4 times with a remainder of 1. We write  $21 \div 4 = 5 \text{ r } 1$  in another way in our elementary school algorithm:

$$\begin{array}{r} 5) 21 \text{ (4 r1)} \\ \underline{20} \\ 1 \end{array}$$

If we speak of this in general terms:

$$a \div b = c \text{ r } d \quad \text{or} \quad a = bc + d$$

If there is no remainder,  $a \div b = c$  or  $a/b = c$  or  $a:b = c$

This last notation is from Euclid's proportions and ratios. It is simply another equivalent notation if viewed this way. As in the other three operations using positional notation, what works on the whole with division, works on the parts:

$$\begin{aligned} a &= b + c + d \\ 156 &= 91 + 39 + 26 \\ (156/13 = 12) &= (91/13 = 7 \quad 39/13 = 3 \quad 26/13 = 2) \\ 12 &= 7 + 3 + 2 = 12 \end{aligned}$$

$$\begin{aligned} 156 &= 100 + 50 + 6 \\ (156/13 = 12) &= (100/13 = 7\text{r}9 \quad 50/13 = 3\text{r}11 \quad 6/13 = 0\text{r}6) \\ 12 &= 7 + 9/13 + 3 + 11/13 + 0 + 6/13 = 10 + 26/13 = 10 + 2 = 12 \end{aligned}$$

This second example can be used to show how our positional decimal notation handles division. And our elementary school algorithm simplifies it:

13) 156 (12	13 goes into 15 once, remainder 2
<u>13</u>	The 6 is brought down to the 2
26	13 goes into 26 twice
<u>26</u>	

But the once in line 1 is a ten    13) 156 (10 + 2 = 12

$$\begin{array}{r} 10 \cdot 13 = 130 \\ \text{Remainder 26 and the twice is 2} \\ 2 \cdot 13 = 26 \text{ remainder 0} \end{array} \quad \begin{array}{r} \underline{130} \\ 26 \\ \underline{26} \end{array}$$

If you will think about this, you can see that our algorithm uses placement on the page to take advantage of positional notation. We can divide the optimum number of digits in the dividend for whatever divisor. And we don't have to track a bunch of zeroes.

Here's what I mean by zeroes:

1342)	36326599 (20000 <u>26840000</u> 9486599 (7000 <u>9394000</u> 92599 (60 <u>80520</u> 10279 (9 <u>10278</u> 1		1342·20,000  1342·7,000  1342·60  1342·9 27069 r 1
	or		

Before we use the same numbers to show what our algorithm actually does, make sure that you are following the meaning of every one of these examples. If there is any doubt in your mind, root it out. No one else can. Our course of development, the goal of which is to create a mind, requires our own mental effort. As we come to each idea, make it crystal clear in your mind. Allow yourself no mental laziness. Permit no shadow of doubt to remain in your mind. Or the darkness will accumulate and block out the light.

Here's our elementary school algorithm, same data:

	1342) 36326599 (27069 <u>2684</u> 9486 <u>9394</u> 9259 <u>8052</u> 10279 <u>10278</u> 1		(notation allows dropping 0s) r 948 (pull down 1 digit: 6) 1 - 1: no zeroes added to quotient r 92 (pull down 2: 59) 2 - 1: add zero to quotient r 1027 (pull down 1 digit: 9) 1 - 1: no zeroes to quotient r 1
--	--	--	--

We pull down the digits we need to make each dividend big enough for the divisor. We pull down n digits and add n-1 zeroes to our quotient. (Exercise: Why?) Now you can clearly see that our elementary school algorithm uses positional notation to (1) hide all the details; and (2) handle all the difficulties.

Let's make another mental effort. The properties of number, for you, are limited to those in the only mind you are developing. So let's divide a big number (132976) by a small number (4) in our head. Doing this, we would write down the answer as we go:

$$4 \ ) \ 132976 \ ( \ 33244$$

1.  $13/4 = 3 \text{ r}1$  The 1 makes the 2 a 12
2.  $12/4 = 3$
3.  $9/4 = 2 \text{ r}1$  The 1 makes the 7 a 17
4.  $17/4 = 4 \text{ r}1$  The 1 makes the 6 a 16
5.  $16/4 = 4$

The tendency of the finite mind, the mind we get for free, is to slide over everything that requires effort and to stop and linger over fears or, when no fears intervene, desires. When the mathematician George Hardy said most people never do anything well, this is the same as saying, most people settle for the mind they get for free. And it cannot do anything well. You have to develop it.

To develop a mind which is expansive, unbounded, and therefore infinite, one must exercise one's consciousness and develop its powers. Every exercise or activity in this

book for the unaided mind is the practice that develops your ability to **see** the form of number. At first, we calculate to see. But as our powers are developed, we begin to naturally see.

Did your mind balk at the idea of its being infinite? You can have one right idea, two right ideas, three right ideas, and so on. This is precisely the nature of infinity. When will you have your last right idea? When you settle for the limitations of the finite mind.

Let's do a little baby algebra division. Algebraic fractions are not necessarily fractions, and conversely, algebraic non-fractions are not necessarily not fractions, depending on the values they are given.

$$\begin{array}{llll} (a+b)/(a-b) & \text{if } a=12 & b=6 & \text{then } (12+6)/(12-6) = 18/6 = 3 \\ a^2 + 2ab & \text{if } a = 1/2 & b=2 & \text{then } (1/2)^2 + 2 \cdot (1/2) \cdot 2 = 1/4 + 2 = 9/4 \end{array}$$

For algebra to be consistent with numeric arithmetic, we define **simple expression** as an analog to integer. First we define **independent variable** (ind.var.). In  $ab + 3a - 5b$ , we are free to choose any  $a$  and  $b$ . So here,  $a$  and  $b$  are ind.var. In  $ax^2 + bx + c$ , the  $a$ ,  $b$ ,  $c$  are **constants** and must be chosen first, leaving  $x$  as the ind.var. So a simple algebraic expression is one that has no ind.var. in the denominator.

Division in algebra is often used to simplify a complex expression. Simplification increases **clarity**.

*The student must particularly avoid slurring over the sense of what he has before him [and focus] until the meaning of the several parts forces itself upon his memory at first sight, without even the necessity of putting it into words.*

You must grasp the sense of an expression before you can supply the process of simplification:

$$\frac{a^3 - b^3}{a^2 - b^2} = \frac{a^2 + ab + b^2}{a + b}$$

From the forms of number in multiplication, you see that both terms on the LHS are divisible by  $(x - 1)$ . We can verify these general expressions with **sufficient** specific values. If  $a=2$ ,  $b=1$ :

$$\frac{2^3 - 1^3}{2^2 - 1^2} = \frac{2^2 + 2 \cdot 1 + 1^2}{2 + 1}$$

$$\frac{8 - 1}{4 - 1} = \frac{7}{3} = \frac{4 + 2 + 1}{3}$$

So we have grasped the sense and shown it to be true. But we must be sure that our specific values are sufficient. This equation

$$3x - 4 = 2x + 8$$

is only true for  $x = 12$ . This example is absurdly simple. But it shows that no amount of testing that results in falsehood can prove that something is never true. The first fractional example above is an **equation of identity** and this last one is an **equation of condition**. You must be able to see which you are dealing with. Algebraic fractions have the same form and sense as numerical division.

How many times is  $a$  in  $(a + b)$ :  $(a + b)/a$

How many times is  $a$  in  $(ma - na)$ :  $(ma - na)/a = a(m-n)/a = m-n$

Consider  $42a^4b^3c \div 6a^2bc$ :

$$\frac{42a^4b^3c}{6a^2bc} = \frac{6 \cdot 7aaaaabbbc}{6aabc} = \frac{6aabc \cdot 7aabb}{6aabc} = \frac{6aabc}{6aabc} \cdot 7a^2b^2 = 7a^2b^2$$

Or divide the numbers and subtract exponents:

$$42/6 \cdot a^{4-2} \cdot b^{3-1} \cdot c^{1-1} = 7a^2b^2c^0 = 7a^2b^2$$

Algebraic division uses our elementary school algorithm just as algebraic multiplication does. Both require zero-coefficient placeholders for missing power of the variables. I will give you one example. Make yourself some more. Remember that you will get remainders which are the numerator of a fraction, the denominator of which is the divisor. Here's your example:

$$\begin{array}{r} x - y \quad x^4 + x^3y - 3x^2y^2 + 2xy^3 - y^4 \quad (x^3) \\ \underline{x^4 - x^3y} \phantom{- 3x^2y^2 + 2xy^3 - y^4} \\ 2x^3y - 3x^2y^2 \phantom{+ 2xy^3 - y^4} \quad (2x^2y) \\ \underline{2x^3y - 2x^2y^2} \phantom{+ 2xy^3 - y^4} \\ -x^2y^2 + 2xy^3 \phantom{- y^4} \quad (-xy^2) \\ \underline{-x^2y^2 + xy^3} \phantom{- y^4} \\ xy^3 - y^4 \phantom{+ 2xy^3 - y^4} \quad (y^3) \\ \underline{xy^3 - y^4} \\ 0 \end{array}$$

So the quotient is:  $x^3 + 2x^2y - xy^2 + y^3$

This next polynomial division is more an example of formatting. We will divide  $8x^6+8x^5-20x^4+40x^3-50x^2+30x-10$  by  $2x^4+3x^3-4x^2+6x-8$ :

$$\begin{array}{r} 8 \quad 8 \quad -20 \quad 40 \quad -50 \quad 30 \quad -10 \quad | \quad 2 \quad 3 \quad -4 \quad 6 \quad -8 \\ \underline{8 \quad 12 \quad -16 \quad 24 \quad -32} \phantom{+ 30x - 10} \quad | \quad 4 \quad -2 \quad 1 \\ -4 \quad -4 \quad 16 \quad -18 \quad 30 \phantom{- 10} \\ \underline{-4 \quad -6 \quad 8 \quad -12 \quad 16} \phantom{+ 30x - 10} \\ 2 \quad 8 \quad -6 \quad 14 \quad -10 \\ \underline{2 \quad 3 \quad -4 \quad 6 \quad -8} \\ 5 \quad -2 \quad 8 \quad -2 \end{array}$$

So the quotient is  $4x^2-2x+1$  and the remainder is  $5x^3-2x^2+8x-2/2x^4+3x^3-4x^2+6x-8$ . This format gives us a compact way to write down our algorithm. The next example is one of those "Whoa! You can do that?" moments. It will take a some thought to see what is going on but the effort has its reward.

[Cont'd next page.]

We divide  $x^3+px^2+qx+r$  by  $x-a$ :

$$\begin{array}{r}
 1+p \quad q \quad r \quad | \underline{1-a} \\
 \underline{1-a} \qquad \qquad \qquad | 1 + (a+p) + (a^2+ap+q) \\
 (a+p) \quad q \qquad \qquad \qquad \\
 \underline{(a+p) - (a^2+ap)} \qquad \qquad \qquad \\
 (a^2+ap+q) \quad r \qquad \qquad \qquad \\
 \underline{(a^2+ap+q) - (a^3+a^2p+aq)} \qquad \qquad \qquad \\
 a^3+a^2p+aq+r
 \end{array}$$

Here's the punchline: the quotient is  $x^2+(a+p)x+(a^2+ap+q)$  and the remainder is obvious.

This next example is called Synthetic Division and we will use it to illustrate the Remainder Theorem and then we'll prove the theorem (because the proof is wicked easy.) In this synthetic division, we think in terms of dividing by  $x-a$ . If we divided instead by  $(x+2)$ , we would think in terms of  $(x-(-2))$ . Let's divide  $2x^4-3x^2+6x-4$  by  $x-2$ :

$$\begin{array}{r}
 2 \quad 0 \quad -3 \quad 6 \quad -4 \quad | \quad 2 (=a) \\
 \underline{4 \quad 8 \quad 10 \quad 32} \\
 2 \quad 4 \quad 5 \quad 16 \quad 28
 \end{array}$$

Here's what we did: From left to right, we brought down the 2. Then we multiply it by a or 2 and get 4. Add  $0+4 = 4$ .  $4 \times a = 8$ . Add for 5 and so on. The quotient here is  $2x^3+4x^2+5x+16$  and the remainder is 28. And 28 is **also** the value of the polynomial if  $x=a$ . So if you plug in 2 for  $x$  and do the math, you will get 28. The Remainder Theorem says that if we divide a polynomial by a binomial  $(x-a)$  the remainder will be the value of the polynomial at  $x=a$ .

### Proof of Remainder Theorem

Let the polynomial be  $f(x)$ .

By division,  $f(x)/(x-a) = q(x) + r/(x-a)$       ( $q(x)$  is the quotient)

$\therefore f(x) = (x-a)q(x) + r$       (multiply both sides by  $x-a$ )

$\therefore f(a) = (a-a)q(a) + r = 0 \cdot q(a) + r = r$

Proofs don't get any easier than that. You can use synthetic division with this theorem to factor a polynomial. If you divide by  $(x-a)$  and there is no remainder, then  $f(x)$  is divisible by  $(x-a)$  without remainder and  $(x-a)$  is a factor of  $f(x)$ . It follows that in such a case  $f(a)=0$  or  **$a$  is a root of  $f(x)$** . More on this later.

Let's examine the form of the natural numbers as they are used:

To multiply by 5: add a 0 and divide by 2

$$32 \cdot 5: 320 \div 2 = 160$$

To divide by 5:  $\times 2$ , last digit =  $2 \times$  remainder, digits to left are quotient:

$$32 \div 5: 32 \cdot 2 = 64, 4/2 = 2 \therefore 6 \text{ r } 2$$

To multiply by 25: add two 0s, divide by 4:

$$32 \cdot 25: 3200 \div 4 = 800$$

To divide by 25:  $\times 4$ , last 2 digits =  $4 \times$  remainder, digits to left are quotient:

$$32 \div 25: 32 \cdot 4 = 128, 28 \div 4 = 7 \therefore 1 \text{ r } 7$$

To multiply by 9: add a 0, subtract number:

$$32 \cdot 9: 320 - 32 = 288$$

We can also consider dividing the natural numbers as they are in themselves and their factors become a natural extension of the division idea. We define **divisibility** of a by b as "a is divided by b without remainder." Then b is a **factor** of a. For lazy notation, we will use **divby**:

6 divby 3 6 is divisible by three w/out remainder  
6 !divby 5 6 is not divisible by 5 w/out remainder

If a number is divisible only by itself and 1, it is a **prime** number, i.e., 1, 3, 5, 23, 113. Euclid easily proves that there are infinite primes. (Go look it up.) Numbers can be prime to each other when they have no common factors: 12 and 21 are prime to each other, 12 and 15 are not. We will notate this "prime to e.o." as p(12,21).

You can learn to see elements of divisibility:

<u>divby</u>	<u>test</u>
2	units digit even
4	last two digits divby 4
8	last three digits divby 8
3	sum of digits divby 3
9	sum of digits divby 9
5	last digit 0 or 5
6	units digit even, sum of digits divby 3

The case of 3 and 9 is due to our positional notation being decimal. Here is an example that will explain this:

1134 = 1000 + 100 + 30 + 4  
= 999+1 + 99+1 + (3·9)+3 + 4  
Clearly, (999 + 99 + (3·9)) divby 3 or 9  
So is the remainder (1 + 1 + 3 + 4) divby 3 or 9?

The explanation for this next idea is up to you. Consider:

12300000 ) 42176189300 ( ???

Drop zeroes in divisor and the same number of digits in the dividend. Save these for the remainder:

123 ) 421761 ( 3428

369

527

492

356

246

1101

984

117**89300**

There is a general principle at work here. When we understand something in general terms, we can use it freely in our work.

When we use division, the quotient is the same if you multiply or divide **both** the divisor and dividend by the same number. This becomes obvious in fractions:

Take 32, 4                    32 ÷ 4 = 8  
(×3) 96, 12                96 ÷ 12 = 8  
(÷2) 16, 2                 16 ÷ 2 = 8

There is a **proportional** relation between 32 and 4, or between any two numbers. For 32 and 4, the proportional relation is 8. For a and b, the relation is  $a/b$ . But we generally call  $a/b$  proportional when  $a/b = n$  for some  $n \in \mathbf{N}$ . The relation of 4 and 32 is  $1/8$ , for b and a,  $b/a$ . That's all there is to proportion. In mathematics, we name a thing when it bears talking about. The proportion is unchanged under multiplication and division by a common number or:

$$ma/mb = a/b$$

$$(a/n)/(b/n) = a/b$$

Adding or subtracting the same number to each is not proportional. In our example of 32 and 4,  $32 - 3$  is a decrease of 10.67% but  $4 - 3$  is a decrease of 75%. Multiplying both by three, increases both by 300%. The following are some simple consequences of these ideas:

$$(a/b)/c = a/bc \quad ab/c = b/c \cdot a \quad ab/c = a/(c/b)$$

Let's go back to the idea of **factors**. Both 4 and 3 are factors of 12 because  $4 \cdot 3 = 12$ . The more precise idea of factors uses only **prime factors**. The factors of 12 are then  $2^2$  and 3.

If a number (5) is a factor of two others (20, 25) it is a factor of their sum (45) and their difference ( $\pm 5$ ). We get  $-5$  from  $20 - 25$  and  $-5 = -1 \times 5$ . A negative integer is the product of a natural number and negative one. The factors of  $-12$  are  $-1, 2^2$ , and 3. Of course, the factors of 12 are  $1, 2^2$ , and 3 but we ignore the 1 where we can't ignore  $-1$ .

If a number (5) is a factor of a second number (15) it is a factor of of any number of which the second number is a factor (30). In general terms, if **a** (5) is a factor of **b** (15) it is a factor of **nb** ( $30=2b, 105=7b, 1665=111b$ ). All of this is shown by division.

Even more interesting, in division if a number divides the dividend and the divisor, it divides the remainder:

$$\begin{aligned} 360 \div 112 &= 3 \text{ r } 24 \\ 360 &= 112 \cdot 3 + 24 \\ 360 &= 336 + 24 \\ 360 - 336 &= 24 \\ 4 \cdot 90 - 4 \cdot 84 &= 4 \cdot 6 \end{aligned}$$

So four divides dividend, divisor, and remainder. But one example doesn't actually give us peace of mind. Let's prove this for the general case. You will see that a proof can often be the simplest explanation. If you have one of those broader minds we talked about, approaching things at this level is something you need to develop because it excludes the extraneous. In the proof, for  $360 = 112 \cdot 3 + 24$  we use the completely general  $a = b \cdot q + r$ :

### Theorem

If a number divides a dividend and divisor, it divides the remainder.

### Proof

$$a = b \cdot q + r$$

If some c divides a and b then  $a =$  something times c or " $a = sc$ " and

$$b = \text{something else times } c \text{ or } "b = tc"$$

$$\therefore sc = tcq + r \quad (\text{simple substitution})$$

$$\therefore sc - tcq = r \quad (\text{both sides } -tcq)$$

$$\therefore c(s - tq) = r \quad (\text{Distributive Law})$$

$\therefore$  dividend a, divisor b, and remainder r all divy c

This proof leads us directly to the idea of **Greatest Common Factor**. This was originally called Greatest Common Measure and is sometimes called Greatest Common Divisor. All mean the same thing: Euclid's Algorithm (Euclid VII.1) -- which is used on natural numbers, polynomials, and abstract algebraic structures as a test of whether something behaves like an integer or not.

It's all very simple: Take two numbers. Divide the larger by the smaller. Then repeatedly divide divisors by remainders. Last **divisor** is the greatest common factor of the two numbers or  $\text{gcf}(a,b) = c$ . Let's do the  $\text{gcf}(360,112)$  which should be 8:

$$\begin{array}{r}
 112 \overline{)360} \quad (3) \quad \text{(dividing larger by smaller)} \\
 \underline{336} \\
 24 \overline{)112} \quad (4) \quad \text{(dividing divisor by remainder)} \\
 \underline{96} \\
 16 \overline{)24} \quad (1) \quad \text{(dividing divisor by remainder)} \\
 \underline{16} \\
 8 \overline{)16} \quad (2) \quad \text{(dividing divisor by remainder)} \\
 \underline{16} \\
 0
 \end{array}$$

The last divisor is the GCF  $\therefore \text{gcf}(360,112) = 8$ . Numbers that are prime to each other have a GCF of one. Let's do  $\text{gcf}(123,4)$ :

$$\begin{array}{r}
 4 \overline{)123} \quad (3) \\
 \underline{12} \\
 3 \overline{)4} \quad (1) \\
 \underline{3} \\
 1 \overline{)3} \quad (3) \\
 \underline{3} \\
 0
 \end{array}$$

Last divisor is 1  $\therefore \text{gcf}(123,4) = 1$ . 123 and 4 are prime to e.o. (each other). If you divide two numbers by their GCF, the quotients will be prime to each other, which is obvious if you think about it:

$$360 \div 8 = 45 = 9 \cdot 5 \quad 112 \div 8 = 14 = 2 \cdot 7 \quad \text{By inspection, } \text{gcf}(45,14) = 1.$$

You have seen that polynomials can be divided as easily as numbers. What is true of one is, in general, true of the other. Two polynomials can have a GCF or be prime to each other. A polynomial is an **integral function of x** when the variable of the polynomial is x and the coefficients of each term is an integer. And just as for numbers, if A,B,Q,R are integral functions of x, then division takes the same form:  $A = BQ + R$  and  $\text{gcf}(A,B) = \text{gcf}(B,R)$  just as we proved for numbers.

Let's think about the implications of that last bit and use what we find to simplify finding the GCF of polynomials. To the remainder or divisor, you can add or remove an integral function factor so long as this polynomial factor has no factor in common with both. In other words, you can add or remove something which does not play into the GCM if it makes things easier. You can remove a factor common to both and simplify things so long as you **multiply that factor back into the GCM** where it belongs. And we can always add or remove a numerical factor to the remainder, divisor, or both without affecting the GCM.

Let's do three examples of this. It's all very simple: Take two integral functions. Divide the larger by the smaller. Then repeatedly divide divisors by remainders. Last divisor is the greatest common factor of the two polynomials.





The third example is not trivial. It uses the above abbreviated notation. Try to come to an understanding of it. I have added some explanatory notes at the end so that you won't miss out on anything important.

Example. 3. GCF of  $4x^4 + 26x^3 + 41x^2 - 2x - 24$  and  $3x^4 + 20x^3 + 32x^2 - 8x - 32$ :

$$\begin{array}{r}
 \begin{array}{cccc|cccc}
 4 & 26 & 41 & -2 & -24 & 3 & 20 & 32 & -8 & -32 \\
 1 & 6 & 9 & 6 & 8 & & 2 & 5 & -26 & -56 \\
 \hline
 2 & 12 & 18 & 12 & 16 & & -53 & -318 & -424 & \\
 7 & 44 & 68 & 16 & & & 1 & 6 & 8 & \\
 1 & 29 & 146 & 184 & & & & & & \\
 \hline
 23 & 138 & 184 & & & & & & & \\
 1 & 6 & 8 & & & & & & & \\
 \hline
 & & & & & & & & & 0
 \end{array} \\
 (\times 2) & & & & & & & & & \\
 & & & & & & & & & (\div -53) \\
 (\div 23) & & & & & & & & & 
 \end{array}$$

Top line is first dividend A and divisor B. 2d line LHS is A-B which is the 1st remainder. Or  $A = 1 \cdot B + R$ . 2d line RHS is then the 2d remainder which divides  $2 \times 1$ st remainder, for simplicity. 5th line LHS is the 4th line LHS minus  $3 \times$  the 2d line RHS. Then 5th line LHS divides 2d line RHS and so on. If you can't get this example to make sense, work it out the long way as in example one. You **can** come to an understanding of anything you put your mind to. Do not settle for less.

*If the student be careful to pay more attention to the principle underlying the rule than to the mere mechanical application of it, he will have little difficulty in devising other modifications of it to suit particular cases.*

Even if you never again calculate the GCF of polynomials, using your mind to simplify something according to underlying principles in order to clearly grasp a solution is a skill worth every moment you can put into it.

That last example was a bit of an effort, wasn't it? Let's do something easy for a change. Let's do the **Least Common Multiple**. If you ask me, the Least Common Multiple is a case of a poorly named idea. The least common multiple of 4 and 6 is 12. How is 12 a multiple of 4 and 6? If you use only one 4 and one 6, you get 24. Who chose this name? There are many naming problems in mathematics. And they are caused by mathematicians trying to use language in a normal fashion when all they ever think about is numbers in an abnormal fashion. You know that studying a book like this isn't normal. Normal people read books about vampires. We are clearly abnormal. But I digress.

Let's come to an understanding of the least common multiple. If a divby b, then b is a **factor** of a and a is a **multiple** of b. 56 divby 8. So 8 is a factor of 56 and 56 is a multiple of 8. Precisely speaking,  $56 = 7 \times 8$ . So 56 is a **common multiple** of 7 and 8.

$$a, b \in \mathbf{N}, a \cdot b \text{ is } \mathbf{common\ multiple} \text{ of } a \text{ and } b$$

56 happens to be the **least common multiple** of 7 and 8. Any others multiples of these,  $14 \times 8$  or  $24 \times 7$ , are larger than 56. But 12 is the least common multiple of 4 and 6. Here's the deal. The Least Common Multiple or LCM should be called the BCF or Bucket of Common Factors. Take two numbers, 7 and 8. Factor them:  $7, 2^3$ . Throw one of them in the bucket: throw the 7. Now ask yourself, what factors do I not have in the bucket in order to make the second number. Well, I don't have any twos and I need three of them. So I throw the whole 8 in the bucket. To get the Least Common Multiple, I just multiply everything in the bucket. In this case, 56. Now let's do 4 and 6 or  $2^2$  and  $2 \cdot 3$ . Throw the 4 in the bucket. You now have two 2s in the bucket. What do you not have in the bucket to

make a 6? You have more twos than you need. You only need a 3. Toss in a three. Multiplying together everything in the bucket, you get the Least Common Multiple of 4 and 6:  $2 \cdot 2 \cdot 3 = 12$ . It stills seems like 12 is not a common multiple of 4 and 6. Just forget about that and think Bucket of Common Factors.

It just so happens that the LCM is related to the GCF. If you find the GCF of 4 and 6, which is 2, you can divide one of your numbers by the GCF or ( $4 \div 2 = 2$ ) and multiply the other number by the result ( $2 \times 6 = 12$ ). It doesn't matter which numbers you use. Just divide one by the GCF and multiply the other by the result. Clearly, if  $\text{gcf}(a,b) = 1$  then  $\text{lcm}(a,b) = a \cdot b$ .

$$\begin{aligned} \text{Required: } \text{lcm}(36,8) \\ \text{gcf}(36,8) &= 4 \\ 36 \div 4 &= 9 \quad 9 \cdot 8 = 72 \quad \text{OR} \quad 8 \div 4 = 2 \quad 2 \cdot 36 = 72 \\ \therefore \text{lcm}(36,8) &= 72 \end{aligned}$$

To find  $\text{gcf}(a,b,c)$ :  $\text{gcf}(a,b) = d$      $\text{gcf}(d,c) = \text{gcf}(a,b,c)$   
 To find  $\text{lcm}(a,b,c)$ :  $\text{lcm}(a,b) = d$      $\text{lcm}(d,c) = \text{lcm}(a,b,c)$   
 And symmetrically for  $\text{gcf}/\text{lcm}(a,b,c,d,\dots)$

Here's one more thing to chew on before we wrap up division and go on to fractions. Let's say you are dividing 146.08 by 0.00279 or vice versa. Where does the decimal point go in the answer? You can do this in your head. We use the idea of **characteristic** from logarithms. If you take the first significant (non-zero) digit of a number, that digit is in the  $10^x$  place. Then  $x$  is the characteristic.

Number	1st sig. digit	Place	Characteristic
1.37	1	$1 = 10^0$	0
213.6	2	$100 = 10^2$	2
0.00021	2	$1/10000 = 10^{-4}$	-4

To place the decimal point in division:

1. Find the characteristic of dividend and divisor;
2. If 1st significant digit of divisor  $>$  1st significant digit of dividend, add 1 to characteristic of divisor;
3. Characteristic of result = characteristic dividend minus characteristic divisor.

$$\begin{aligned} a &= 146.08 \quad \text{char} = 2 \\ b &= 0.00279 \quad \text{char} = -3 \\ \text{for } a/b: & 2 - (-3 + 1) = 4 \quad (+1 \text{ since } 2 \text{ in } 279 > 1 \text{ in } 146 \text{ from \#2 above}) \\ & 14608 \div 279 = 52.3584 \quad (\text{ignore decimal point}) \\ \therefore a/b &= 52358.4 \quad \text{char} = 4 \\ \text{for } b/a: & -3 - 2 = -5 \\ & 279 \div 14608 = 0.019099 \quad (\text{ignore decimal point}) \\ \therefore b/a &= 0.000019099 \quad \text{char} = -5 \end{aligned}$$

## Fractions

What times four equals seventy-one? Quickly, now! I must know!

$$4)71(17 \text{ r } 3 \therefore 17 \frac{3}{4} \times 4 = 71$$

The remainder in division is the remainder divided by the divisor or a **fraction**. Division leads to fractions. When we say fractions, we mean

$$\forall m, n \in \mathbf{Z}, \frac{m}{n} \in \mathbf{Q}$$

Or, "Given any  $m, n$  in the integers,  $m/n$  is a rational number in  $\mathbf{Q}$ ", the set of **rationals**, or of one signed integer divided by another. This next quote should be in every public school arithmetic text, shouldn't it?

*We would recommend the student not to attend to the distinctions of proper and improper, pure or mixed fractions. etc., as there is **no distinction** whatever in the rules, which are common to all these fractions.*

Most of the problems people have with fractions come from these false distinctions that are nothing but busywork used to fill up a textbook. Fractions are meaningful and their meaning can be understood. Let's just riff for a bit on the idea of fractions. Just absorb each idea as we go along.

$56/8$  can mean "divide 56 into 8 parts." So each part is 7. Then  $56/8 = 7$ . But fractions don't have to come out evenly. We can divide  $57/8$  into 8 parts, too.  $57/8 = 56/8 + 1/8$ . Each part is then  $7 + 1/8$  or  $7 \frac{1}{8}$ .

Algebraically,  $\forall c \in \mathbf{N}, c/c = 1$ . So  $a/b = a/b \times c/c = ac/bc$ . Then  $3/5 = 3/5 \times 4/4 = 12/20$ . We divide 3 into 5 parts and 12 into 20 parts. Because they are equal fractions, for every 3 in 12 there is a 5 in 20. There are 4 threes in 12 and 4 fives in 20. And we use this idea to simplify fractions. If we have  $12/20$ , we can factor the numerator (top number) and the denominator (bottom number) like this  $(4 \times 3)/(4 \times 5)$ . And because  $4/4 = 1$ , we can eliminate it, leaving us with  $3/5$ . No matter how complicated the fraction, simplifying it is simply discarding ones. One times any thing is that thing. When we have discarded all the ones, the fraction is **in lowest terms** or **in simplest form** and the numerator and denominator are prime to e.o.

Using the same example, let  $c = 1/d$ . Then  $a/b = ac/bc = (a \times 1/d)/(b \times 1/d) = (a/d)/(b/d)$ . But  $(1/d)/(1/d)$  is simply another form of the number 1. So we can discard it.

$$\frac{4}{5} \frac{1}{7} = \frac{4 \times \frac{1}{7}}{5 \times \frac{1}{7}} = \frac{4}{5}$$

Integers can take the form of fractions.  $7 = 7/1 = 14/2 = 21/3 = \dots$  We're multiplying by ones again:  $1/1, 2/2, 3/3, \dots$  So  $7 \cdot 8 = 14/2 \cdot 16/2 = 224/4 = 56 = 7 \cdot 8$ . Fractions, or the rationals  $\mathbf{Q}$ , are an expansion of number. At some point, people went from counting objects to counting parts of a whole. Fractions are the result.

*Whenever we pass from that which is simple to that which is complex, we shall see the necessity of carrying our terms with us and enlarging their meaning, as we enlarge our ideas. This is the **only** method of forming a language which shall approach in any degree*

towards **perfection**; and more depends upon a well-constructed language in mathematics than in anything else. Mathematics is a language and languages have meaning.

With fractions, the terms we carry with us and enlarge are the operations of arithmetic. Let's look at the forms these operations take before we go into detail.

1. $a/c + b/c = (a+b)/c$	2. $a/b+c/d = ad/bd+cb/db = (ad+bc)/bd$
3. $a/b - c/b = (a-c)/b$	4. $a/b - c/d = (ad-bc)/bd$
5. $a/b = a \times 1/b$	6. $a/b = ma/mb$
7. $a/b \times c/d = ac/bd$	8. $a/b \div c/d = a/b \times d/c = ad/bc$

Again, in all fractions, the upper number is the **numerator**, lower number is **denominator**. If num < denom, then fraction < 1. If num = denom, then fraction = 1. If num > denom, then fraction > 1. Determining if an algebraic fraction is less than one is a common necessity in algebra, analysis, and the Calculus.

The first two forms above are for addition. The simplest case is when both fractions have the same denominator. To add  $1/3$  and  $4/3$ , you are adding thirds just as if they were oranges. One third plus four thirds are five thirds:  $1/3 + 4/3 = 5/3$ .

The only other case of addition is when the denominators are not the same. Consider

$$3/4 + 5/6$$

and think back to common multiples. We know that for  $\forall a,b \in \mathbf{N}$ ,  $a \cdot b$  is a common multiple. So 24 is a common multiple of the denominators 4 and 6. We can't add fourths and sixths. But we can add twenty-fourths. So we use a common multiple and multiply by ones:

$$3/4 \times 6/6 + 5/6 \times 4/4 = 18/24 + 20/24 = 38/24$$

If you think for a moment, you can see that  $38/24$  can be reduced to  $19/12$ . Thinking back to Least Common Multiple, what is  $\text{lcm}(4,6)$ ? So depending upon what is simpler and easier, we can also find the LCM of the denominators and then multiply by ones:

$$3/4 \times 3/3 + 5/6 \times 2/2 = 9/12 + 10/12 = 19/12$$

This is **absolutely all** there is to adding fractions. If you have two big polynomial fractions with different denominators, the process is exactly the same as with  $3/4$  and  $5/6$ . You multiply each by ones, such that the denominators are common (ideally, least common) multiples and then add oranges and oranges. It all comes down to arithmetic which is a tedious process with too many opportunities to mess up. But it is simply arithmetic. Before we go on to subtraction, consider the usefulness of this form:

$$a/b + c/d = (ad+bc)/bd$$

The result of **any addition of fractions** takes precisely this form. Leverage the form.

Now most school texts will go on and on with addition of fractions as if there were any difference between adding  $3/4$  and  $5/6$  and  $15/4$  and  $35/6$ . But there isn't any difference, is there? You now know all there is for addition of fractions. If you feel like you need practice in order to master this, then practice. Otherwise, let's go on to subtraction.

But wait, you say. What about  $3^{3/4} + 5^{5/6}$ ? Okay, that's a fair question. But you already know that  $3^{3/4}$  is  $3 + 3/4$  from two pages back. And you also know that  $3 + 3/4$  is actually equal to  $3/1 + 3/4$  because we covered that too. So you turn each part of  $3^{3/4} + 5^{5/6}$  into a fraction and then add the fractions. Then, if you think about it, each part is easily handled:

$$a + \frac{b}{c} = a \times \frac{c}{c} + \frac{b}{c} = \frac{ac}{c} + \frac{b}{c} = \frac{(ac+b)}{c}$$

So  $3^{3/4}$  is  $(3 \cdot 4 + 3)/3 = 15/4$  and  $5^{5/6}$  is  $(6 \cdot 5 + 5)/6 = 35/6$  and you can add those two fractions with what you already know. Here's another legitimate question: what about adding several fractions:

$$1/10 + 5/6 + 7/9$$

Clearly, you could add the first two and add the result to the third. Or you could find the lcm(10,6,9) using your Bucket of Common Factors: 2·5, then a 3 for the 6, then another 3 for the 9 gives you  $2 \cdot 5 \cdot 3 \cdot 3 = 90$  and you know how to multiply by ones to get

$$9/90 + 75/90 + 70/90 = 154/90$$

Note that the LCM does not always automatically put the result in lowest terms ( $77/45$ ). But it's better than multiplying every denom to get the common multiple of 540. The lesson here is that the LCM is actually simpler in use unless the addition is almost calculable in your head. You should also notice that the common denominator allows comparison:

$$9/90 < 70/90 < 75/90 \therefore 1/10 < 7/9 < 5/6$$

If two fractions have the same denominator, the greater fraction has the greater numerator. Sym. (symmetrically) if two have the same numerator, the greater has the smaller denominator:  $2/3 > 2/5$ .

School textbooks will spend a chapter on adding fractions and then spend another chapter on subtracting fractions. But you already know how to subtract and not just numbers but integral functions as well. And you can see that fraction forms #3 and #4 are forms #1 and #2 with a minus sign. If you know everything about adding fractions (and now you do), you know everything about subtracting fractions.

Many people dislike mathematics because it is presented in a meaningless, complex way when you can feel, if not actually understand, that it is much more simple. And if you do understand it, you hate mathematics because the teacher and the text are monotonously wasting your time. I love mathematics and I refuse to spoil it for anybody. You clearly know everything there is to know about subtracting fractions. Let's do multiplication. The fifth form

$$a/b = a \times 1/b$$

simply points out the obvious. Four thirds are nothing but four taken one-third times or

one-third taken four times. Either could be the case if you are talking about something real. Think about that long enough to come up with examples of each.

Calculating thoughtlessly deprives the symbols of meaning and makes them inapplicable to anything. Problems in schoolbooks are often mere puzzles. Life and the world have no such meaningless problems. The sixth form

$$a/b = ma/mb$$

we have already covered. A fraction times one, in any form, is equal to the fraction. So we can always multiply by one. And, more to the point, we can simplify by eliminating ones. The seventh form

$$a/b \times c/d = ac/bd$$

is easily understood if we actually consider what it means. Using some numbers, we have:

$$14/2 \times 16/2$$

This is dividing  $14/2$  into two parts (each =  $14/2 \times 1/2$ ) and taking 16 of these for ( $16/2$  we are taking 16 halves or  $16 \times 1/2$ ). Therefore we have  $7/2 \times 16 = 112/2 = 56$ . It works the other way as well because multiplication is commutative. We can divide  $16/2$  into 2 parts and take 14 of them which gives us the same thing:  $8/2 \times 14 = 112/2 = 56$ . And this gives us our algorithm for multiplying fractions:

$$14/2 \times 16/2 = (14 \cdot 16)/(2 \cdot 2) = 224/4 = 112/2 = 56$$

Therefore, form seven gives us the general solution for any multiplication of fractions and  $2/3 \times 5/6 = 10/18 = 5/9$ . What about  $9 \times 2/7$ ? Simply treat 9 as  $9/1$ .

$$9/1 \times 2/7 = 18/7$$

Sometimes you can simplify such things on the fly by leveraging the form of number.

$$\begin{aligned} a \times b/c &= (a \cdot b)/c = a/c \times b \\ 9 \times 2/3 &= 2 \times 9/3 = 2 \times 3 = 6 \\ 6 \times 7/36 &= 6/36 \times 7 = 1/6 \times 7 = 7/6 \end{aligned}$$

Mathematics is the study of form within the domain of number. The more forms you understand, the greater your power. To test your understanding, explain  $14/3 \times 2/13$  the way we did  $14/2 \times 16/2$ . Do not make this hard. Simplicity is what it is.

Now you now know **all there is** to multiplying fractions. You can multiply numbers. You can multiply polynomials. Multiply the numerators and put the result on the top. Multiply the denominators and put the result on the bottom. Simplify, if you can. And you're done. Let's think about the final form:

$$a/b \div c/d = a/b \times d/c = ad/bc$$

$3/4 \div 2/5$  asks "How many parts must  $2/5$  be divided into and then how many of those parts must be taken in order to have  $3/4$ ?" Give the fractions common denominators and we have  $15/20 \div 8/20$ . Divide  $8/20$  into 8 parts each equal to  $1/20$ . If you take 15 of this sized part, you get  $15/20 = 3/4$ . So the quotient is  $15/8$  or the sum of 15 of an eighth part of  $2/5$ . It turns out that this leads to the eighth form above:

$$3/4 \div 2/5 = 3/4 \cdot 5/2 = 15/8$$

Division of a fraction by whole numbers simply treats the whole as a fraction.

$$\begin{aligned} 2/3 \div 9 &= 2/3 \div 9/1 = 2/3 \cdot 1/9 = 2/27 \\ 9 \div 2/3 &= 9/1 \div 2/3 = 9/1 \cdot 3/2 = 27/2 \end{aligned}$$

Remember that  $9 \div 2/3$  asks "How many  $2/3$  are in 9?" If the result is  $27/2$  then we have  $27/2 \cdot 2/3 = 27/3 = 9$ . And so from the former example, there are  $2/27$  of a 9 in  $2/3$ . Mathematical results have meaning even with respect to the simplest calculation.

Note that the order of division is important.  $3/4 \div 2/5$  is like  $16 \div 2$ . In this order, we get  $15/8$  and 8. But if we change the order to  $2/5 \div 3/4$  and  $2 \div 16$ , we get  $8/15$  and  $1/8$  because **the meaning of the question is different**. As an exercise, state the question, as in the last paragraph, for  $2/5 \div 3/4$ .

We can also go from a question to its mathematical statement: "What length is two and a half times the length which when taken four-ninths of a time is a mile?" Or what is

$$2 \frac{1}{2} \div 4/9 = 5/2 \div 4/9 = 5/2 \cdot 9/4 = 45/8 = 5 \frac{5}{8}$$

miles? Work until you can understand this question, its method of solution, and its answer. Mathematics is often taught as abstract and formal -- which is to say, meaningless -- because thinking meaningfully is **hard**. But there can be no significance without meaning. Significant mathematics, in its most abstract form, is full of meaning. Conversely, when it is not conveying meaning, it is not significant.

*Multiplication and division of fractions is an **extension** of these ideas from whole numbers into fractional numbers. The extension is in every way **consistent**.*

A final riff on fractions and meaning. Let  $AB = 1$  foot. Divide  $AB$  into seven parts. Then  $AC = 1/7$  foot.  $AD = DF = 2/7$  foot. And so on.

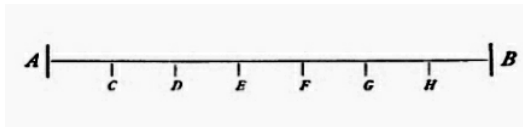

1. What is  $1/3$  plus  $1/7$  of a foot?
2. What is  $1/4$  of  $2/7$  of a foot?
3. What is  $2/5$  of  $1/3$  of  $3/4$  of a foot?
4. Into how many parts must  $3/7$  of a foot be divided and how many of these parts taken to make  $14/15$  of a foot?

In each case there is an arithmetical expression to be resolved. But in each question there is a meaning. If you do not carry the meaning into the arithmetic and bring it back out, your effort has been meaningless, your time wasted. For what could  $1/14$  on its own possibly mean?

A note on #4 and mathematics as a language. A page back, we asked the question "How many parts must  $2/5$  be divided into and then how many of those parts must be taken in order to have  $3/4$ ?" This is very similar to #4, isn't it?



When we learn any language, we learn that when speaking of similar things, the form remains about the same while the details change.

Mathematics is a language. The question about  $2/5$  and  $3/4$  **is precisely** the question about  $3/7$  and  $14/15$ . Your job is to learn how to speak this answer in general. And to do this you must learn what each part of the answer means. In this problem, make sure you understand the difference between the  $98/45$  and the  $98/105$ .

Before we go into decimal fractions, let's show that even if our fractions are made out of fractions that everything we know to be true still applies. We know that

$$\begin{aligned} ma/mb &= a/b = (a/n)/(b/n) \\ 20/16 &= 5/4 = (5/2)/(4/2) \end{aligned}$$

Clearly, the middle fraction is simplest. Let's say you have a complex fraction in the form of

$$(a/b)/(c/d)$$

We know this is  $ad/bc$ . To find the simplest form or to reduce to lowest terms, find the  $\text{gcf}(ad, bc) = f$ . Then  $(ad/f)/(bc/f)$  is in lowest terms.

$$\begin{aligned} (33/16)/(27/12) &= (33 \cdot 12)/(27 \cdot 16) = 396/432 \\ \text{gcf}(396, 432) &= 36 \quad 396/36 = 11 \quad 432/36 = 12 \\ \therefore (33/16)/(27/12) &= 11/12 \end{aligned}$$

Another way:  $(33 \cdot 12)/(27 \cdot 16) = (11 \cdot 3 \cdot 3 \cdot 4)/(3 \cdot 3 \cdot 3 \cdot 4 \cdot 4)$  Removing the ones ( $3/3$ ,  $3/3$ ,  $4/4$ ) leaves  $11/12$ . So if numbers can be factored in your head, cancellation is easier than finding the GCF. With algebraic fractions, factoring is harder and we fall back on the GCF. In every way, fractions of fractions are just fractions. This is nothing but form #2.

$$\frac{\frac{3}{4}}{\frac{2}{7}} + \frac{\frac{1}{5}}{\frac{3}{2}} = \frac{\frac{3}{4} \cdot \frac{3}{2} + \frac{1}{5} \cdot \frac{2}{7}}{\frac{2}{7} \cdot \frac{3}{2}} = \frac{\frac{9}{8} + \frac{2}{35}}{\frac{6}{14}} = \frac{\frac{531}{280}}{\frac{6}{14}} = \frac{331}{120}$$

You should prove to yourself the following two equations:

$$1) \frac{(a/b)(c/d) + (e/f)(g/h)}{(a/b)(e/f) + (c/d)(g/h)} = \frac{acfh + bdeg}{aeth + bcfg}$$

$$2) \frac{\frac{1}{a + \frac{1}{b + \frac{1}{c}}}}{c} = \frac{bc + 1}{abc + a + c} \quad (\text{The stupid dots are software work-arounds.})$$

Decimal fractions are the "metric system" of fractions, simplifying operations while truncating results.  $1/7 = 0.142857142857142857\dots$  We will talk later about this cyclic repetition. The LHS is a complete expression. The RHS can only be partially (infinitesimally) expressed and does not easily reveal its equivalence to  $1/7$ . In much of mathematics, you will find your life is easier and your results truer if you stick to the simple fractions and avoid the truncations (and register overruns) of your calculator. Only fractions with denominators having factors of  $2^n$  and  $5^m$ ,  $m, n \in \mathbf{N}$ , reduce finitely to decimal fractions. But this isn't as simple as it sounds.

$$7/16 = 70000/160000 = 16/16 \cdot 4375/10000 = 0.4375$$

Calculators hide what goes on here. If you do this with our division algorithm, you just run out some zeroes until the division terminates:

$$\begin{array}{r}
 16 \overline{)7.0000(0.4375} \\
 \underline{64} \\
 60 \\
 \underline{48} \\
 120 \\
 \underline{112} \\
 80 \\
 \underline{80} \\
 0
 \end{array}$$

But here is why it terminates: In the series 7, 70, 700, ..., the term 70000 is divisible by 16. The decimal fraction is finite because we can cancel the 16. But for 1/7, in the series 1, 10, 100, 1000, ..., there is no term that is ever divisible by 7. So the decimal fraction of 1/7 never ends, although it repeats periodically.

We accept 0.142857 as 1/7 because it is true to within one part in a million. If this introduces an error, we extend the margin of error as needed. But we are always truncating 1/7 by expressing it as a decimal fraction. And if we are accepting a decimal of 1/7, we must keep in mind that 0.143 is closer to 0.142857 than 0.142 is.

In decimal fractions, 17334/1000 is denoted 17.334. The "." or "decimal point" marks off the number of zeroes in the denominator (3 of them) which is its power of ten ( $10^3$ ). 88/10000 needs four places following the "." so we must buffer up with zeroes: 0.0088. Decimal fractions extend our positional notation of decimal numbers:

$$217.3426 = 2173426/10000 = 200+10+7+3/10+4/100+2/1000+6/10000$$

Again, this extension is the extension of our four operators. Addition and subtraction remain identical to normal arithmetic. Just line up the decimal points, add or subtract, and put the decimal point in that same position in your result:

$$\begin{array}{r}
 32.567 \\
 + 8.3356 \\
 \hline
 40.9026
 \end{array}$$

This is **all there is** to addition and subtraction of decimal fractions. Just keep your decimal point in the right place. In multiplication, you have as many decimal places in your result as you have decimal places (or zeroes) in your denominators of the fractions multiplied:

$$\begin{array}{l}
 3/10 \cdot 4/100 = 12/1000 = 0.012 \\
 0.3 \cdot 0.04 = 0.012
 \end{array}$$

1 decimal place + 2 decimal places = 3 decimal places in the result

$$\begin{array}{l}
 0.172 \cdot 0.101 \text{ (3+3 = 6 decimal places) and } 172 \cdot 101 = 17372 \\
 \therefore 0.172 \cdot 0.101 = 0.017372 \text{ (6 decimal places)}
 \end{array}$$

Division of decimal fractions is very simple:

$$6.42 \div 1.213 = 642/100 \div 1213/1000 = 642/100 \cdot 1000/1213 = 642000/121300 \\ = (6420 \cdot 100)/(1213 \cdot 100) = 6420/1213$$

Then you divide the integers with simple arithmetic.

So why do the digits 142758 in  $1/7 = 0.142758142758\dots$  repeat? Here is the beginning of an answer. We have seen that 7 cannot divide any term in 1, 10, 100... evenly. But all fractions like  $1/7$  of one whole number over another have a finite relation between the numbers. After a finite number of divisions, one of the previous results occurs and that leaves the division algorithm in the same state as the first occurrence and the numbers have to repeat. This is not true of  $\sqrt{2}/7$  as there is no finite relation between  $\sqrt{2}$  and 7 or "any relation between the two is an approximation." Expressed as an approximation, we would again have a finite relation and the approximation of  $\sqrt{2}/7$  would terminate or repeat. But an approximation of  $\sqrt{2}$  is not  $\sqrt{2}$  any more than 0.14286 is  $1/7$ .

In general, decimal fractions have been used because it is easier in calculations and we only need approximation. In physics or engineering, we can decide that our results can be off by no more than 0.0001 or choose any other margin of error and truncate all computations to that many decimal places. Until very recently, historically speaking, all calculations were done by hand. If your lab measurements were only true to 1/50 of a something either way, your results were only accurate to two decimal places. So mathematicians came up with ways to multiply such results so that they were accurately truncated at a given number of decimal places. Let me show you two examples and then I will give you something to chew on. We will multiply 88.96 by 7.43 to get two and then three decimal places in the result. I will give you an explanation for the first example and you can supply the reasoning for the second. The actual product is 660.9728.

88.96	(multiplicand with ".")
<u>  347</u>	(multiplier reversed, no "." with unit at 2 decimal places)
62273	(begin with 7·6 but carry 1 in any case)
3558	(begin with 4·9 but carry 2 from 4·6 = 24)
<u>  266</u>	(begin with 3·8 but carry from 3·9 = 27)
660.97	

88.960
<u>  347</u>
622721
35584
<u>  2668</u>
660.973

With that understood, come to an understanding of the similar process for division. Here we are keeping two decimal places:

[Cont'd next page.]

44

0.41432)673.1489(1624.73

414 32  
258 828  
248 592  
10 237  
8 286  
1 951  
1 657  
294  
290  
4  
4  
0

The way to figure this out is to do the division longhand, leaving nothing out and then study what has been left out in this algorithm and, of what has been left out, what has been used.

## Square Roots

Let's thoroughly handle powers or **exponents**. What follows is the arithmetic of exponents.

$$\begin{aligned} a^2 \cdot a^3 &= aa \cdot aaa = a^5 = a^{2+3} & \text{So } a^n \cdot a^m &= a^{n+m} \\ a^2/a^3 &= aa/aaa = a/a \cdot a/a \cdot 1/a = 1/a = a^{-1} & \text{So } a^n/a^m &= a^{n-m} \\ (a^3)^2 &= a^3 \cdot a^3 = a^6 = a^{3 \cdot 2} & \text{So } (a^n)^m &= a^{n \cdot m} \end{aligned}$$

With multiplication, add exponents. With division, subtract exponents. With powers, multiply exponents. The use of negative exponents here is simply notation:  $1/a^n = a^{-n}$ . Fractional powers are **roots** and all of the above rules apply:

$$\begin{aligned} 2 &= \sqrt{4} = 4^{1/2} \\ 2 &= \sqrt[3]{8} = 8^{1/3} \\ a^{1/2} \cdot a^{1/2} &= a^{1/2+1/2} = a^1 = a \\ a^{2/3}/a^{1/3} &= a^{2/3-1/3} = a^{1/3} \\ (a^{1/2})^{1/3} &= a^{1/2 \cdot 1/3} = a^{1/6} \end{aligned}$$

Don't make any of this harder than it is. You have the three rules above. The rest is arithmetic. Notation-wise  $\sqrt{x}$  is older than  $x^{1/2}$ . The advent of the fractions made many new things possible.

$$\begin{aligned} \sqrt{a} + \sqrt{b} &= \sqrt{a} + \sqrt{b} & \sqrt{a} \cdot \sqrt{b} &= \sqrt{ab} \\ a^{0.61} &= a^{61/100} & a^{-1/2} &= 1/a^{1/2} = 1/\sqrt{a} \\ a^{x/y} &= \sqrt[y]{a^x} \therefore a^{2/3} = a^{7/3} = 3\sqrt{a^7} & m\sqrt{(n\sqrt{a})} &= a^{1/n \cdot 1/m} = a^{1/mn} \\ (p+q)^{(m-n)/2} &= \sqrt{((p+q)^{m-n})} & (c^{m/n})^{p/q} &= q\sqrt{(c^{n \cdot m})^p} \end{aligned}$$

The first one indicates what should be obvious: you can't simplify  $\sqrt{3} + \sqrt{7}$ . The second one reminds you that all powers behave the same way:  $a^2 \cdot b^2 = (ab)^2$ . So  $a^{1/2} \cdot b^{1/2} = (ab)^{1/2}$ . The rest, as I said, is arithmetic. While you should be able to understand and use the radical sign ( $\sqrt{\quad}$ ), parentheses and exponents are much clearer in practice. Note that all these ideas of powers can all be extended to multiple elements:

$$(abc)^n = a^n b^n c^n \therefore (abc)^{1/2} = a^{1/2} b^{1/2} c^{1/2}$$

The following theorems follow from arithmetic, as you could prove for yourself, if you knew the basics of induction proofs. And proof by induction is easily learned; it's almost like a game. I'll let you dig into that on your own, if you are interested. Then you can come back and prove these.

1. If  $a > b$  then  $\forall n \in \mathbf{N}, a^n > b^n$
2. If  $a > b$  then  $\forall n \in \mathbf{N}, 1/a^n < 1/b^n$
3. If  $a = b$  then  $\forall n \in \mathbf{N}, a^n = b^n$
4. If  $a = b$  then  $\forall n \in \mathbf{N}, a^{1/n} = b^{1/n}$
5. If  $a > b$  then  $\forall n \in \mathbf{N}, a^{1/n} > b^{1/n}$
6. For  $\forall a, \forall n \in \mathbf{N}, \exists! b: b = a^{1/n}$  [  $\exists!$   $\equiv$  "exists unique" ]
7. No power or root of a **proper** fraction can be an integer.

The sixth theorem says that roots are unique. "For any  $a$  and for any  $n$  in the natural numbers, there exists a unique  $b$  such that  $b$  equals  $a^{1/n}$ . 2 is the only  $\sqrt[3]{8}$ . Clearly, for even powers,  $b$  and  $-b$  are both roots:  $2^2 = (-2)^2 = 4 \therefore \sqrt{4} = \pm 2$ . But for odd powers,  $-b$  won't work, as in the cube root of 8 above. But  $-2$  is the cube root of  $-8 = -2 \cdot -2 \cdot -2$ .

The seventh theorem says that if you have a proper fraction ( $2/3$ ,  $3/2$ , etc. but not  $4/2$ ,  $3/1$ , etc.), you cannot multiply it by itself any number of times or take any of its roots and never get to an integer. This is a very useful result.

Because the symbols can become so busy, it is easy to forget that exponents are simple. What if you had  $x^{m/n}$  and needed  $x$ ? Well,  $m/n \cdot n/m = 1$  and  $x^1 = x \therefore (x^{m/n})^{n/m} = x$ . You should be able to easily reduce the eighth example above to  $c$  in the same way. It is simply arithmetic with exponents. Because this arithmetic is an extension of number, it works with all number. The symbol  $(\pi)^{\pi}$  is correct and meaningful even if its digital representation is beyond our finite reach.

In order to do more with exponents, we need to investigate their form more deeply. So we turn to the simplest example: the **square root**. Any number times itself is a square. This is from Euclid where, given any line (magnitude), you can construct an actual square on that line (Euclid 1.46). What works for pure geometry works for number. Multiplying a number times itself is sometimes called **involution**. Let's involute thirteen:

$$13 \cdot 13 = 169 \therefore 169 = 13^2$$

So 169 is the square of 13. Going the other way is **taking the square root** or **evolution**. And 13 is the square root of 169:

$$\sqrt{169} = (169)^{1/2} = 13$$

All numbers have squares. But only **perfect squares** have integer square roots. Let me riff on the symbols while you keep in mind what they mean:

$$\begin{aligned} \sqrt{a} \times \sqrt{a} &= a & \sqrt{(a \times a)} &= \sqrt{a^2} = a & \sqrt{ab} \times \sqrt{ab} &= ab \\ (\sqrt{a} \times \sqrt{b})(\sqrt{a} \times \sqrt{b}) &= \sqrt{a} \times \sqrt{a} \times \sqrt{b} \times \sqrt{b} = ab \therefore \sqrt{a} \times \sqrt{b} = \sqrt{ab} \\ \sqrt{(a/b)} &= \sqrt{a}/\sqrt{b} \therefore \sqrt{(25/4)} = \sqrt{25}/\sqrt{4} = 5/2 \end{aligned}$$

While  $5 \cdot 5 = 25$ , there is no number in **N**, **Z**, or **Q** which multiplied by itself equals five. As you now know, no proper fraction times itself can equal an integer.  $\forall n \in \mathbf{N}$ , if  $n$  is not a perfect square (4, 9, 16, ...) then  $n$  is an **algebraic irrational number** and their values can only be approximated. Here we approximate the square root of five:

$$\begin{aligned} (123/55)^2 &= 15129/3025 = 5.00132... \\ (15127/6765)^2 &= 228826129/45765225 = 5.0000000874026... \end{aligned}$$

"Irrational" should probably have been "non-rational" or "not one of the rationals, or **ratios**, in **Q**." But it's too late to fix the naming convention now. Irrationals are not crazy; they are simply not rational. They are called "algebraic" because they are the roots of polynomials with rational coefficients. And, interestingly, a number is only algebraic if you can construct it using pure geometry. So anyone who thinks that algebra and geometry are in any way separate is crazy or, at least, not rational. Studying both branches of mathematics sufficiently will probably cure them. Take this as a hint and study both. Sufficiently.

Using arithmetic we can find the square roots of perfect squares. But we need to use the form of number. Let  $x$  be any natural number, then  $x^2$  is a perfect square. We know that  $x$  is the sum of its parts or  $x = a + b + c + d$  where  $a, b, c, d \in \mathbf{N}$ . Therefore,

$$\begin{aligned} x^2 &= (a + b + c + d)^2 = a^2 + 2a(b + c + d) + \\ &\quad b^2 + 2b(c + d) + \\ &\quad c^2 + 2cd + \\ &\quad d^2 \end{aligned}$$

To get the square root from the perfect square, we reverse this algorithm of multiplication. Given  $x^2$  which we will call  $y$ , we need an  $A: y - A^2 > 0$  that leaves  $y - A^2 > 0$ . Then  $y - A^2 = R_1$  or "remainder one." Then we need  $B: R_1 - (B^2 + 2AB) > 0$  and this  $R_1 - (B^2 + 2AB) = R_2$ . Then we need a  $C: R_2 - (C^2 + 2C(A+B)) > 0$  which gives us  $R_3$ . And we continue on with a  $D, E, F, \dots$  for an  $R_3, R_4, R_5, \dots$  until we either get a square root or some  $R_i$  that is too small to subtract 1 from. And in the latter case, we learn that  $y$  (or  $x^2$ ) is an algebraic irrational number. All we are doing here is beginning with the  $d^2$  in our multiplication above and working our way back up the chain. (Use your mind to confirm this.) Let  $x^2 = y = 2025$ :

$$\begin{array}{r} A = 20 \qquad 2025 \ (20^2 = 400) \\ \qquad \qquad \underline{400} \\ B = 20 \qquad 1625 \ (20^2 + 2 \cdot 20 \cdot 20 = 1200) \\ \qquad \qquad \underline{1200} \\ C = 5 \qquad 425 \ (5^2 + 2 \cdot 5 \cdot (20 + 20) = 425) \\ \qquad \qquad \underline{425} \\ \qquad \qquad 0 \end{array}$$

$$A + B + C = 45 \therefore (2025)^{1/2} = 45$$

We can refine this idea by examining the form of squares. Any  $n \in \mathbf{N}$  ending in  $m$  zeroes will have  $2m$  zeroes in its square  $(200 \cdot 200) = 40000 \therefore \forall n^2 (4, 9, 16, \dots)$  with an even number of zeroes following it  $(400, 90000, 16000000, \dots)$  is a perfect square (of 20, 300, 4000, ...). Also when we choose  $n: A - n^2 > 0$ ,  $n$  must be the largest  $n$  that does so and so on for  $B, C, \dots$  By largest, we mean largest **digit** followed by zeroes. We deal in digits of the root

Now take any number, 76176. Mark its digits by twos from the right 7,61,76.

The nearest square below 76176 is 40000 which is  $200^2$  which makes  $A = 200$  and this is the largest such square we can have:  $A - n^2 > 0$

$$76176 - 40000 = 36176.$$

We want the largest  $B$  so that  $B^2 + 2AB < 36176$ .

$$100^2 + 2 \cdot 200 \cdot 100 = 50000. \text{ No good. } B \text{ needs to be in the tens.}$$

$$\text{Or some } N \cdot 10 \text{ so that } (N \cdot 10)^2 + 2 \cdot 200 \cdot (N \cdot 10) = 10N^2 + 4000N < 36176$$

$$36176/4000 = 9.04\dots \text{ (4000 from previous line)}$$

$$N = 9 \therefore 8100 + 36000 > 36176$$

$$N = 8 \therefore 6400 + 32000 > 36176$$

$$N = 7 \therefore 4900 + 28000 < 36176$$

$$\therefore B = 70 \therefore 36176 - 31900 = 3276$$

At last we need simply a digit  $N: N^2 + 2N(A + B) = N^2 + 540N$  gives the largest  $C < 3276$   
 $3276/540 = 6.06\dots$

$$N = 6 \therefore 36 + 540 \cdot 6 = 36 + 3240 = 3276 = C$$

$$\therefore \sqrt{76176} = A + B + C = 200 + 70 + 6 = 276$$

That was the analysis that was used to create an algorithm for finding the square root of any integer in the days before calculating devices. Here is the basic algorithm with some explanatory notes:

$$\begin{array}{r}
 7,61,76 (200 \\
 \underline{4\ 00\ 00} \\
 2 \cdot 200 = 400) 3,61,76 (70 \\
 \quad \underline{70) 3\ 29\ 00} \\
 2 \cdot 200 = 400) \quad 32\ 76 (6 \\
 \quad 2 \cdot 70 = 140) \quad \underline{32\ 76} \\
 \quad \quad \quad 6) \quad \quad 0\ 276
 \end{array}
 \begin{array}{l}
 (= 200^2) \\
 (= 70 \cdot 470) \\
 (= 6 \cdot 546) \\
 (200+70+6 = 276)
 \end{array}$$

Once we know what we are doing, we can lose the zeroes and the notes-to-self. Left to right, deal with the left-most pair of digits (only 7 here) and then bring the next pair down. As in division, you can bring down another pair if you need them.

$$\begin{array}{r}
 7,61,76 (276 \\
 \underline{4\ \ \ \ .} \\
 47) 3\ 61 \\
 \quad \underline{3\ 29} \\
 546) 32\ 76 \\
 \quad \quad \underline{32\ 76}
 \end{array}$$

You should do a couple of these as an exercise. Try 73441 and 2992900 with roots of 271 and 1730. Clearly, you can drop an even number of zeroes from your square and add back half that many zeroes to your root. You know that you understand this process when you can freely use the format of the last example.

You can easily approximate square roots to any degree of accuracy. We did this above, behind the scenes, with  $\sqrt{5}$ . Let's find  $\sqrt{2}$  to within  $1/57$  so that our answer does not exceed that margin of error:

$$\begin{aligned}
 2/1 \cdot 57^2/57^2 &= 6498/3249 \\
 6400 &= 80 \cdot 80 \quad 81^2 = 6561 \quad 79^2 = 6241 \\
 80/57 &< 6498/3249 = 1/2 < 81/57 \\
 \therefore 80/57 &\text{ is within } 1/57 \text{ and less than } \sqrt{2} \\
 (80/57)^2 &= 1.9698\dots
 \end{aligned}$$

We can approximate square roots using our algorithm as well. Divide the number into periods of two so the units figure is the last digit of a period. The decimal point in the result goes after the number used in the units period.

$$\begin{array}{r}
 \sqrt{1.375} \quad 1,37,5 \\
 \quad \underline{1} \\
 21) 37 \\
 \quad \underline{21} \\
 227) 1650 \\
 \quad \underline{1589} \\
 2342) 6100 \\
 \quad \underline{4684} \\
 \quad \quad \text{and so on}
 \end{array}
 \qquad
 \begin{array}{r}
 \sqrt{0.081} \quad 0,08,10 = 8,10 \\
 \quad \underline{4} \\
 48) 4\ 10 \\
 \quad \underline{3\ 84} \\
 564) 2600 \\
 \quad \underline{2256} \\
 5686) 34400 \\
 \quad \underline{34166} \\
 \quad \quad \text{and so on}
 \end{array}$$



You can double the decimal places in the result at any point by division. So both of these can go from three to six decimal places. The "and so on" in each case is supplied by going one step further in the algorithm and dividing instead of multiplying and subtracting:

$$\begin{array}{r} 23466 \ ) \ 141600 \ ( \ 6.03\dots \ \therefore \ 1.72603 \\ 569204 \ ) \ 2840000 \ ( \ 4.98\dots \ \therefore \ 2.846049 \end{array}$$

In the second case, we had to bring down an extra pair of zeroes. You can **accurately** only double the digits and the last digit may be one too great. We will use this again in a moment.

It is now trivial to find the square roots of three and four digit perfect squares using only your head. Required:  $\sqrt{729}$ . 4 largest square  $< 7 \therefore$  1st digit of root is 2. The square of the second digit ends in 9  $\therefore$  2d digit either 3 or 7 but 3 too small  $\therefore \sqrt{729} = 27$ . Okay. So what if it's not a perfect square? Required  $\sqrt{736}$ . 1st digit still 2  $\therefore 736 - 400 = 336$ . We need an  $N^2 + 2N(20) = N^2 + 40N < 326$ .  $N = 8: 64 + 320 = 384$ .  $N = 7: 49 + 280 = 329$ . We have a first approximation:  $27^2 < 736 < 28^2$  and  $27^2$  is closer to 736. You could refine it from there by division:  $336 - 329 = 7$  and  $7 \div 54 = 0.129\dots \therefore \sqrt{736} \cong 27.129$  (squared = 735.983) The 54 is just the next step in the algorithm (2·27) as in our two examples above. You could do all of this in your head if you were willing to develop your mind to this level.

Let's look at one more way to approximate square roots which is also a way to approximate fractions. It uses **continued fractions** which are interesting in themselves. Because of their relation to real numbers, continued fractions have been considerably developed in mathematics. We'll start by putting 43/105 into Euclid's Algorithm which is our GCF algorithm. We divide the greater number by the lesser:

$$43 \ ) \ 105 \ ( \ 2$$

$$\underline{86}$$

$$19 \ ) \ 43 \ ( \ 2$$

$$\underline{38}$$

$$5 \ ) \ 19 \ ( \ 3$$

$$\underline{15}$$

$$4 \ ) \ 5 \ ( \ 1$$

$$\underline{4}$$

$$1 \ ) \ 4 \ ( \ 4$$

$$\underline{4}$$

$$0$$

Now list the quotients: 2, 2, 3, 1, 4

If we put them in this form:

$$\frac{1}{2 + \frac{1}{2 + \frac{1}{2 + \frac{1}{3 + \frac{1}{1 + \frac{1}{4}}}}}}$$

$$2 + \frac{1}{2 + \frac{1}{2 + \frac{1}{3 + \frac{1}{1 + \frac{1}{4}}}}}}$$

$$2 + \frac{1}{2 + \frac{1}{2 + \frac{1}{3 + \frac{1}{1 + \frac{1}{4}}}}}}$$

$$3 + \frac{1}{1 + \frac{1}{4}}$$

$$1 + \frac{1}{4}$$

$$\frac{1}{4}$$

We have a continued fraction equal to 43/105

We also have a series of:

$$\frac{1}{2}, \frac{1}{2 + \frac{1}{2}}, \dots$$

$$\frac{1}{2}, \frac{1}{2 + \frac{1}{2}}$$

$$\frac{1}{2}$$

and its simplified elements are: 1/2, 2/5, 7/17, 9/22, 43/105.

Note that  $1/2 > 43/105$ ,  $2/5 < 43/105$ ,  $7/17 > 43/105$ ,  $9/22 < 43/105$ . Also

$$1/2 \text{ is within } 1/(2 \cdot 5) = 1/10 \text{ of } 43/105$$

$$2/5 \text{ is within } 1/(5 \cdot 17) = 1/85 \text{ of } 43/105$$

$$7/17 \text{ is within } 1/(17 \cdot 22) = 1/374 \text{ of } 43/105$$

$$9/22 \text{ is within } 1/(22 \cdot 105) = 1/2310 \text{ of } 43/105$$

Finally, no fraction with a numerator and denominator less than one of these can come closer to 43/105 than these do. Before we go on, let's note that if you take our GCF quotients and start with 2 + and use only the 2, 3, 1, 4 as a continued fraction, you get a continued fraction equal to 105/43.

Now we can use this method to approximate square roots. We also get to learn another algorithm which calculates continued fractions. Let  $\sqrt{s} = \sqrt{43}$  which equals 6 and a fraction. Our algorithm has three rows: row a, b, and c. And the first a, b, c are 6, 1, 6. The sixes come from integer part of  $\sqrt{43}$  and we will call it "n" and the 1 is just where row b starts. I will lay out the table and then explain how we fill it up:

a	6		1	5	...							
b	1		7	6	...							
c	6		1	1	3	1	5	1	3	1	1	1

We do it this way: in the second column, the new  $b' = (s - a^2)/b$  or  $(43 - 36)/1 = 7$   
 The new  $c'$  is the integer of the quotient  $(n + a)/b' = (6 + 6)/7 \therefore 1$   
 Then the new  $a'$  is  $b'c' - a = (7 \cdot 1) - 6 = 1$ .

The algorithm repeats itself in this way from one column to the next as you can see from the second column. Keep in mind that we are simply computing a continued fraction in row c. The bottom row is shown as developed up to the point where it begins to repeat after the 3. If we stop here, the first element in row c gives us  $6 +$  and the remaining elements give us our continued fraction of approximate  $\sqrt{43}$ . Its simplified fractional series is  $1/1, 1/2, 4/7, 5/9, 29/52, 34/61, 131/235, 165/296, 296/531, \text{ and } 461/827$ . And the square of  $6^{461}/827$  is  $42.99997\dots$  If you would like to play with this idea, the  $\sqrt{2} = 1$  plus a fraction, row c should look like  $1 | 2 2 2 2 \dots$  You can work out the simplified fractions for yourself.

That's all I have to say about powers and square roots. Now we will investigate the Euclid's very old idea of ratio and proportion and see what has been made of it since his time. At the end of this next chapter, we will look once more at fractions and square roots through Euclid's eyes.

## Ratio and Proportion

Euclid's ratios and proportions had nothing to do with number. They compared magnitudes: length, area, volume. But all of the ideas in Euclid's Book V are true of number as well.

The difference ( $\delta$ ) between 8 and 19 is 11. If we take any other two numbers with the same difference (100, 111) and list them in ascending order

$$8 \quad 19 \quad 100 \quad 111$$

the four numbers are in **arithmetical progression** (A.P.). The outer two are the **extremes** and the inner two are the **means**. In A.P., the sum of the means equals the sum of the extremes:

$$19 + 100 = 119 = 8 + 111$$

This idea is usually applied to a series of numbers where each two, in order, share a **common difference**:

a	a+ $\delta$	a+2 $\delta$	a+3 $\delta$	a+4 $\delta$	a+5 $\delta$	$\delta$
1	2	3	4	5	6	1
3	6	9	12	15	18	3
1.5	2	2.5	3	3.5	4	0.5

The sum of the end terms equals the sum of any two which are equidistant from the ends:  $3 + 18 = 6 + 15 = 9 + 12 = 21$ . If this series ended at 15:  $3 + 15 = 6 + 12 = 9 + 9 = 18$ . We can use this property to find the sum of an A.P. series: sum the first and last terms and multiply by one-half the number of terms.  $(3 + 18) \cdot 6/2 = 21 \cdot 3 = 63$ . If the series ended at 15:  $(3 + 15) \cdot 5/2 = 9 \cdot 5 = 45$ . The A.P. relation is also used to define the **arithmetical mean** (A.M.) of any two numbers a,b:

$$\text{A.M.} = (a+b)/2$$

We can look at all this in general terms:

A.P. series:  $a_i = a_1, a_2, a_3, \dots, a_n$

A.P. series's sum:  $\sum a_i = a_1 + a_2 + a_3 + \dots + a_n = \frac{n}{2} (a_1 + a_n)$  [1]

Prove to yourself that this is also true:  $\sum a_i = \frac{n}{2} (2a_1 + (n-1)\delta)$  [2]

([n] markers, when used as reference, will refer back to the most recent matching tag.)

Given  $a_1$ ,  $n$  and  $\delta$ , we can find  $a_n$ :  $a_n = a_1 + (n-1)\delta$ .

And given  $s = \sum a_i$ ,  $n$ , and  $a_1$ , we can find the common difference:

$$s \cdot 2/n = (a_1 + a_n) \quad \text{(from [1])}$$

$$\therefore (s \cdot 2/n) - a_1 = a_n \quad \text{(we now have } a_n)$$

We go from  $a_1$  to  $a_n$  in  $n-1$  steps

$\therefore$  distance is  $a_n - a_1$

Using both of these we get  $\delta = (a_n - a_1)/(n-1)$

Properly speaking, arithmetic proportion is no more a proportion than irrational numbers are crazy. Recall: 8 19 100 111. If you have \$8 and come up to \$19 you have more than doubled your duckies. But if you go from \$100 to \$111 you have gained a dollar more than a tenth of what you had. We can say this as  $8/19 > 100/111$  and see that the two ratios are not proportional. And we get this idea of one number in relation to another, or the idea of **ratio**, from Euclid. The relation of the length of two lines a, b, Euclid expressed as a:b or "a is to b" and, comparing these to c and d which were in similar relation or ratio, he had a:b::c:d or "a is to b as c is to d." Here the "as" meant "greater than, equal to, or less than." And the magnitudes themselves, unrelated to number, simply showed whether it was greater than, equal to, or less than. Usually, Euclid worked with equal ratios. But he could handle inequalities as well.

But all of this carries over into number. We compare 3 to 6 using  $3/6$  and this is equal to  $1/2$  or  $3/6 = 1/2$  or  $3:6::1:2$ . We and the Greeks are asking, for a and b, "What part of b is a?"  $3:6::1:2$  says that 3 is the same part of 6 as 1 is of 2 which is all  $3/6 = 1/2$  is saying. So what part of 7 is 12? 12 is  $12/7$  of 7 or divide seven into seven parts and take 12, just as we said in fractions. When we have four numbers a, b, c, d:  $a/b = c/d$  then the numbers in this arrangement are **proportional**. The ordering is everything.  $3:6::1:2$  expresses one proportion and  $3:1::6:2$  expresses another. And  $3:2::6:1$  only expresses that  $3/6 < 6/1$ . Euclid didn't do this much.

With an normal, equal proportion a:b::c:d, we use means and extremes to show  $ad = bc$ . The a and d are **extremes**; the b and c are **means**.

$$\begin{array}{ll} 3:6::1:2 & 3 \cdot 2 = 6 \cdot 1 \\ 3:1::6:2 & 3 \cdot 2 = 1 \cdot 6 \\ 3:2::6:1 & 3 \cdot 1 \neq 2 \cdot 6 \quad \therefore 3, 2, 6, 1 \text{ not proportional in this order} \end{array}$$

So whether a:b::c:d or  $a/b = c/d$ , if we maintain  $ad = bc$ , we have a proportion if not an identical one:

$$\begin{array}{lll} a:b::c:d & a/b = c/d & ad = bc \\ b:a::d:c & b/a = d/c & bc = ad \\ b:d::a:c & b/d = a/c & bc = da \end{array}$$

Because, in a:b::c:d, the pairs are proportional, proportion is maintained if you add or subtract the same proportional element to the other:

$$(a-b)/b = (c-d)/d \qquad a/(b-a) = c/(d-c)$$

You can use this with all fraction computations including algebraic ones. The Greeks didn't use negative numbers but we do. And it's the proportion and not the sign that matters.

$$\frac{a+b}{a-b} = \frac{c+d}{c-d} \qquad \frac{3+6}{3-6} = \frac{1+2}{1-2} \qquad \frac{9}{-3} = \frac{3}{-1}$$

And if a:b::c:d then for any m,n:

$$ma:b::mc:d \qquad a:nb::c:nd \qquad a/n:mb::c/n:md$$

and so on. If a:b::c:d and e:f::g:h then ae:bf::cg:dh and a/e:b/f::c/g:d/h. Assign some numbers to these letters and you can prove all this to yourself. Do so if you are in any doubt. Also, if a:b::c:d, we have  $a^n:b^n::c^n:d^n$ .

To show how far this can go, we'll prove a theorem. But first we will confuse you by redefining **homogeneous**. Homogenous is not a bad name; it's an overloaded one. Any time you come across "homogenous" you need to ask "With respect to what?" Last time the terms were homogenous if they had the same literals (letters) to the same powers. So they were homogenous with respect to (wrt) each literal. This time they are homogeneous wrt to the degree of the entire term. We're still paying attention to only the literals and not constants (whether letter constants or number constants). So here we ignore 8, m, and 12, because we are choosing to make the terms homogeneous wrt a, b, c:

4th degree	$8a^2bc$	$mab^3$	aabc, abbb have four elements
5th degree	$12abc^3$	$ma^5$	abccc, aaaaa have five elements

And in this sense, if we add or subtract homogeneous terms, the resulting expression is homogeneous in the same degree.

4th degree	$8a^2bc + mab^3$
5th degree	$12abc^3 - ma^5$

**Theorem** If  $a:b::c:d$  and if from the first two (a,b) any two homogeneous expressions be formed of the same degree and if from the last two (c,d) two other expressions be formed in the same way, the four results will be proportional.

**Proof**

$a:b::c:d \therefore a/b = c/d = (\text{some value } x) \therefore a = bx \text{ and } c = dx$   
 $\therefore 2a^3 + 3a^2b = 2b^3x^3 + 3b^2x^2b = 2b^3x^3 + 3b^3x^2 = b^3(2x^3 + 3x^2)$

Sym.  $2c^3 + 3c^2d = d^3(2x^3 + 3x^2)$

Sym.  $b^3 + ab^2 = b^3(1 + x)$  and  $d^3 + cd^2 = d^3(1 + x)$

Clearly,  $b^3:b^3::d^3:d^3 \therefore b^3(2x^3 + 3x^2):b^3(1 + x)::d^3(2x^3 + 3x^2):d^3(1 + x)$

$\therefore 2a^3 + 3a^2b : b^3 + ab^2 :: 2c^3 + 3c^2d : d^3 + cd^2$

And the same logic can be used for any two pairs of such homogeneous terms. ■

If the two means of  $a:b::b:c$  are equal or  $a/b = b/c$ , this is Euclid's **continued proportion** and our **geometric progression** (G.P.). Here  $ac = b^2$  or  $(a/b)^2 = a/c$ . Continuing the proportion for another ratio adds another power:

$1:2::2:4$	$(1/2)^2 = 1/4$
$1:2::2:4::4:8$	$(1/2)^3 = 1/8$

In ratio  $a:b$ , a is the **antecedent** and b is the **consequent**. If there are n continued ratios and m is the last consequent then  $(a/b)^n = a/m$ . Take  $a:b::b:c::c:d::d:e$ .

Then in numbers, we have:  $a/b = b/c = c/d = d/e$ .

Therefore  $b = b/a \cdot a$  and  $c = c/b \cdot b$ . But  $a/b = b/c \therefore b/a = c/b \therefore c = b/a \cdot b = (b/a)^2 \cdot a$

Sym.  $d = d/c \cdot c$ . But  $d/c = c/b = b/a \therefore d = b/a \cdot c = (b/a)^2 \cdot b = (b/a)^3 \cdot a$

So our G.P. is, if  $r = b/a$ , then series is  $a, b = ar, c = ar^2, d = ar^3, e = ar^4$

Let's do the sum of a G.P. =  $1, r, r^2, r^3$

Note that  $p = p - q + q - r + r - s + s$ . This is a very useful algebra technique.

Required: sum of  $1 + r + r^2 + r^3$

$1 - r^4 = 1 - r + r - r^2 + r^2 - r^3 + r^3 - r^4$

$= (1 - r) + r(1 - r) + r^2(1 - r) + r^3(1 - r)$

$\therefore (1 - r^4)/(1 - r) = 1 + r + r^2 + r^3$

Because any G.P. takes the form  $a, ar, ar^2, \dots$ , its sum  $GP_n$  is simply  $a(1 - r^{n+1})/(1-r)$ . Here's another way to think about it:

$$\begin{aligned} GP_n &= a + ar + ar^2 + \dots + ar^n \\ r \cdot GP_n &= ar + ar^2 + \dots + ar^n + ar^{n+1} \\ \therefore \text{subtracting we get } (1 - r)GP_n &= a - ar^{n+1} \therefore GP_n = a(1 - r^{n+1})/(n - 1) \end{aligned}$$

If we ask ourselves, "What does this mean?", we get:

$$\sum n \text{ terms} = [(first \text{ term}) - ((n+1)^{th} \text{ term})] / (1 - \text{common factor})$$

You can determine for yourself, using only 1, 4, and  $4^9$ , that the first nine terms of  $1 + 4 + 16 + \dots$  sum to 87381.

Let's think about the form of the sum of a G.P. if any number  $a$  or fraction  $a/b$  is greater than one, each power ( $a, a^2, a^3, \dots$ ) is greater than the last. If  $a/b > 1$  then  $a/b = 1 + c$ , for some  $c \therefore (a/b)^2 = (1 + c)^2 = 1 + 2c + c^2 \therefore$  even if  $c$  is very small,  $(a/b)^2 > a/b$ . And  $(1 + c)^3 = 1 + 3c + 3c^2 + c^3$  and so on. So for any  $m \in \mathbf{N}$ , no matter how large,  $\exists n \in \mathbf{N}: (a/b)^n > m$ . If  $a/b = 1$  then all its powers are equal to unity. And if  $a/b < 1$ , you can see that it must decrease with every power of  $n$  it is raised to. If  $a/b < 1$ , then  $b/a > 1$ . Let  $b/a = x$ , then  $a/b = 1/x$ . So as  $x, x^2, x^3, \dots$  get larger,  $1/x, 1/x^2, 1/x^3, \dots$  get smaller. Just as  $\forall m \in \mathbf{R}, \exists n \in \mathbf{N}: x^n > m$ , then  $\forall p \in \mathbf{R}, \exists n \in \mathbf{N}: 1/x^n < 1/m = p$ . Here,  $\mathbf{R}$  is the set of real numbers, rational and irrational.

Where  $a/b > 1$ , we say as  $n \rightarrow \infty, (a/b)^n \rightarrow \infty$ . Nothing ever equals infinity (" $\infty$ ") but this shows that as  $n$  increases without bounds,  $(a/b)^n$  increases without bounds. Symmetrically, if  $a/b < 1, n \rightarrow \infty$  then  $(a/b)^n \rightarrow 0$ . Just as  $n$  will never be infinite (there is always  $n+1$ ) so  $(a/b)^n$  will never reach 0. But as the one increases without bounds, the other decreases without bounds but is never less than 0 if  $a/b > 0$ . If  $a/b < 0$ , then for even  $n, (a/b)^n > 0$  and for odd  $n$ , this is less than zero. This simply comes from  $-1 \cdot -1 = 1, -1 \cdot -1 \cdot -1 = -1$  and so on. But here as  $n \rightarrow \infty, (a/b)^{n+1}$  is closer to 0 than is  $(a/b)^n$ .

Let's go back to  $1 + r + r^2 + \dots$ . Now we see that if  $r \geq 1$ , as  $n \rightarrow \infty, GP_n \rightarrow \infty$  but this need not be true if  $r < 1$ . Consider  $1 + 1/2 + 1/2 + 1/4 + \dots$ . For  $\forall n$ , re-adding the last term makes the sum equal to 2:  $n = 2, 1 + 1/2 + 1/2 = 2; n = 3, 1 + 1/2 + 1/4 + 1/4 = 2$ . But we always add half the last term. So as  $n \rightarrow \infty, GP_n \rightarrow 2$  and as  $n$  is never  $\infty$ , the sum is never quite 2.

This limitation is not true for all  $a/b < 1$ . Consider

$$1 + 1/2 + 1/3 + 1/4 + \dots = 1 + 1/2 + (1/3 + 1/4) + (1/5 + \dots + 1/8) + (1/9 + \dots + 1/16) + \dots$$

Each of these groupings  $> 1/2$ . So this  $GP_n > 1 + 1/2 + 1/2 + \dots + 1/2$  for any finite  $n$ , therefore  $n \rightarrow \infty, GP_n = \sum 1/n \rightarrow \infty$ . But our series,  $1 + r + r^2 + \dots$ , always has a limit when  $r < 1$ . Let the last term in this series equal  $a$ . Then

$$(1 - a)/(1 - r) = 1/(1 - r) - a/(1 - r)$$

from our original sum above of a G.P. Now the terms decrease without limit, therefore as  $n \rightarrow \infty, a/(1 - r) \rightarrow 0$ . But  $1/(1 - r)$  never changes. So the limit  $n \rightarrow \infty$  of  $GP_n \rightarrow 1/(1 - r)$  in this case. With  $1 + 1/2 + 1/4 + \dots, r = 1/2 \therefore 1/(1 - 1/2) = 1/1/2 = 2$ .

Think about these things you have just seen:

$$p = p - q + q - r + r - s + s$$

$$(1 - a)/(1 - r) = 1/(1 - r) - a/(1 - r) \text{ where } a \text{ changes but } 1/(1 - r) \text{ doesn't.}$$

The first one makes a form of number available to you to factor out a  $(1 - r)$  and the second one reveals the form of a particular kind of infinite series.

In  $a::b::c:d$ , we have the equivalent form  $a/b = c/d$ . But  $a/b$  can be less than or greater than  $c/d$ :

1. If  $a > b, c \leq d$ , then  $a/b > c/d$ ;
2. If  $a < b, c \geq d$ , then  $a/b < c/d$ ;
3. If  $a/b = c/d$  and  $a/b > c/x$  then,  $d < x$ ;
4. If  $a/b = c/d$  and  $a/b < c/x$  then,  $d > x$ ; and
5. If  $a/b < c/d$ , then  $a/b < (a + c)/(b + d) < c/d$

The first four simply state the form inequalities take. The fifth is important enough to deserve a proof as explanation:

### Proof of #5

$$x < y \quad \therefore x = (m + n)/(m + n) \cdot x = (mx + nx)/(m + n)$$

$$\text{Sym. } y = (my + ny)/(m + n)$$

$$\therefore (mx + nx)/(m + n) < (mx + ny)/(m + n) < (my + ny)/(m + n)$$

$$\therefore x < (mx + ny)/(m + n) < y \quad [1]$$

$$\text{Let } a/b = x, c/d = y \quad \therefore a = bx, c = dy$$

$$\therefore x < (bx + dy)/(b + d) < y \quad (\text{by } [1])$$

$$\therefore a/b < (a + c)/(b + d) < c/d \quad \blacksquare$$

Further, take any whole numbers or fractions  $p, q$ . If  $a/b < c/d$  then

$$a/b < (ap + cq)/(bp + dq) < c/d$$

which you should prove to yourself by the logic of the last proof. Then you can see what algebraical fractions reveal:

1. The value of  $(1 + x)/(1 + x^2)$  is between 1 and  $x/x^2 = 1/x$ ;
2.  $(ax + by)/(ax^2 + b^2y^2)$  is between  $1/x$  and  $1/by$ ;
3.  $(a + b)/2 = (a + b)/(1 + 1)$  and so is between  $a$  and  $b$ ; and
4. If  $(a+b+c+d)/(p+q+r+s) = k$ , then the above can be used to show that  $k$  is less than the maximum and greater than the minimum of  $a/p, b/q, c/r$ , and  $d/s$ .

The commonest context of proportion in schools is usually called the **Rule of Three**.

If 22 yards of cloth costs 20.80, what does 156 yards cost?

$$a::b::c:d$$

$$22 : 20.80 :: 156 : x$$

$$22x = 20.8 \cdot 156$$

$$x = (20.8 \cdot 156)/22 = 147.49$$

Sym., if 22 yards costs 20.80, how many yards can you get for 50.00?

$$\begin{aligned} a:b::c:d \\ 22 : 20.8 :: x : 50 \\ 20.8x = 22 \cdot 50 \\ x = (22 \cdot 50)/20.8 = 52.88 \end{aligned}$$

Here, order is important and we keep our apples and oranges separate. In both cases:

$$a/b = c/d = \text{yards/money}$$

But sometimes the fruit all looks alike. If you have 4000 goombahs in capital gains, what do you pay for tax if the rate is 0.36 goombahs on the goombah? Every fruit is a goombah here. But some are cash and some are taxes:  $1 : 4000 :: 0.36 : x$ . Here cash : cash :: rate : rate. Rates of work or travel are similar. How long will it take 13 men to do what 45 men do in 10 days?

$$\begin{aligned} 13 : 45 : x : 10 \\ x = 130/45 = 2.9 \end{aligned}$$

and this is clearly wrong. Why? Go back to the definition of proportion. We work in number with  $a/b = c/d$  and this comes from  $a:b::c:d$ . And that **means** "a is to b as c is to d" and the "as" **means** "less than, equal to, or greater than." So as  $13 < 45$  then  $10 < x$  and we still need men:men::days:days:

$$\begin{aligned} 13 : 45 :: 10 : x \\ x = 450/13 = 36.6 \end{aligned}$$

So why not  $13 : x : 10 : 45$ ? This is men : days : days : men and when you solve you get:

$$x \text{ days} \cdot \text{days} = \text{men} \cdot \text{men} \Rightarrow x \text{ days} = \text{men}^2/\text{days}$$

where the last and actual solution gives:

$$x \text{ days} = (\text{men} \cdot \text{days})/\text{men} = \text{days}$$

Mathematics is actually meaningful. The question "How long?" is answered in "days" not in "square men per day," whatever those are.

This idea of proportion can be extended to what has been called the **Double Rule of Three** or the **Rule of Five** and probably other things equally unhelpful. If 5 men can make 30 yards of cloth in 3 days, how long will it take 4 men to make 68 yards? (Imagine people actually making something by hand. And then realize that what they made was better than anything you can get now. The original blue jeans were made of 16oz/yd material. Good luck finding 16oz now. But I digress.) The question here is "What is a yard of cloth in man days?" One man does  $1/5$  of 30 by hypothesis (or "problem statement") or 6 in 3 days or 1 yard in  $1/2$  day.  $\therefore$  68 yards is 34 man days. 34 divided by 4 men is  $17/2$  or  $8\frac{1}{2}$  days. And given this, we can ask "How many yards will 6 men make in 12 days?" and know that, as one man makes 24 yards in 12 days, then 6 men will make  $6 \cdot 24 = 144$  yards in the same time. But there is a little algorithm for these kinds of problems where you have five data points and need the sixth.



In each of the earlier examples, the given data is on the top line. The required data is on the bottom line, with each type (men, yards, days) under the same type in the given data. Then you draw those nice curves. The result is the product of the three data curve divided by the product of the two data curve.

$$(5 \cdot 68 \cdot 3) / (4 \cdot 30) = 17/2 = 8\frac{1}{2}$$

$$(6 \cdot 30 \cdot 12) / (5 \cdot 3) = 144$$

To figure out why this works, you can play with the idea of extending a proportion:

a::b::c:d::e:f

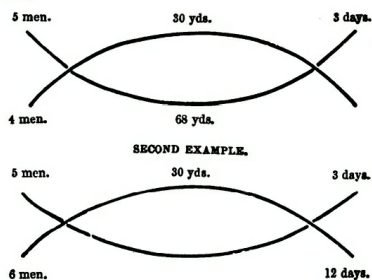

You'll see what is going on pretty quickly. Even if we are bored by commercial and financial applications of mathematics (and we are), let's look at the idea of **interest**. Percentages and exponential growth apply to bamboo groves and human populations as well as to money. These ideas will be found to be fundamental.

Suppose it is required to take 7 parts of 40 from 16. This is to divide 16 into 40 parts and take 7 or  $16/40 \cdot 7 = 14/5$ . Or suppose you need 13 parts out of 100 from 3 hours 27 minutes 48 seconds:

$$((3 \cdot 60 + 27 \cdot 60 + 48) \cdot 13) / 100 = 40521/25$$

This is all about taking some fractional part of a whole. It is also sometimes necessary to ask what fraction one sum is of another in terms of how many parts of 100 must be taken from the second to make the first. This is to ask what percent the first is of the second. What percent is 23 parts out of 56 of any sum? This is

$$(23 \cdot 100) / 56 = 575/14 = 14\frac{1}{14}\%$$

Sym., 16 parts of 18 is  $(16 \cdot 100) / 18 = 88\frac{8}{9}\%$  and 2 parts out of 5 is  $(2 \cdot 100) / 5 = 40\%$ . Here we can see we are converting to parts of one hundred so that  $40\% = 0.4$  therefore  $88\frac{8}{9}\% = (88\frac{8}{9}) / 100 = 0.410714$ . The percent sign means " $\times 1/100$ " which makes the **percentage** two decimal places bigger, as in  $0.4 = 40\%$

If something 10ft tall grows 40% per year, it is 14ft tall after one year and  $14 \cdot 140 / 100 = 19.6$ ft after two years. Here the 140 means it keeps 100% of its size and adds 40% = 140% = 140/100. With money, **simple interest** is a one-time rate added to the total. Best anyone can tell, simple interest has not occurred since the Middle Ages, when those users you've heard about actually charged far less interest than any modern credit card corporation. Its formula is

$$\text{Interest} = \text{Principal} \times \text{rate} \times \text{time}$$

$$I = P \times r \times t = \text{Pr}t$$

So if you borrowed \$3000 at 7% for 1/2 year on the Planet of No Greed, your interest is:

$$3000 \times 7/100 \times 1/2 = \$105$$

When they talk about the "amount" of a loan, this is Principal + Interest = Amount = S:

$$S = P + Prt = P(1 + rt)$$

They used to tweak the variables in these formulae to squeeze more money out of the borrower. And then someone invented **compound interest** and the real squeeze was on. This is where the principal is increased by the rate of interest at the end of each and every interest term. For credit cards, this is at least monthly, perhaps hourly. (And making the minimum payments will **never** decrease the principal.)

But compound interest is also the mathematics of exponential growth. Let's say you have something 100ft tall that grew 4% exponentially every 3 months. How much would it grow in a year? This much:

$$\begin{aligned} & 100(1 + 0.04/4)(1 + 0.04/4)(1 + 0.04/4)(1 + 0.04/4) \\ & = 100(1 + 0.04/4)^4 = 100 \cdot 1.0406 = 104.6 \end{aligned}$$

In money terms, this is

$$S = P(1 + r_p/p)^{pt}$$

where S = amount, P = principal,  $r_p$  = % rate, t = time, and p = compound period. So let's journey again back to the past when people put their money into savings accounts and ask: "What is the amount after 3 years if \$700 is deposited at 3.25% compounded every six months?"

$$S = 700(1 + 0.0325/2)^{2 \cdot 3} = 700(1 + 0.0325/2)^6 = 771.08$$

Nowadays, banks charge negative interest rates to encourage you to put your money in the stock markets where they have a better chance of winding up with it than you do. We will come back to this idea (of exponential growth, if not injustice) when we have more tools. Some other money things which are extensions of proportions can be useful.

Suppose you are a pirate king and want to divide 100 doubloons among three people in shares of 6, 5, and 9. Or, for every 6 doubloons A gets 6, B gets 5, and C gets 9. If we divide 100 into  $6 + 5 + 9 = 20$  parts A gets  $(100 \cdot 6)/20 = 30$  doubloons and you can hone your pirate skills by proving that B and C get 25 and 45 each.

After this, being frugal pirates, A, B, and C invest together in some early railroad scheme. A supplies 250 doubloons, B 130, and C 45 and they make 1000 on their investment by getting out just before the pyramid scheme crashes.  $250 + 130 + 45 = 425$ . So A gets  $(1000 \cdot 250)/425 = 588.24$  doubloons, more than doubling his investment. And you can do the math for B and C.

Or, let's say that A, B, and C invest together but for different periods of time. A puts in 3 doubloons for 6 months in a fruit-stand venture. B does 4 doubloons for 7 months and C does 12 for 2. If we consider these as  $3 \cdot 6$  months = 18 months for A and so forth for B and C, we can divide into  $6 \cdot 3 + 4 \cdot 7 + 2 \cdot 12 = 18 + 28 + 24 = 70$  parts and A, B, C get 18, 28, 24 parts respectively or A gets  $(18 \cdot 100)/70 = 25.71\%$  of the profit and you can figure out how much the others got for helping their peg-legged fellow-worker open a fruit stand for his retirement. Having become wise in the ways of proportions and pirates, let us reconsider fractions.

Consider  $7/9$ .

1. The ninth part of seven or divide 7 into 9 parts and take 1; or
2. Seven ninths of a unit or divide one into nine parts and take seven; or
3. The fraction of which 7 is to 9 or 7 is 7 ninths of 9; or
4. The times and parts of a time (here, only parts) in which 7 contains 9 or 7 contains seven ninths of 9; or
5. The multiplier which turns nines into sevens:  $7/9 \times 81 = 7/9 \times 9 \times 9 = 7 \times 9 = 63$ ; or
6. The ratio of 7:9; or
7. The ratio altering a number in the ratio of 9 to 7 or from above: 81:63:9:7; or
8. The fourth proportional of 9, 1, and 7 or  $9:1::7:\frac{7}{9}$ .

Consider  $\frac{2^1/2}{4^3/5}$

1. The  $4^3/5$  part of  $2^1/2$  is  $25/46$ ; and
2. The fraction itself is  $25/46$  of 1; and
3.  $2^1/2$  is  $25/46$  of  $4^3/5$ ; and
4.  $2^1/2$  contains  $4^3/5$   $25/46$  of a time; and
5. This is the number that turns 46s into 25s; and
6. This is the ratio of 25:46 which alters a number in the ratio of 46 to 25; and
7. This is the fourth proportional of  $4^3/5$ , 1, and  $2^1/2$ .

So if  $2^1/3$  yards of something costs  $3^1/2$  somethings, what does 1 yard cost? From the above, we have  $2^1/3 : 1 :: 3^1/2 : x$  or  $x = (3^1/2)/(2^1/3) = 3/2$

## Combinatorics

I don't really like combinatorics. For one thing, it's been around since Pascal and Fermat and if there is a standard notation, I haven't found it. Combinatorics is essential to probability theory; I dislike and avoid probability theory (and statistics). So I would skip combinatorics if I could. But it pops out at you in many improbable and non-statistical places. So I will give you De Morgan's take on combinatorics as painlessly as I can because it really is worth knowing.

Let's say we have 6 counters: a, b, c, d, e, f and we are asked to take any 3. We take a, f, and c. And we denote this **acf** and call it a **combination** (comb) of 3 from 6. And we will denote this **C<sub>3|6</sub>** which is not standard notation. But then, what is? A combination is only concerned with what things got chosen so we can list them in order: acf. But we can also have a **permutation** (perm) denoted **P<sub>3|6</sub>** and there are 6 perms of a, c, and f which you can work out for yourself.

Given our a, b, c, d, e, f, we can take 6 perms of 1 counter or P<sub>1|6</sub>: a, b, c, d, e, or f. P<sub>2|6</sub> can be obtained by combining each of P<sub>1|6</sub> with each of the others in turn:

ab ac ad ae af  
ba bc bd be bf  
and so on

giving 6 rows of 5 combs or  $6 \cdot 5 = 30$  perms of 2 things taken from 6 things. Each perm is, in fact, a comb and I said "6 rows of 5 combs" both to point this out and to show how confusing combinatorics can be when the author is careless with his nouns. From this point, if we're talking about perms, I won't use combs and I would like all other authors of math texts to follow my lead. You can actually tell that we are talking about perms here, no matter what a careless author calls them, because we **had** ab and we **also took** ba. But as a humanist mathematician, it is actually my job to make things easier and clearer for you, inhumanist authors notwithstanding.

We could take each of our P<sub>2|6</sub>, where for each of the 30 (ab), we could produce 4 more (abc, abd, abe, abf) and  $6 \cdot 5 \cdot 4 = 120$  perms of P<sub>3|6</sub>. Sym. we have  $6 \cdot 5 \cdot 4 \cdot 3 = 360$  for P<sub>4|6</sub> and  $6 \cdot 5 \cdot 4 \cdot 3 \cdot 2 = 720$  for P<sub>5|6</sub> and 720 for P<sub>6|6</sub>. And you should work out for yourself why P<sub>n-1|n</sub> and P<sub>n|n</sub> are always the same.

In general terms, if we have n counters the perms of

1 are n  
2 are  $n(n-1)$   
3 are  $n(n-1)(n-2)$   
and so on.

So P<sub>4|12</sub> are  $12 \cdot 11 \cdot 10 \cdot 9 = 11880$ . But what if, instead of a - f, we had a, a, a, b, c, d, like three mice, a cat, a dog, and a wolverine. If the a's were distinct, we could have  $3 \cdot 2 \cdot 1$  perms of them. So in calculating perms here of some n of six, we must remove the  $3 \cdot 2 \cdot 1$  which are not distinguishable. So P<sub>4|6</sub> =  $(6 \cdot 5 \cdot 4 \cdot 3) / (3 \cdot 2 \cdot 1) = 6 \cdot 5 \cdot 2 = 60$ . And if we had a, a, a, b, b, c this would be  $(6 \cdot 5 \cdot 4 \cdot 3) / (3 \cdot 2 \cdot 2) = 6 \cdot 5 = 30$  where we count down from 3 for the 3 a's and from 2 for the 2 b's and we don't bother writing the ones down because what's the point?

We use this same idea when we want to find combinations instead of permutations. We get the product of the number of objects taken as perms and divide by the possible duplicates (dupes) because the perms give us ab and ba, but in combs, ba is a dupe of ab. You get the idea. So  $C_{4|6}$  is  $(6 \cdot 5 \cdot 4 \cdot 3)/(1 \cdot 2 \cdot 3 \cdot 4)$ . In the denom here, the 2 gets rid of every yx for every xy; the 3 does the same for perms of every xyz, and so forth. I find this confusing if I try to imagine how it actually works. The easiest way to see how it works is to take a small C like  $C_{3|4}$  and, using a, b, c, d, work it out carefully on paper. After that, you can let C be a black box and just run the numbers:  $C_{3|6} = (6 \cdot 5 \cdot 4)/(1 \cdot 2 \cdot 3) = 20$  and so on.

Knowing this much, I could tell you that the cafeteria has 10 items to eat, that you can select any 4, and ask you how many combs there are of delicious American high-school food. But what if there were 4 vegetables, like green bean jello (they still serve that, right?) and you have to take 2 veggies. How many combs now? First consider that some people are gluttons for punishment and would take 3 or even 4 veggies. And then consider that we must somehow separate veggies from actual food. And then we must ask ourselves, how much of all this we can pack into one C fraction. If you will give the following example enough thought, you will have a pattern that will handle all these kinds of questions on your GRE exams.

We need to handle combs with 2, 3, and 4 veggies or 3 possibilities. We have 4 veggies and 6 edibles or 2 groups. Long story short: we need a separate fraction for every possibility. But, clearly, the groups have to be on every fraction. Here's how we set it up:

We calculate each possibility:

$$\begin{aligned}(4 \cdot 3 \cdot 6 \cdot 5)/(1 \cdot 2 \cdot 1 \cdot 2) &= 90 \text{ from 2 veggies, 2 edibles, separated both top and bottom} \\ (4 \cdot 3 \cdot 2 \cdot 6)/(1 \cdot 2 \cdot 3 \cdot 1) &= 24 \text{ from 3 veggies, 1 edible, ditto on separation} \\ (4 \cdot 3 \cdot 2 \cdot 1)/(1 \cdot 2 \cdot 3 \cdot 4) &= 1 \text{ from some kind of vegan death wish, straight up comb}\end{aligned}$$

Then we add the results of the possibilities:  $90 + 24 + 1 = 115$ .

Note that  $C_{x|n} = C_{n-x|n}$  and you can work out  $C_{7|10}$  and  $C_{3|10}$  in their fractions to see how this works. So you can always use the smallest of x and n-x unless you are the kind of person who would eat all four vegetables (gaak!) when you could have done something far easier.

By the same reasoning with perms, you could have n boxes, say 4, and each could have a number of counters in it, say 5, 7, 3, 11 and you can take one counter from each box (ignoring the order of boxes) in  $5 \cdot 7 \cdot 3 \cdot 11$  ways. If the order of boxes matters, this can be done in  $4 \cdot 3 \cdot 2 \cdot 1 \cdot 5 \cdot 7 \cdot 3 \cdot 11$  ways. So let's ignore the order of boxes. If you take 2 from box 1, 3 from box 2, 1 from box 3 and 3 from box 4, you can do this in

$$(5 \cdot 4)/2 \cdot (7 \cdot 6 \cdot 5)/(2 \cdot 3) \cdot 3 \cdot (11 \cdot 10 \cdot 9)/(2 \cdot 3)$$

ways, which is easier to understand once you realize we've dropped the ones in the denoms. If the order of drawings from boxes matter but not the order of the boxes, this becomes

$$5 \cdot 4 \cdot 7 \cdot 6 \cdot 3 \cdot 11 \cdot 10 \cdot 9$$

ways. And if the order of the boxes matters, just multiply either of the last two results by

$$4 \cdot 3 \cdot 2 \cdot 1.$$

And if any of this makes you say, "Whaaaaat?", you just have to work it out with small examples. Very little about combinatorics is "self-evident".

If you have  $x$  **distinguishable** counters, you can distribute them into  $n$  boxes in  $x^n$  ways. If counters and boxes don't matter at all to you, you can do nothing in only one way. And, believe it or not, this fact will arise again in unexpected places -- but not for a while.

If we consider summing integers to make integers and count  $a+b$  and  $b+a$ , there are  $2^{n-1}$  ways to build  $n$ . To build

1	$2^0$	1
2	$2^1$	1+1 2
3	$2^2$	1+1+1 1+2 2+1 3

To sum each  $n$  with odd numbers, if  $a$  is the number of ways to build  $n$  and  $b$  is the number of ways to build  $n+1$ , then  $a+b$  is the number of ways to build  $n+2$ . Every way to build 12 is either a 10 with 2 added or an 11 with 1 added. For 1, we have 1. For 2, we have 1+1. For 3: 1+1+1 and 3. You can do 5 to  $\infty$ , which is not a number -- as Ludwig Wittgenstein said, "Infinity is an adverb." When you are done, we have the series, based on ways of building each  $n$  from odd  $n$ , of 1, 1, 2, 3, 5, 8, 13, ... where  $a_n = a_{n-1} + a_{n-2}$ . In these series:

1)	1 1 1 2 3 4 6 9 13 19 ...
2)	0 1 0 1 1 1 2 3 4 5 ...

after the 3d term in #1,  $a_n = a_{n-1} + a_{n-3}$  and in #2,  $a_n = a_{n-2} + a_{n-3}$ . In #1, show that  $a_n$  is the number of ways to sum  $n$  with numbers which when divided by three leave remainder 1 and that #2 is the same for remainder 2. Or never show your face around here again.

[Let me clarify the idea that "infinity is not a number." Until Cantor, it was not a number. You had the finite numbers and you had infinity, as in "1, 2, 3, ...". Cantor closed the set of natural numbers and made this set the first infinite cardinal number. He then "proved" that the reals were the next cardinal number. I say "proved" because many mathematicians disagreed, Hilbert and Poincare among them. Today, it is generally accepted that these two cardinals are valid. The first is "countable" and the second is "uncountable." And this is as far as most mathematicians will go. As soon as you close an infinite set (or claim to have "all of it") the Hydras of Contradiction raise their ugly heads, beginning with the Axiom of Choice and its equivalents. So most people are willing to put one foot out over the edge of the infinite numerical cliff because it's kind of cool. But they are reluctant to put the other foot out there. Those who do, of course, never hit bottom -- so they're cool, too. In any case, infinity cannot be treated as a number in the way this text treats of numbers.]

We can sum  $n$  from  $m$  numbers. Let's sum 12 with 7 numbers. We have 12 ones and 6 possible partitions:

$$1 | 1 | 11 | 11 | 11 | 1 | 11 | 11$$

This quickly becomes: "How many combinations of 6 can be made from 11 possible placements," or  $C_{6|11} = 462$ . Here different orderings ( $a+b$ ,  $b+a$ ) count as different ways. To look at this in a general way, we denote the number of ways to make  $m$  things from  $n$  things  $M_n = n \cdot (n-1) / 2 \cdot (n-2) / 3 \cdots (n-m+1) / m$ . Of course, this is  $C_{m|n}$  in a different form but this form comes up again outside combinatorics; so we keep them separate.

Let's sum 12 with 7 numbers but allow 0 as a number. This is the same number of ways as building  $12 + 7 = 19$  without 0, if you think about it (so think about it until you see why this is true). Take any sum to 12, using 0 or not, add one to each number and you have 19.

As  $6_{11}$  was the number of ways to build 12 using 6 numbers without 0,  $6_{18}$  is the number of ways to build 12 with 6 numbers allowing 0.

And this is exactly the number of ways to distribute  $n$  **undistinguishable** counters in  $m$  boxes. Using  $M_n$  notation, to distribute  $c$  counters in  $b$  boxes, there are  $(b-1)_{b+c-1}$  ways if boxes can be empty. But if every box must have at least one counter, this becomes  $(b-1)_{c-1}$  or if at least 2 counters:  $(b-1)_{c-b-1}$ , and if 3:  $(b-1)_{c-2b-1}$ . And to see how this works, go get a few coffee cups and a small number of beans and fiddle around until the truth dawns upon your waiting consciousness.

So the number of ways  $m$  odd numbers sum to  $n$  is the same number of ways  $m$  even numbers, including 0, sum to  $m-n$  and the same number of ways any  $m$  numbers, including 0, sum to  $\frac{1}{2}(n - m)$ . You can see why I wish I could ignore combinatorics.

Let's take 5 counters from 12 and set one of the 12 (A) apart as distinct from the rest. Then every comb of 5 either does have A or  $C_{4|11}$ , as the number of ways to take 4 from 11, or does not have A or  $C_{5|11}$ . Therefore,  $5_{12} = 5_{11} + 4_{11}$  or  $C_{m|n} = C_{m|n-1} + C_{m-1|n-1}$ .

There is only one way to take all or none so  $C_{1|n} = C_{n|n}$  (=  $C_{n-1|n}$  as before). If  $m > n$ ,  $C_{m|n} = 0$  because it's impossible to do that kind of thing. If we make rows of  $n$  and columns of  $m$ , a  $C_{m|n}$  or  $M_n$  table is:

	0	1	2	3	4	5	6	...
1	1	1	0	0	0	0	0	0
2	1	2	1	0	0	0	0	0
3	1	3	3	1	0	0	0	0
4	1	4	6	4	1	0	0	0
5	1	5	10	10	5	1	0	0
6	1	6	15	20	10	6	1	0
								...

This is Pascal's triangle again. If you consider the "-1" column as all zeroes, you can build this triangle with addition. Each number is the sum of the previous row's numbers above it and above and to the left of it. So row 1 is 0+1 and 1+0. The values of the rows are also  $C_{m|n}$  or  $M_n$ , e.g. column 4, row 5 is  $C_{4|5} = 5 = (5 \cdot 4 \cdot 3 \cdot 2) / (1 \cdot 2 \cdot 3 \cdot 4)$ . As if this wasn't enough, if we sum the rows, we get the series: 2, 4, 8, 16, ... where  $a_n = 2^n$  and therefore:

$$2^n = C_{0|n} + C_{1|n} + \dots + C_{n|n} = \sum C_{i|n} [i:1-n]$$

If we produce  $(1 + x)^2 = 1 + 2x + x^2$ , the coefficients (coeff) are row 2. The coeff of  $1 + x$  are row 1. The coeff of  $(1 + x)^n$  are row  $n$ . Or

$$(1+x)^n = 1 + nx + n \cdot (n-1) / 2 \cdot x^2 + n \cdot (n-1) / 2 \cdot (n-2) / 3 \cdot x^3 + \dots$$

$$\therefore (x + a)^n = x^n + C_{1|n} a x^{n-1} + C_{2|n} a^2 x^{n-2} + C_{3|n} a^3 x^{n-3} + \dots + C_{n|n} a^n$$

If we turn the triangle on its side (or something), so that each entry is the sum of the digit above and all those to the left of it we get:

[Cont'd next page.]

1	0	0	0	0	If we multiply by a before	$x^3$	$x^2$	$x^1$	$x^0$	0
1	1	1	1	1	each addition, we have the	1	a	$a^2$	$a^3$	$a^4$
1	2	3	4		powers of $(1+a)$ and if for	1	2a	$3a^2$	$4a^3$	
1	3	6			$(1+a)^n$ , we use descending	1	3a	$6a^2$		
1	4				powers of x for, say $(1+a)^3$ ,	1	4a			
1					we can read off $(1+a)^3$ as	1				
						$x^3 + 3ax^2 + 3a^2x + a^3$ .				

And we can extend this to calculate:  $p(x+a)^3 + q(x+a)^2 + r(x+a) + s$  [1]

$x^3$	$x^2$	x	1	$x^2$	x	1	x	1	x
p	0	0	0	q	0	0	r	0	s
p	pa	$pa^2$	$pa^3$	q	qa	$qa^2$	r	a	
p	2pa	$3pa^2$		q	2qa		r	ra	
p	3pa			q			r		
p									

$$\begin{aligned} \therefore [1] &= px^3 + 3pax^2 + 3pa^2x + pa^3 + qx^2 + 2qax + qa^2 + rx + ra + s \\ &= px^3 + (3pa + q)x^2 + (3pa^2 + 2qa + r)x + (pa^3 + qa^2 + ra + s) \end{aligned}$$

And this is probably the quickest way to do such a calculation. I'll show you another way when we get to using other bases than 10 for positional notation.

As a final application (puzzle?) of this Pascal's Triangle idea, we can take  $2x^5 + x^4 + 3x^2 + 7x + 9$  and substitute  $(x + 5)$  for  $x$ :

$2x^5$	$x^4$	$0x^3$	$3x^2$	$7x$	9
	1	0	3	7	9
2	11	55	268	1397	6994
2	21	160	1078	6787	
2	31	315	2653		
2	41	520			
2	51				
2					

The result is:  $2x^5 + 51x^4 + 520x^3 + 2653x^2 + 6787x + 6994$ . If I were a cruel man, I would go on to the next chapter and leave you on your own to puzzle this out. Here's a piece of the pattern:

$$\begin{aligned} 11 &= 2 \cdot 5 + 1 & 55 &= 11 \cdot 5 + 0 & 268 &= 55 \cdot 5 + 3 \\ 21 &= 2 \cdot 5 + 11 & 160 &= 21 \cdot 5 + 55 \\ 31 &= 2 \cdot 5 + 21 \end{aligned}$$

That's all the help you get here. Let's turn to Number Theory which is another way to say "properties of number" or "the consequences of the form of number."



## Number Theory

### Proposition (Prop.) 1

If  $b/a$  in lowest terms, there is no  $a' < a$  or  $b' < b$ :  $b'/a' = b/a$

**Proof** (by *reductio absurdam* or contradiction)

Assume such an  $a'$  and  $b'$  exist (in order to show it leads to a contradiction).

Then  $b'/a' = b/a$ .

Using Euclid's Algorithm:

$$\begin{array}{r}
 \text{a) } b \text{ (m)} \qquad \qquad \qquad a' \text{ (m')} \\
 \underline{ma} \qquad \qquad \qquad \underline{m'a'} \\
 \text{c) } a \text{ (n)} \qquad \qquad \qquad c' \text{ (n')} \\
 \underline{nc} \qquad \qquad \qquad \underline{n'c'} \\
 \text{d) } c \text{ (r)} \qquad \qquad \qquad d' \text{ (r')} \\
 \underline{rd} \qquad \qquad \qquad \underline{r'd'} \\
 \text{e} \qquad \qquad \qquad \text{e'}
 \end{array}$$

$$b/a = b'/a' \text{ (hyp)} \therefore m = m'$$

$$b/a = m + c/a \text{ and } b'/a' = m' + c'/a' \therefore c/a = c'/a'$$

$$\text{Sym. } d/c = d'/c' \text{ and } c' < c \therefore d' < d$$

$\therefore$  RHS algorithm will terminate in 1 before the LHS

$$\text{Let } e' = 1 \therefore e > 1$$

$$d/e = d'/e' \text{ (proven)} \therefore d/e = d' \therefore e > 1 \text{ and is a factor of } d$$

$\therefore e$  is a factor of  $a$  and  $b \nmid (a, b \text{ prime to e.o. by hyp})$

$\therefore$  no such  $b'/a'$   $a' < a$ ,  $b' < b$  equal to  $b/a$  exists. ■

Number Theory is whoppingly necessary to mathematics. And you can't have number theory without proofs. The most important thing to learn from proofs is patience. Be patient enough to actually grasp the real truth of each step in a proof. So this is a chapter on both the form of number and the development of patience in your mind.

This proof shows the pattern of proof by contradiction: To prove  $A$ , assume  $\neg A$  (not  $A$ ), and drive that assumption to a contradiction. If it can't be  $\neg A$  then it has to be  $A$  by the Law of the Excluded Middle: It can't not be  $A$  and not be  $\neg A$ ; one must be true. The (hyp) means "by hypothesis" which is everything stated in the proposition. You know that " $\therefore$ " is "therefore." The " $\nmid$ " is the sign of contradiction and its justification immediately follows in parens. The black square means either that the proof is done or that your fellow pirates have declared your death sentence.

### Prop. 2

If  $ab$  divby  $c$  and  $p(b, c)$  then  $a$  divby  $c$ .

(For anyone caught napping, "divby" is laziness for "is divisible by, without remainder" and  $p(b, c)$  is " $b$  and  $c$  are prime to each other, sharing no factors.")

#### Proof

$$\text{Let } ab/c = d \therefore b/c = d/a$$

$$b/c \text{ in lowest terms (hyp)} \therefore \exists \text{ gcm}(a, d) = k \text{ (Prop. 1)} \therefore a = kl, d = km \text{ for some } l, m \in \mathbb{N}$$

$$\therefore b/c = km/kl = m/l \therefore m/l \text{ in lowest terms (or } p(m, l))$$

$$\therefore b = m \text{ and } c = l \text{ (Prop.1)} \therefore a = kc \therefore a \text{ divby } c \quad \blacksquare$$

#### Corollary (Cor.)

If  $p(a, b)$  and  $p(a, c)$  then  $p(a, bc)$

Another thing to learn from proofs is the method each uses to get from its predicates to its conclusion. The method is composed of the same kind of choices you find in algebra. You choose what gets you to where you are going. A corollary is a proposition which you more

or less get for free from the proposition you just proved. If it is absolutely obvious, you get it for free and can just state it. Otherwise, you point out why it is obvious to all but the slow and thick, like myself, adding just enough commentary to accomplish this.

**Prop. 3**

$$p(a,b) \Rightarrow \forall n \in \mathbf{N}, p(a,b^n)$$

(More laziness here: " $\Rightarrow$ " is implication.  $A \Rightarrow B$  is read "If A then B.")

**Proof**

$$p(a,b) \therefore b \nmid \text{divby } a \text{ or any factor of } a \quad (\nmid \text{divby} \equiv \text{"not divisible by, without remainder"}) \\ \therefore b \cdot b \nmid \text{divby } a \therefore b \cdot b \cdot b \nmid \text{divby } a \therefore \text{and so on } \blacksquare$$

This is why no fraction can be made into a terminating decimal fraction if its denom can't be put in a form with factors of 2 and 5. If  $a/b = c/10^n$  then  $c$ , which is an integer, equals  $(a \cdot 10^n)/b$ . So if  $p(a,b)$  then  $b$  must divide  $10^n$  without remainder by Prop. 2.

**Prop. 4**

If  $p(a,b)$  then all multiples of  $b$   $\{b, 2b, 3b, \dots, (a-1)b\}$  have different remainders when divided by  $a$ .

**Proof**

Else let  $n < m < a$  and let  $mb/a$  and  $nb/a$  have the same remainder

$$\therefore mb - nb = (m-n)b \text{ is divby } a \therefore m-n \text{ divby } a \quad \nexists \quad (\text{Since } m-n < a) \quad \blacksquare$$

You have to think	$mb = fa + r$	$nb = ga + r$
proofs out with a	$\therefore mb - nb = fa - ga + r - r$	
pencil in your hand.	$\therefore (f-g)a = (m-n)b \text{ divby } a \quad \nexists$	

Here  $r = r$  by hypothesis and this leads to a contradiction. The  $f$  and  $g$  are smaller than  $m$  and  $n$  because of the remainder. So this is my way of seeing the essence of the proof. Each of us must come to our own individual understanding of a proof. The "Else" is always signal that the proof will be by contradiction.

It follows from this proposition (and this is important) that if a number be reduced to its prime factors ( $360 = 2 \cdot 2 \cdot 2 \cdot 3 \cdot 3 \cdot 5$ ) and if the factors are  $a, b, c, \dots$  ( $2, 3, 5$ ) and the powers  $\alpha, \beta, \gamma, \dots$  ( $3, 2, 1$ ) so that the number is  $a^\alpha b^\beta c^\gamma \dots$  ( $2^3 \cdot 3^2 \cdot 5$ ) that this factoring is **unique**. For any prime number  $p$  which is prime to  $a, b, c, \dots$  is prime to  $a^\alpha b^\beta c^\gamma \dots \therefore \forall p$  not in the factors is prime to  $a^\alpha b^\beta c^\gamma \dots$  which is the number itself.

The number of divisors, including unity of a number  $a^\alpha b^\beta c^\gamma \dots$  is  $(\alpha+1)(\beta+1)(\gamma+1) \dots$  because  $a^\alpha$  gives  $1, a, a^2, a^3, \dots, a^\alpha$  which comes to  $\alpha+1$  divisors and sym. for  $b^\beta, c^\gamma, \dots$ . All the divisors are then one out of each of these sets  $(1 \cdot \beta^2 \cdot \gamma^3 \dots)$ . The number of divisors is then as the combs of counters from boxes  $(\alpha+1)(\beta+1)(\gamma+1) \dots$

If a number  $n$  is divby certain primes ( $3, 5, 7, 11$ ) then  $1/3$  of all number less than  $n$  are divby 3,  $1/5$  by 5, and so on. If we toss out the multiples of 3 less than  $n$ ,  $1/5$  of the remaining numbers are still divby 5, for  $1/5$  of the whole were divby 5, so were  $1/5$  of these removed with the threes, therefore  $1/5$  of the remainder are still divby 5. Because  $1/7$  of all  $m < n$  divby 7,  $1/7$  of all the multiples of 3, 5, 15, are divby 7 So you can remove all multiples of 3 and 5 and  $1/7$  of the remainder are still divby 7. Therefore, of all numbers less than  $n$ ,  $2/3 \nmid \text{divby } 3, 4/5 \nmid \text{divby } 5$ , and so on. In all of this,  $n = 3 \cdot 5 \cdot 7 \cdot 11$  or those factors to **any** exponents.

It follows that the numbers of integers less than  $n$  which are prime to  $n$  if  $n = a \cdot b \cdot c \dots$  (each to any power) is:

$$n \cdot (a-1)/a \cdot (b-1)/b \cdot (c-1)/c \dots = a^{\alpha-1} b^{\beta-1} c^{\gamma-1} \dots (a-1)(b-1)(c-1) \dots$$

Example:  $360 = 2^3 \cdot 3^2 \cdot 5$

$$\text{Divisors} = (3+1)(2+1)(1+1) = 4 \cdot 3 \cdot 2 = 24$$

$$n < 360, \text{ prime to } 360 = 2^2 \cdot 3 \cdot 1 \cdot (2-1)(3-1)(5-1) = 4 \cdot 3 \cdot 1 \cdot 1 \cdot 2 \cdot 4 = 96$$

### Prop. 5

If  $p(a,b)$  then terms  $a, a^2, a^3, \dots$  if divided by  $b$  leave different remainders until the remainder is 1 and then the remainders repeat.

#### Proof

Let  $a \div b$  give remainder  $r \neq 1$ .

Then  $a^2 \div b$  gives same remainder as  $ra \div b$

But it is  $\neq r$  (Prop. 4)  $\therefore a^2 \div b$  gives remainder  $s$

Then  $a^3 \div b$  gives same remainder as  $sa \div b$  which sym. can't be  $r$  or  $s$

$\therefore a^3 \div b$  gives remainder  $t$  and so on

$\therefore$  we get different remainders until remainder 1 occurs

1 must occur as division by  $b$  only gives remainders less than  $b$ : 0, 1, 2, ...,  $b-1$

0 can't occur because  $p(a,b)$

$\therefore$  no more (sometimes less) than  $b-2$  different remainders can occur before 1 occurs ■

If it doesn't occur earlier,  $a^{b-1} \div b$  has remainder 1

For example, in 7,  $7^2, 7^3, 7^4 \div 5$  remainders are 2, 4, 3, 1.

### Prop. 6

$a^m - b^m$  is always divby  $a-b$

#### Proof

$$a^m - b^m = a^m - a^{m-1}b + a^{m-1}b - b^m = a^{m-1}(a-b) + b(a^{m-1} - b^{m-1})$$

So if  $a^{m-1} - b^{m-1}$  divby  $a-b$  so is  $a^m - b^m$

But  $a-b$  divby  $a-b, a^2 - b^2$  divby  $a-b$ , and so on. ■

#### Cor. 1

If  $a, b$  divided by  $c$  leave same remainders, then  $\forall n \in \mathbf{N}, a^n, b^n$  divided by  $c$  leave same remainders because  $a, b$  leaving same remainders means  $(a-b)$  divby  $c$ .

#### Cor 2

$a^m - b^m$  is not divby  $c$  unless  $a^m \div c$  and  $b^m \div c$  leave the same remainders.

### Prop. 7

If  $b$  is prime and  $a \nmid \text{divby } b$ , then  $a^b$  and  $(a-1)^b + 1$  leave the same remainders when divided by  $b$ .

#### Proof

Exercise for the reader: After you have learned the Binomial Theorem later in this text, expand  $(a-1)^b$  using that theorem. Show that when  $b$  is prime, every coeff not equal to unity is divby  $b$ . And this proposition follows.

### Prop. 8

If  $b$  prime,  $p(a,b)$  then  $a^{b-1} \div b$  leaves remainder 1.

#### Proof

From Prop. 7,  $a^b - a$  leaves same remainder as  $(a-1)^b + 1 - a = (a-1)^b - (a-1)$

$\therefore$  remainder of  $a^b - a$  not changed by reducing  $a$  by 1

$\therefore$  this can be done until  $a^b - a = 1^b - 1 = 0$  with remainder 0

$\therefore a^b - a = a(a^{b-1} - 1)$  which is divby  $b$

$\therefore a^{b-1} \div b$  leaves remainder 1 ■

It follows then from  $p(a,b)$  that if we divide  $1, a, a^2, a^3, \dots$  by  $b$ , we get a set of remainders beginning with 1 and remainder 1 occurs absolutely at  $a^{b-1}$  if not before so long as  $b$  is prime. When 1 occurs, the cycle of remainders repeats and 1 is always the start of the cycle. But if  $m < b$  and series is  $m, ma, ma^2, \dots$  then the first remainder is  $m$  and cycles begin with  $m$ . If for  $1, a, a^2, \dots$  the remainders are  $1, r, s, t, \dots$ , these will be  $m, mr, ms, mt, \dots$ . But if the cycle  $1, r, s, t, \dots$  doesn't give all  $n < b$ , then  $m, mr, \dots$  can give other remainders.

All these theorems apply to reducing a fraction to a decimal fraction. If  $p(m,b)$  then  $m/b$  is in lowest terms, and the process is successive divisions of  $m, 10m, 10^2m, \dots$  by  $b$ . This cannot terminate unless some  $10^n$  divided by  $b$  has only factors of 2 and 5 to some exponent. In every other case, we get cycles of remainders:

$$\begin{aligned} 1/7 &= 0.142857142857\dots \\ 1/14 &= 0.07142857142857\dots \\ 1/28 &= 0.03571428571428\dots \end{aligned}$$

In  $m/b$ , the quotient always repeats from the beginning when  $b$  is prime and  $m < b$ . Then number of figures that repeat is either  $b-1$  or a factor of  $b-1$ .

And now for something completely different. When we talk about representing numbers using different bases we call these **scale of notation**. In our positional decimal notation, the positions, right to left, are  $10^0 = 1, 10^1, 10^2, \dots$ . Here, 10 is our **radix** or **base**. But any other radix is possible: decimal = 10, binary = 2, ternary = 3, quinary = 5, duodenary = 12. In all of these, the radix itself is expressed as 10. Then 6 in base 6 is written 10, which is no  $6^0$  digits and one  $6^1$ . So 7 in base 6 is 11 and 35 in base 5 is 120 or  $1 \cdot 5^2 + 2 \cdot 5^1 + 0 \cdot 5^0$ .

To convert 35 in decimal to 120 in quinary, we get another division-like algorithm:

5 ) 35 ( 7 r 0	We continue to divide quotients by the new
5 ) 7 ( 1 r 2	base until the process terminates. Then we
5 ) 1 ( 0 r 1	take the remainders in reverse order.

To understand this, realize that the first division looks for leftover  $5^0$  digits in the remainder, the second division gives us a remainder of leftover  $5^1$  digits, and so on. Now, recall when we used Pascal's Triangle to convert a polynomial in  $x$  to its equivalent in  $(x+5)$ . In a sense, this is changing its base. Here's another way to do that based on this same change-of-base algorithm.

[Cont'd next page.]

We take  $5x^3 - 11x^2 + 10x - 2$  in terms of  $(x-1)$ :

$$\begin{array}{r|l} 5x^3 - 11x^2 + 10x - 2 & x - 1 \\ \underline{5x^3 - 5x^2} & | 5x^2 - 6x + 4 \\ -6x^2 + 10x & \\ \underline{-6x^2 + 6x} & \\ 4x - 2 & \\ \underline{4x - 4} & \\ r 2 & \end{array}$$

We do the repeated divisions as above. At the end, that last quotient, **5**, makes the final element. As a result, the polynomial in terms of the new "base" is

$$\begin{array}{r|l} 5x^2 - 6x + 4 & x - 1 \\ \underline{5x^2 - 5x} & | 5x - 1 \\ -x + 4 & \\ \underline{-x + 1} & \\ r 3 & \end{array}$$

$$5(x-1)^3 + 4(x-1)^2 + 3(x-1) + 2$$

which could then be simplified.

$$\begin{array}{r|l} 5x - 1 & x - 1 \\ \underline{5x - 5} & | 5 \\ r 4 & \end{array}$$

Another way to change bases with numbers is to multiply the leftmost digit by the old radix as expressed in the new scale, add the next digit and repeat:

$$\begin{array}{l} 35 \text{ decimal to quinary} \\ \text{old radix (10) in new scale (5) is } 20 \\ 3 \cdot 20 = (\text{in new scale}) 110 + (\text{next digit in new scale}) 10 = 120 \end{array}$$

None of this radix business is earth-shaking. The polynomial bit can be useful. And it is useful to be able to answer (for yourself) the next two questions:

1. In base 10,  $1/9 = 0.111111\dots$   $2/9 = 0.222222\dots$   $3/9 = 0.333333\dots$  and so on. How does this express itself in other bases? State this in general terms as a principle.
2. In base 10,  $n$  divby 3 if the sum of the digits divby 3 or because  $372 \rightarrow 3+7+2 = 12 \rightarrow 1+2 = 3$  divby 3, then 372 itself divby 3. And  $n$  divby 9 if the sum of the digits is divby 9 or because  $378 \rightarrow 3+7+8 = 10+8 \rightarrow 1+8 = 9$  divby 9 then 378 divby 9 and by extension, 378 divby 3. So in general terms, how does this work itself out in other bases?

## Geometry

De Morgan sent his readers to Euclid for their geometry, just as I do. However, he used one long proof in pure geometry to show the method of proof. So he briefly sets the stage for the study of geometry and provides such geometry as is useful combined with arithmetic. There are already plenty of proofs in this book. Go get your pure geometry proofs from Euclid. Here are the rest of De Morgan's geometric ideas from his *Elements*.

In pure geometry, lines are ideals: length without width or depth. Therefore, no number of lines can make a surface. Plenty of people will tell you otherwise. They are wrong. Zero width plus zero width, performed ever-so-many times, sums to zero width. This may seem trivial but wrong ideas have their consequences. It follows that a dividing line is no part of the division.

Neither are lines composed of points. Points are location without length, width, or depth. They have zero dimension. They mark a spot. So every division of lines by points increases the number of lines. And the shortest line can be divided by as many points as the longest. Here  $AB$  is a finite short line. But we can view the line with  $A$ ,  $E$ , and  $F$  as  $AF(\text{pr})$  or  $AF$  produced indefinitely in the direction of  $F$ . Produce  $AF$  ever so far, for any  $CE$ ,  $CE$  intersects  $AB$  at some  $e$ . Later we will talk about functions but here's a preview.

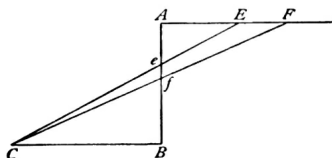

Let  $AB$  be the closed interval  $[0,1]$  and  $AF(\text{pr})$  be the half open interval  $[0, \infty)$ . Then for every  $x$  on  $AB$ , we can view the law of creating a line  $CeE$  as a function  $f: AB \rightarrow AF(\text{pr})$  that maps the  $x$  on  $[0,1]$  to some  $f(x)$  on  $[0, \infty)$ . Infinity being an adverb, we never get there. But if we did,  $CE$  would become  $CB$  or  $f(1) = \infty$ . And in some mathematics, we do consider that parallel lines intersect at infinity. But not here.

Most forms of number in whatever context can be viewed geometrically as well. We will talk about lines, or first degree equations soon. Here we can think about proportions, geometrically, as lines:

**Prop.** If lines  $A:B::P:Q$  then  $\exists!$  (exists unique)  $m, n \in \mathbf{N}$ :  $mA - nB = 0$  and  $mP - nQ = 0$ .

As future exercises at their proper time, you could try to express this proposition geometrically and see what other geometric consequences, if any, apply and also you can try to find some  $f(x): [0,1] \rightarrow [0, \infty)$  for that last example.

All that remains of the Arithmetic section of this book is De Morgan's examples of geometry as used with arithmetic. If you had studied Euclid as you were told to do, you would see that all of this follows from Euclid once you imposed a metric on Euclidean space. And all that means is that you pick some definite length to call unity. For example, if you pick an inch, an inch = 1 and all measurements follow from that choice. It was Kant who said that bit about mathematics being the science of diagrams. I will let you supply the diagrams for the following wherever you need to clarify their meaning.

**Area of a Rectangle**

Multiply the length of adjacent sides.

**Area of a Parallelogram**

||gms have 2 pair of equal and || sides. Multiply base  $\times$  perpendicular ( $\perp$ ) height.

**Area of Trapezius**

These have 2 || sides and 2 not || sides. Multiply either non-|| side by the  $\perp$  from the other non-|| side. You will need to reason this out with a diagram. What determines the height of this perpendicular?

**Area of Triangle**

Let any side be base. Then area is  $\frac{1}{2}$ base  $\times$  height and height is the  $\perp$  from the base to the apex  $\angle$ . Or, halve the sum of the sides, subtract each side separately from this sum, multiply the four results, and area is the square root of this product. Note that twice the area divided by any side is the distance of that side from the opposite angle. And divide the area by  $\frac{1}{2}\sum$ sides to get the radius of the circle inscribed in the triangle.

**Hypotenuse of Right Triangle Given the Two Sides**

Take the square root of the sum of the squares of the sides. You knew this, right?

**Side of Right Triangle Given the Hypotenuse and Other Side**

Take the square root of (hyp + side)(hyp - side)

**Approximate Circumference of Circle Given Radius**

$2 \times$  radius  $\times \pi$  where  $\pi$  can be approximated by  $22/7$  or  $355/113$ . How many decimal places do these approximations go?

**Arc of Circle Sector Given Radius and Angle**

Turn the angle into seconds, multiply by the radius, divide by 206265. There are 60 minutes in a degree of angle and 60 seconds in a minute.

**Area of Circle Given Radius**

Square of radius  $\times \pi$

**Area of Sector given Radius and Angle**

Turn angle into seconds, multiply by square of radius, divide by 412350.

**Volume of a Rectangular Paralleloiped**

This is a solid bounded by six rectangles. Multiply the area of the three sides that meet. If the piped is not rectangular (angles not right angles) multiply the area of one side by the perpendicular between it and its opposite side.

**Volume of a Pyramid (3 sides and a base)**

(area of base  $\times \perp$  from vertex to base)  $\div 3$

**Volume of a Prism (rectangular sides, parallel bases)**

area of base  $\times \perp$  distance between bases

**Surface Area of Sphere**

square of radius  $\times 4\pi$

**Volume of Sphere**

$4/3 \times$  cube of radius  $\times \pi$

**Surface of Right Cone (line through apex  $\perp$  to base)**

$\frac{1}{2} \times$  circumference of base  $\times$  slant height, which is the line from apex to base down the side of the cone.

**Volume of Right Cone**

$\frac{1}{3} \times$  area of base  $\times$   $\perp$  height

**Surface of Right Cylinder**

circumference of base  $\times$  height

**Volume of Right Cylinder**

$\frac{1}{3} \times$  area of base  $\times$  height

Given volume, weight is found if the weight of one cubic unit (inch, foot, millimeter) of its material is known. This weight or **specific gravity** is based on the weight of distilled water. Specific gravity of gold is 19.362 or  $19.362 \times$  weight of equal volume of distilled water.

Required: weight of gold sphere, radius 4 inches.

Method:

$$\text{volume is } 4^3 \cdot 4/3 \cdot \pi = 268.0832 \text{ in}^3$$

$$\text{each in}^3 \text{ of water} = 252.458 \text{ grains}$$

$$\text{each in}^3 \text{ of gold} = 19.362 \times 252.458 = 4888.091 \text{ grains}$$

$$\therefore \text{ sphere weighs } 268.0832 \times 4888.091 \text{ grains} \cong 227\frac{1}{2} \text{ troy pounds}$$

Because a cubic foot of water weighs 991.1369691 avoirdupois ounces we can round this off to 1000. If a substance has a specific gravity of 4.1172 then a cubic foot of it weighs 4117 ounces very nearly minus three parts in a thousand or 4105 ounces very nearly.



## Algebra

By this point, you can see that all the algebra that you have done so far in this text is merely arithmetic. You can add, subtract, multiply, and divide the simple algebraic expression we call polynomials. Just as there was much more to arithmetic with numbers than these four operations, there is much more to algebra beyond what you have done so far.

Do not short yourself on having dominion over the arithmetic of algebra. You will need every bit of it. If you think of everything that division led to in numbers, you will have a sense of how necessary division of polynomials is. There are software packages that will give you the GCF of several algebraic functions or do all the polynomial division necessary to produce a Reduced Groebner Basis. But you aren't likely to make that investment, are you? You will have to rely upon your own mind for everything.

In algebra, we have **algebraic** functions, which are these polynomials we've been dealing with. Then we have **transcendental** functions, which are basically infinite polynomials or **sums of infinite series**. And you will need to adapt your ability to multiply and divide the first in order to multiply and divide the second. The operations remain the same while the technique becomes more complicated. In mathematics, much of what is more complicated is actually still simple but requires greater patience and diligence to avoid introducing errors. So before we go on, make sure you are confident and comfortable in your skill of algebraic arithmetic.

I want to remind you that you are responsible for the development of your own mind. If you have not been working out examples on your own, you are failing in your effort to develop that mind. This text is a condensation of De Morgan's *Elements* series which includes only what is essential to the subject matter he chose so well. I have included even fewer exercises than he did. If you need more exercises to establish your dominion over these ideas, go get some. In these times, all of De Morgan's books are freely available in PDF format on archive.org. Of similar high quality are the works of Elias Loomis and Isaac Todhunter.

Todhunter's books, which either have answers in the back or separate answer key texts, are especially helpful. He was writing for the self-learner. So he included many exercises. And all of his exercises have intelligent answers. If you don't really need things spelled out, he indicates only the method. Often, he begins by saying you can do this in the normal way, which he may or may not spell out, and then gives another approach that is slightly more advanced. Often he answers begin in the middle and then he gives what you need to go on. Todhunter handles exercises better than anyone else.

In an essay which he wrote about self-study, he recommends that you not pick and choose among exercises. Basically, you're not qualified to pick them wisely. He suggests you do the first third of a set of exercises or every third exercise. In his works and in most other texts, the problems get harder as you go along in each set. It is worth your time to try to solve them until you can no longer understand the answers. It is absolutely worth your time to study every solution whether you solved the problem or not. The best authors use the solutions to teach more about the subject matter.

## The Form of Number

Every algebraic expression, if you will assign values to the letters, reduces to a number. In the rare cases where it doesn't, it reduces to something which has a form analogous to some expression of number. As we move from algebraic expression to specific number, the operations are repeatedly giving this same number different forms. At each step, from beginning to end, each of these forms can often be expressed in different ways, in different mathematical contexts. We might express this entire idea in a tree diagram where all of these forms lead to the one number. Therefore, whatever is true of each form in each context is true of everything in the tree, including the result.

The simpler the idea, the smaller the tree. If you have  $a + b = c$ , this is true for numbers where choosing any  $a$  and  $b$  determines a specific  $c$ . But it is also true of lines in pure geometry or in analytic geometry. And if those contexts buy us anything in our work with  $a + b = c$ , they are absolutely usable and true when translated into the original context. Let's take a more complex example:  $x^n + y^n = z^n$ . Here, the original question was "Can this be true when  $n > 2$ ?" No matter what else is true here, the sum of  $x$  and  $y$  stand in some relation to  $z$ . And if  $x + y > z$ , this is true about magnitudes of lines in pure geometry where the lines can be the sides of any triangle. If  $x + y \leq z$ , no triangle is possible. But if  $x + y > z$ , everything true about triangles is true about the original equation. And anything we can leverage from pure geometry or analytic geometry to solve our original equation is perfectly legitimate and will lead to true results.

What I am calling **number** is simply number itself, some value in **N**, **R**, etc. What I am calling the **form of number** is the tree that springs from something that implies number. The form of number is all of the consequences of that implication. We can think of our "something" as a seed. The seed implies perhaps a class of numbers. Assigning values to the seed produces specific number. The tree is everything that would equivalently imply what is implied at each step from statement of seed to resolution of seed into specific result. And this is all meant to be taken in a general sense. The result of an algebraic equation could be a simpler equation like an algebraic fraction in lowest terms. There is a tree that runs from seed to number whether we even think about assigning values and getting some number in return.

Every mathematician is aware of this idea to some extent. But I have never encountered this as presented here. The entire tree must exist for every seed -- but only as an ideal. What this ideal gives us is an awareness of the possibility and potential of related ideas. And it encourages us to develop that awareness. It also prevents us from letting our likes and dislikes of different mathematics influence our studies. We become more broadly interested in mathematical ideas as we follow our interests because we recognize those interests in different forms in different mathematics. So the form of number makes us less dogmatic. And it tends to unify things in unexpected ways.

This first part of our algebra section is, in De Morgan, a kind of introduction to algebra beyond its arithmetic. (He covered all the arithmetic of algebra in his Algebra's introduction.) I'm going to present his ideas as an introduction to algebra as form of number. Some things from earlier in this text will be repeated. But this time I hope you will see them in a new way, as important and recurring forms. Once aware of them in this way, you will more readily notice when they arise in other contexts.

In  $(a+x)^{7/3}(a+x)^{2/3}$ , you should see not only  $(a+x)^3$  but, by the end of the book,  $a^3 + 3a^2x + 3ax^2 + x^3$ . And  $1/1-x$  will immediately call to mind  $1+x+x^2+\dots$  and vice versa. Then in our work, we use whichever form is most useful to our task, sometimes moving freely back and forth between them. These forms are of the same level of generality. The form  $(1+x)^{2/3}$  is more specific than  $(1+x)^{m/n}$ . One should be able to move freely in this direction as well. It is easier to reason in general terms after mastering smaller and more specific instances. So the power of mathematics is not only the usages of general forms but the freedom to move among a multiplicity of relevant forms, both general and specific. Forms suggest not only their use but their own permutation:

$$\begin{aligned} \forall n \in \mathbf{N}, n \cdot n - 1 &= (n+1)(n-1) \\ (6 \cdot 6) - 1 &= 35 = (6+1)(6-1) = 7 \cdot 5 \\ (7 \cdot 7) - 1 &= 48 = (7+1)(7-1) = 8 \cdot 6 \\ \therefore n^2 - 1 &= (n+1)(n-1) \\ \therefore (n^2 - 1)/(n-1) &= n+1 \\ (n^2 - 1)/(n+1) &= n-1 \\ (n-1)/(n^2 - 1) &= 1/(n+1) \\ (n+1)/(n^2 - 1) &= 1/(n-1) \end{aligned}$$

Some forms should become so familiar that you simply see their equivalent expressions. Below,  $a+b$  and  $a-b$  are the sum and difference of any two numbers or magnitudes such as lines, areas, volumes. If we keep  $a > b$ , the sum of the sum and the difference is twice the greater number or magnitude, as in the next formula. All of these can be interpreted geometrically as well as numerically.

$$\begin{aligned} (a+b) + (a-b) &= 2a \\ (a+b) - (a-b) &= 2b \\ (a+b)^2 &= a^2 + 2ab + b^2 \\ (a-b)^2 &= a^2 - 2ab + b^2 \\ (a+b)(a-b) &= a^2 - b^2 \\ (a+b)^3 &= a^3 + 3a^2b + 3ab^2 + b^3 \\ (a-b)^3 &= a^3 - 3a^2b + 3ab^2 - b^3 \end{aligned}$$

Forms become familiar only through our working them out until they **are** familiar. Mathematics is stultified by rote memory. Observe and remember details, like alternation of sign, and concentrate on the principles involved.

$$(a+b)(a-b) = a^2 - ab + ab - b^2 = a^2 - b^2$$

We can take a more specific expression and then move among general forms:

$$x^2 + 5x + 6 = x^2 + (a+b)x + ab \text{ from } (x+a)(x+b) \Rightarrow (x+2)(x+3)$$

Here, the form becomes more complicated:

$$(ax+b)(cx+d) = acx^2 + (ad+bc)x + bd$$

Patterns arise from the form of number:

$$\begin{aligned}x^2 - a^2 &= (x - a)(x + a) \\x^3 - a^3 &= (x - a)(x^2 + ax + a^2) \\x^3 + a^3 &= (x + a)(x^2 - ax + a^2) \\x^4 - a^4 &= (x - a)(x^3 + x^2a + xa^2 + a^3) \\&= (x + a)(x^3 - x^2a + xa^2 - a^3) \\&= (x - a)(x + a)(x^2 + a^2)\end{aligned}$$

Discern the pattern.  $x^5 + a^5 = (x + a)$  (what?) and  $x^5 - a^5 = (x - a)$  (what?).

Some people can memorise a lot of these patterns and common forms. Some can't. Everything I'm not currently using evaporates from my mind and I have to look the same thing up over and over. If you are at all like me, do yourself a favor and make a little notebook of common forms and patterns. It's easier to dig these out of one little notebook than going back through all your books and notes. Notebook or not, it's best to play with the algebra a bit until you **see** the pattern. Here's the rule for the above:

<u>expr</u>	<u>factor</u>	<u>if</u>
$x^n - a^n$	$x - a$	$n \in \mathbf{N}$
$x^n - a^n$	$x + a$	$n \in \mathbf{N}$ and even
$x^n + a^n$	$x + a$	$n \in \mathbf{N}$ and odd

We have also seen instances of imposing a change of form. Here is a simple example of using a known technique and then your knowledge of the above form takes you to the conclusion. The value of these appear when the forms are much larger and you are able to simplify them.

$$x^3 - 1 = x^3 - x^2 + x^2 - x + x - 1 = (x - 1)(x^2 + x + 1) \therefore (x^3 - 1)/(x - 1) = (x^2 + x + 1)$$

Even the simplest of forms are malleable:

$$x = x + a - a = x - a + a = (ax)/a = 1/(1/x) = (1 + x)/(1/x(1 + x)) = (1 + x)/(1/x + 1)$$

$$a + x = 2a + x - a = a(1 + x/a)$$

$$a^2 + 2ab - c = a^2 + 2ab + b^2 - (c + b^2) = (a + b)^2 - (c + b^2)$$

$$b^2 - 4ac = b^2(1 - 4ac/b^2) = abc(b/ac - 4/b)$$

$$m + n = mn(1/n + 1/m) = n(m/n + 1) = m(1 + n/m)$$

$$\begin{aligned}1/(\sqrt{x} + 1) &= (\sqrt{x} - 1)/(\sqrt{x} + 1)(\sqrt{x} - 1) = (\sqrt{x} - 1)/(x - 1) \\&\therefore 1/(\sqrt{3} + 1) = \frac{1}{2}(\sqrt{3} - 1)\end{aligned}$$

And if you go back to any of our earlier examples of form, like the forms of fractions, all of these forms are valid if you replace a, b, c, ... with any algebraic expression, no matter how complex.

An important general form in algebra is any expression set equal to zero. This was first done by Harriot in the 17thC and made modern algebra possible. We have seen numeric roots: square roots, cube roots. In algebra, **roots** are also those values of the variable, say x, where the expression evaluates to 0.

In  $x^2 + (-a + b)x - ab$ , the roots are  $a$  and  $-b$ :

$$\begin{aligned}x = a &\Rightarrow a^2 + (-a + b)a - ab = a^2 - a^2 + ab - ab = 0 \\x = -b &\Rightarrow b^2 + (-a + b)(-b) - ab = b^2 + ab - b^2 - ab = 0\end{aligned}$$

In the simplest sense, we know that  $1 \cdot 1 = -1 \cdot -1 = 1$  so  $a \cdot a = -a \cdot -a = a^2$ . So we set equations equal to zero to find roots in both senses. If  $x$  is a square root of 1 then  $x^2 = 1$  or  $x^2 - 1 = 0$ . Handling  $a$  in the same way we have:

$$\begin{aligned}x^2 - 1 &= 0 & x^2 - a^2 &= 0 \\(x + 1)(x - 1) &= 0 & (x + a)(x - a) &= 0\end{aligned}$$

You can see that either equation as product equals zero if one of the factors equals zero. If we set any of the four factors equal to zero, say  $x + a = 0$ , we solve it for its root,  $-a$ . So the roots of  $x^2 - 1 = 0$  are 1, -1 and the roots of  $x^2 - a^2 = 0$  are  $a$ ,  $-a$  and the roots of  $x^2 - 49 = 0$  are then 7, -7. Properly speaking,  $x^2 - a^2$  is an expression and has no roots.  $x^2 - a^2 = (a + 256)$  is a conditional equation which may or may not have a solution.  $x^2 - a^2 = 0$  is an equation which allows us to solve for the roots of  $x^2 - a^2$ .

In the same way, consider  $x^3 - 1 = 0$ . From above we have:  $(x - 1)(x^2 + x + 1)$ . Later in this text we will easily solve this second factor. Then our three factors of  $x^3 - 1$  will each have a root. These roots are 1,  $(-1 + \sqrt{-3})/2$ ,  $(-1 - \sqrt{-3})/2$ . Clearly, 1 is a root:  $1^3 - 1 = 0$ . Without trying to define  $\sqrt{-3}$  yet, we can show it is algebraically consistent and you can use the third root as an exercise.

$$\begin{aligned}x &= (-1 + \sqrt{-3})/2 \\ \therefore x^2 &= ((-1)^2 + 2(-1)(\sqrt{-3}) + (\sqrt{-3})^2) / 4 \\ &= (1 - 2\sqrt{-3} + (-3)) / 4 \\ &= (-2 - 2\sqrt{-3}) / 4 \\ &= (-1 - \sqrt{-3}) / 2 \\ \therefore x^2 + x + 1 &= (-1 - \sqrt{-3}) / 2 + (-1 + \sqrt{-3}) / 2 + 1 \\ &= (-1 - 1) / 2 + 1 = -1 + 1 = 0\end{aligned}$$

Numbers in the form  $(a + b\sqrt{c})/d$  used to be called **surds**. Now they are called **radical expressions** or simply **radicals**. Later we will talk about the sense and meaning of  $\sqrt{a}$  and how this leads to complex numbers. All of these things are, at bottom, quite simple and obey all the laws of arithmetic. Let's take an  $x + \sqrt{y}$  and square it:

$$(2 + \sqrt{7})^2 = 2^2 + 2 \cdot 2\sqrt{7} + (\sqrt{7})^2 = 4 + 4\sqrt{7} + 7 = 11 + 4\sqrt{7}$$

Nothing new there. Simply the form  $(a + b)^2$  and correctly handling the radical sign. Now let's take the square root of this result which we know has the form of  $x + \sqrt{y}$ . Pay attention to how we use the form of number here.

$$\begin{aligned}(11 + 4\sqrt{7})^{1/2} &= x + \sqrt{y} \quad [1] \quad (\text{square both sides}) \\ 11 + 4\sqrt{7} &= x^2 + 2x\sqrt{y} + y = (x^2 + y) + 2x\sqrt{y} \\ \therefore x^2 + y &= 11 \quad [2] \quad \text{and } 2x\sqrt{y} = 4\sqrt{7} \quad [3] \quad (\text{we get both of these from [1]}) \\ \therefore x^2 - 2x\sqrt{y} + y &= 11 - 4\sqrt{7} \quad ([2] - [3]) \quad \therefore (x - \sqrt{y})^2 = 11 - 4\sqrt{7} \quad \therefore x - \sqrt{y} = (11 - 4\sqrt{7})^{1/2} \\ \text{But } x + \sqrt{y} &= (11 + 4\sqrt{7})^{1/2} \quad ([1]) \quad (\text{multiply these last two as } (a-b)(a+b)) \\ \therefore x^2 - y &= (11 - 4\sqrt{7})^{1/2} (11 + 4\sqrt{7})^{1/2} = ((11 - 4\sqrt{7})(11 + 4\sqrt{7}))^{1/2} = (121 - 112)^{1/2} = 3 \\ \text{But } x^2 + y &= 11 \quad ([2]) \quad \therefore x^2 - y + x^2 + y = 11 + 3 = 14 \quad \therefore x^2 = 7 \quad \therefore x = \sqrt{7} \\ \text{and } x^2 - y - (x^2 + y) &= 2y = 11 - 3 = 8 \quad \therefore y = 4 \quad \therefore \sqrt{y} = 2 \\ \therefore x + \sqrt{y} &= \sqrt{7} + 2 = 2 + \sqrt{7} \quad (\text{as we began})\end{aligned}$$

If the surd had been in the form  $x - \sqrt{y}$ , another method using another form would have been used. As with fractions, computations on calculators are more accurate if you keep the radicals until the final calculation. Otherwise, you truncate their value and exaggerate that truncation with every multiplication or division that follows. Or you can toss the beggars out. The radicals, I mean. In what follows, consider that when solving for roots, you can multiply the LHS by any constant and not change the roots or  $(x - a)(x - b)$  and  $(4 + \sqrt{7})(x - a)(x - b)$  give the same roots: a, b.

So to get rid of a radical, say  $\sqrt{3}$ , multiply the expression by  $\sqrt{3}$  where  $\sqrt{3} \cdot \sqrt{3} = 3$ .

To get rid of two,  $\sqrt{3} + \sqrt{2}$ , from  $a^2 - b^2 = (a + b)(a - b)$ , multiply by  $\sqrt{3} - \sqrt{2}$  giving you  $(\sqrt{3} + \sqrt{2})(\sqrt{3} - \sqrt{2}) = 3 - 2 = 1$ .

To get rid of three,  $\sqrt{3} + \sqrt{5} - \sqrt{7}$ , this is  $\sqrt{a} + \sqrt{b} + \sqrt{c}$  in general form. Then

$$(\sqrt{a} + \sqrt{b} + \sqrt{c})(\sqrt{a} + \sqrt{b} - \sqrt{c}) = (\sqrt{a} + \sqrt{b})^2 - (\sqrt{c})^2$$

$$= a + 2b\sqrt{a} + b - c = a + b - c + 2b\sqrt{a}$$

Then  $(a + b - c + 2b\sqrt{a})(a + b - c - 2b\sqrt{a}) = (a + b + c)^2 - 4ab$  and the radicals are gone.

The strategies of removing radicals to obtain exact solutions vary. But all rely upon your knowledge of the form of number.

## First Degree Equations

Instead of "equation," we will use the abbreviation "eqn" and instead of "first degree" we'll use "1°." So "n° eqn" is an "equation of degree n." "Variables" will become "vars" "Solution" becomes "soln." More laziness to come; let's move on.

Eqns are general statements. **Identical** eqns are completely general, true for any values assigned to the vars. An example would be  $(a^2 - 1)/(a + 1) = (a - 1)$ . Eqns of **condition** are general states of a particular case. In every state of affairs where there are eight things, one general state is  $a + 1 = 8$ . The var a here can only be 7. One assumes that the conditions of the eqn exist and are true. Then one determines which values maintain the truth of the proposition. But a state of affairs in mathematics need not be a material state in the world of experience. A particular case of the relation of integers is: "To what number can 56 be added so that the result is 200 reduced by twice the required number?"

$$\begin{array}{ll} x + 56 = 200 - 2x & (+ 2x \text{ both sides}) \\ 3x + 56 = 200 & (- 56 \text{ both sides}) \\ 3x = 144 & (\div 3 \text{ both sides}) \\ x = 48 & (\text{we will no longer write "both sides"}) \end{array}$$

But if we put this in completely general terms: "To what number can any chosen a be added so that the result is any chosen b reduced by c times the number?"

$$\begin{array}{l} x + a = b - cx \\ (c + 1)x + a = b \\ (c + 1)x = b - a \\ x = (b - a)/(c + 1) \end{array}$$

1° eqns are simple equations with only the first power of x and are geometrically expressed as a line. We apply Euclid's axioms of equality (as above) to isolate x on LHS, putting the solution on the RHS. The method of solution is:

- 1) Clear fractions. Multiply both sides by LCM of denoms.
- 2) Move terms with x to the LHS by subtraction applied to both sides.
- 3) Isolate x. Factor x out of LHS terms and divide both sides by x's coefficient.

$$\begin{array}{l} cehx + abehx = acdh - ace(f - gx) \\ (ceh + abeh)x = acdh - acef + acegx \\ (ceh + abeh - aceg)x = ac(dh - ef) \\ x = (ac(dh - ef))/(ceh + abeh - aceg) \end{array}$$

When we talk about the degree of an equation of one variable, we are asking what is the highest power of that variable in the equation once all the terms of that variable have been moved to the LHS:

$$\begin{array}{ll} 3x + 6 = 0 & 1^\circ \\ x^2 + 3x + 1 = 0 & 2^\circ \end{array}$$

- 1)  $2x - 1 = 5x - 19$  ( two 1° eqns in an equality )  
 $3x - 18 = 0$  ( same thing in standard form )  
 $3x = 18 \therefore x = 6$  ( solution )

This idea of degree is also sometimes used in this way. The term or expression  $3a^2x^2y$  is  $2^\circ$  in  $a$ ,  $2^\circ$  in  $x$ ,  $1^\circ$  in  $y$ ,  $3^\circ$  in  $xy$ , and  $5^\circ$  in  $axy$ . But most of the time this term would be viewed as a term with a constant of  $3a^2$  in vars  $x$ ,  $y$ , or  $xy$  as shown. Almost always, letters in algebra are used in this fashion:

$a, b, c, \dots$	vars if alone, constants if $x$ or $y$ in use
$x, y, z$	vars only
$p, q, r, \dots$	usually constants
$m, n$	usually integer constants

Earlier, the word "dimension" was used for "degree" and you will still find this where geometric interpretation is obvious. They mean the same thing. Solving  $1^\circ$  eqns relies almost entirely on these Axioms of Equality below. Keep in mind here that  $a$  and  $b$  are the existing LHS and RHS of the equality. So if  $a = b$  then

- 1)  $a + c = b + c$
- 2)  $a - c = b - c$
- 3)  $ac = bc$
- 4)  $a/c = b/c$

To solve that first eqn where  $x = 48$ , we used #1, #2, and then #4. Here we use #3, #1, and then #4. I'm only pointing this out so that no one will think that there is more to it than this. We apply the axioms, using simple arithmetic to isolate  $x$  on the LHS which puts the soln on the RHS to be simplified if necessary. Nothing else is going on here.

$$\begin{array}{ll}
 2) & x/2 + x/3 = 1 - x/4 & (\text{lcm}(2,3,4) = 12 \therefore \times 12) \\
 & 6x + 4x = 12 - 3x & (+ 3x) \\
 & 13x = 12 & (\div 13) \\
 & x = 12/13 &
 \end{array}$$

$$\begin{array}{ll}
 3) & ab + a - b = 1 & (\text{solve for } a) \\
 & ab + a = b + 1 \\
 & a(b + 1) = b + 1 \\
 & a = 1 & (\text{and if you solve for } b?)
 \end{array}$$

$$\begin{array}{ll}
 4) & xy = x + y + 1 & (\text{solve for } x) \\
 & xy - x = y + 1 \\
 & x(y - 1) = y + 1 \\
 & x = (y + 1)/(y - 1)
 \end{array}$$

- 5) 2 men can mow a given field alone in 4 and 7 days. Together in 1 day. Day 2, 3d man joins them who can mow it alone in 10 days. But 3d man leaves as soon as  $4/5$  of the field is done. How many days is this?

$$\begin{array}{l}
 x = \text{days} \\
 \text{each day, first 2 men mow } 1/4 \text{ and } 1/7 \text{ of the field} \\
 \text{from day 2, 3d man mows } 1/10 \\
 \therefore x/4 + x/7 + (x - 1)/10 = 4/5
 \end{array}$$

You can do the math if you are curious about the soln. Our  $1^\circ$  eqn here is a **linear model** because a  $1^\circ$  eqn can be expressed geometrically as a line. But what is on the top of the fractions? And what do the denoms mean? Why  $(x - 1)$ ? As soon as our eqn describes a state of affairs in the world, every part of it must have a meaning. Error arises from meaninglessness or carelessness and generally both.



You will find that the most important question in solving states of affairs is, "How do we meaningfully say that?"

- 6) Consider  $ax + b = cx + d$  which has  $x = (d - b)/(a - c)$  as soln.  
 If  $a = c$ , we have  $x = (d - b)/0$   
 If also  $b = d$ , we have  $ax + b = ax + b$  which says nothing.  
 It is a **tautology** or "is true in all cases." Let  $a = c$ ,  $b \neq d$ :  
 $4000x + 5000(x + 10) = 9000(x + 12)$  (simplify to  $ax + b = cx + d$ )  
 $9x + 50 = 9x + 108 \therefore x = 58/0$   
 If we change 9000 to 8999 in the original eqn, we get  $x = 57,988$ .  
 If we use 8999.99, then  $x = 5,799,988$ . You can see where this is going.  
 Go back to  $x = (d - b)/(a - c)$ .  
 Let  $a - c = 1/q =$  some very small difference  $\therefore x = (d - b)/(1/q) = q(d - b)$   
 The modern way to express what happens here is:  $1/q \rightarrow 0 \quad q(d - b) \rightarrow \infty$  or  
 "as  $1/q$  goes to zero,  $q(d - b)$  goes to infinity." We also say here that  $x$  is **asymptotic**. This **means** that no finite  $x$ , no matter how large, satisfies the eqn.  
 Infinity is not a number, as it is infinitely larger than any finite number, no matter how large. As a noun, infinity leads to paradox and contradiction.  
 But as an adverb, it is perfectly reasonable. We would get a perfectly reasonable soln here, if we calibrated our approximation of 9000 (i.e. 8999, 8999.99) to give a soln with an acceptable margin of error.

- 7)  $ax + b = cx + d$   
 If  $a = c$  and  $d = b$  then  $x = 0/0$ . Now what?  
 This arises when  $a, b, c, d$  are themselves complex expressions and you spend hours simplifying it towards a soln, only to end up with  $0/0$ .

Consider: Is there a number such that  $a$  times one less than the number added to  $b$  times two more than the number is exactly  $c$  times the number? This could arise in any context where  $a, b, c$  are specific numbers. The general soln:

$$\begin{aligned} x &= \text{the number} \\ a(x - 1) + b(x + 2) &= cx \quad [1] \\ ax - a + bx + 2b &= cx \\ ax + bx - cx &= a - 2b \\ x(a + b - c) &= a - 2b \\ x &= (a - 2b)/(a + b - c) \end{aligned}$$

If  $a = 8, b = 4, c = 12, (8 - 2 \cdot 4)/(8 + 4 - 12) = 0/0$ . Go back to [1].

$$\begin{aligned} 8(x - 1) + 4(x + 2) &= 12x \\ 8x - 8 + 4x + 8 &= 12x \\ 12x &= 12x \end{aligned}$$

With these specific values assigned, the eqn becomes **indeterminate**. Or, for any  $x$  whatsoever,  $12x$  will equal  $12x$ . If the question here about  $x$  had been meaningful, you would then investigate the reasons or states of affairs which led to the indeterminacy. Such reasons could come from actual relations in the world, from the choice of mathematical model, from internal mathematical necessity, from your own mental defect, etc. But there will be a reason.

General condition versus particular case: The general conditions determine the form. Particular case determines the sense of the model where the values are concrete expressions.

When we use mathematics to solve for something in the world of experience, we are creating a representation which expresses those elements of a state of affairs which are relevant to the solution.

- 8) Two men leave the same place. The first leaves at ten o'clock, travels at two mph. The second leaves at two o'clock, travels at three mph. When does the second pass the first?

This when is  $x$  hours for the 2d,  $(x+4)$  hours for the 1st or

$$x = x + 4$$

But we also need the rates of travel in this representation or

$$\begin{array}{ll} 3x = 2(x + 4) & \text{( simplify )} \\ 3x = 2x + 8 & \text{( -2x )} \\ x = 8 & \end{array}$$

$\therefore$  2d passes 1st at  $2 + 8 = 10$  o'clock. Let the 2, 3, and 4 above be a particular case, then the general case is:

$$\begin{array}{ll} bx = a(x + c) & [1] \\ (b - a)x = ac & \\ x = ac/(b-a) & [2] \end{array}$$

where [1] is the form of the **general condition** (this is an eqn of condition) or **representation** and [2] is the general solution for this state of affairs.

This expression of "state of affairs" is from Ludwig Wittgenstein's *Tractatus Logico-Philosophicus*. It is a short and very readable work of critical philosophy and has a direct bearing on modern thought. (Clearly, most people are unaware of where their thoughts come from.) Although superseded in parts by his later work, it would be worth your while to study it. I find it enjoyable to read. As for word problems:

*The reduction into equations of such problems as are usually given in the treatises on algebra rarely occurs in mathematics. ... [N]o student need give a great deal of time to it. Above all, let no one suppose, because he finds himself unable to reduce to equations the conundrums with which such books are usually filled, that, therefore, he is not made for the study of mathematics, and should give it up.*

That was De Morgan. His student, Isaac Todhunter, F.R.S., wrote a long essay condemning just such conundrums as appeared in the Cambridge Tripos. De Morgan continues:

*But he may never, perhaps, make any considerable step for himself.*

By which he means "make any considerable contribution to mathematics." I take this to mean that making a real contribution requires the ability to grasp both the full sense of mathematics itself and to relate it to the reality of the world by creating a meaningful representation. It was Richard Courant who I earlier quoted and whose quote ended with:

*Only under the discipline of responsibility to the organic whole, only as guided by intrinsic necessity, can the free mind achieve results of scientific value.*

In the 20th century, mathematics focused not on the organic whole but upon its own tautologies. This concentration on abstraction has led to a devaluation of mathematics in

those cultures where this happened. Tenure-track positions have decreased. Temporary positions in universities have soared. And these positions pay no more than instructor positions held by masters instead of doctors a generation ago. Abstraction must always reflect back down on specific, not necessarily applied, problems.

- 9) A agrees to take B's property and pay his debts. A finds B's value to be the same as his own, except B has a partner and B and his partner have made a similar agreement with C who is 100 pounds in debt. In the end, A's value is 75 pounds short of being twice as much as he began with.  
Required: A's initial value.

$$\begin{aligned} \text{A's initial value} &= \text{B \& Co.'s} = x \\ \therefore \text{B} &= (x - 100)/2 && \text{[ 100 loss to C then B \& Co. split evenly ]} \\ \text{A's 75 short of double value} &= 2x - 75 \\ \\ x + (x - 100)/2 &= 2x - 75 && (\times 2) \\ 2x + x - 100 &= 4x - 150 \\ -4x + 3x &= -150 + 100 \\ -x &= -50 && (\times -1) \\ x = 50 &= \text{A's initial value. } \therefore \text{for B, } (50 - 100)/2 = -25 \end{aligned}$$

When dealing with abstract numbers, -25 is simply directional. It would be easy here to just say B was 25 pounds in debt and go on. But in expressing a picture of the world by mathematical representation, you must know what you have said in your representation and what assumptions you have expressed.

Here, we assumed  $x > 100$  which was false and we assumed A gained. The more accurate representation changes

$$x + (x - 100)/2 \text{ to } x - (100 - x)/2$$

Again  $x$  would be 50. The **point** is that if you cannot express a simple representation accurately, how will you judge what you are **actually saying** with second order tensors or even simple Calculus?

Further, the accurate representation cannot always be determined in advance. B was in debt -- who knew? Here  $-x$  **shows** the false assumption. False assumptions are not restricted to applied mathematics. They appear everywhere in your thinking. And you can only detect them if you are aware of the **meaning** in your work.

- 10) In 1830, A is 50 and B is 35. When will A be twice as old as B?

$$\begin{aligned} \text{This when will be } 1830 + x. \text{ A becomes } 50+x. \text{ B, } 35+x \text{ and } A = 2B \\ \therefore 50 + x &= 2(35 + x) \\ 50 + x &= 70 + 2x && \text{( Assumed } x \text{ in future )} \\ -2x + x &= 70 - 50 && \text{( But } x \text{ in past )} \\ x &= -20 \end{aligned}$$

$$\text{Correct statement: } 1830-x, 50-x, 35-x \Rightarrow x = 20 \quad A = 30 \quad B = 15$$

These examples are trivial. But we must speak a language simply before we can introduce complexity.  $50+x$  has the **wrong meaning**.  $50-x$  expresses the **truth**.

- 11) A and B have accounts in common. They will be even if you give A half as much as will make him worth 500 and give B 100.  
Required: current state of accounts.

Be aware of assumptions as you make them. You have to assume that either A or B has more right now. Assume A. Then he should get  $x$  from B and we know  $500-x$  makes the deal worth 500 to him as this next form is always true:

$$x + (500 - x) = 500$$

So we give B 100 and give A half of this  $(500 - x)$  so he has  $x + (500 - x)/2$  and say this as

$$x + (500 - x)/2 = 100 - x$$

But this makes  $x = -300$ . Our assumption was wrong. A should have settled with B giving him the  $x$ . The correct LHS is  $((500+x)/2) - x$  and RHS is  $100+x$ .

Think about this state of affairs until you can clearly say what these correct versions **mean**. The resistance of the finite mind to establish and maintain meaning amounts to a denial of the truth. What drives the establishment and perfection of meaning is a love of truth. Honest self-evaluation will reveal that this is so.

- 12) A traveler is on a road with five signs pointing north and south alternately and will use each sign once. He walks 16 miles to the first sign and goes in the indicated direction, in which he may or may not have been going. He goes north or south at each sign he comes to, each sign being twice as far as the previous. At the fifth sign he is 86 miles north of his origin.  
Required: arrangement and direction of signs.

If we break this down, we can do this. We must make assumptions and keep track of them. We must pay attention to falsities and contradictions as they arise and then go back and adjust our assumptions accordingly. Without our attention to what is meaningful and persistent careful thought, solution is impossible. You will need a diagram.

16 m to first post. Forward or back? Assume forward.

$x$  miles to 2d post at  $16+x$  miles. Must turn back. So two cases:

1) if  $2x < 16+x$ , 3d post is  $16 + x - 2x$  from origin; or

2) if  $2x > 16+x$ , 3d post is  $2x - (16 + x)$  from origin. Assume case 1.

So he goes north from 3d to 4th post.

$\therefore$  4th post  $16 + x - 2x + 4x$  north of origin

$\therefore$  5th post  $16 + x - 2x + 4x - 8x$  north of origin

$\therefore 16 + x - 2x + 4x - 8x = 86$

Work this out and you will see it gives a negative answer. Which assumptions were wrong?

Assume he goes south at the 1st post.

$\therefore 2d$  is  $16-x$  north of origin or  $x-16$  south of it

This depends on whether  $x$  is greater or less than 16 (diagram?)

We then get  $16 - x + 2x - 4x + 8x = 86$  or  $x = 14$

This gives us posts as follows:

Posts	(4)N	(2)N	(1)S	(3)S	(5)
Miles	26	0	2	16	30
					86

0 is origin. We can see that 1<sup>o</sup> eqns are corrected by changing the signs of the terms

containing  $x$ . This alters the sign in the result. And it shows the change of **meaning** in terms of  $x$ . We must master meaningful expression which relies only upon correct framing of the simple  $ax + b = c$  representation and a choice of sign before we can master meaning which depends upon more choices than this.

- 13) Divide 13 into two parts: 3·1st part  $> \frac{1}{2}$ ·2d part by as much as the 1st part  $> 4$ .  
Recall than two parts of  $n$  is always  $x + (n - x)$  so

$$3x - (13 - x)/3 = x - 4$$

Can you see that all of the given relations are present in this equation?

This gives 1st part = 1, 2d part = 12. But then 3·1st does not exceed half the 2d. Where is the false assumption? Change the signs:

$$(13-x)/2 - 3x = 4 - x$$

This shows that the  $>$  should be  $<$ . And this assumption was given us.  
We didn't make it. In representations, some assumptions come from a greater depth than we expect.

You can see from our sign-posts how necessary meaning is to our solutions. And you can see that a solution must track assumptions and their consequences. The next six examples show the permutations of meaning in a simple problem. Two couriers, A and B, travel between C and D. A goes  $n$  mph and B goes  $m$  mph. A and B are at this moment  $a$  miles apart. When do they meet?

1)

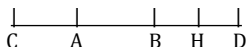

Suppose A,B go same direction, C to D and  $m > n$ .  $AB = a$ .

Then they meet at H between B and D. Let  $AH = x$ .

Then A goes  $x$  while B goes  $x-a$ .

A does this in  $x/m$  hours.

( miles/(miles/hours) )

B then requires  $(x-a)/n$  hours.

$$x/m = (x-a)/n$$

$$\therefore x = ma/(m-n) = AH$$

$$x-a = na/(m-n) = BH$$

They meet after  $x/a$  or  $a/(m+n)$  hours.

2)



They travel in same direction but  $n > m$ .

Then they must have already met.

Again  $AH = x$  but  $BH = x + a$ . Then

$$x/m = (x+a)/n$$

$$AH = x = ma/(n-m)$$

$$BH = na/(n-m)$$

$$\text{Time} = a/(n-m)$$

- 3) Moving D to C and  $m > n$ .  
This is same soln as #2 but with diagram reversed.  
( Verify this to assure yourself of the meaning expressed. )
- 4) Moving D to C and  $n > m$ .  
This is same soln as #1 but with diagram reversed.  
( Are these diagrams simply reversed or is there more to it? )



A towards D, B towards C, m and n as you please.  
So they meet between A and B.  
 $AH = x$   $BH = a - x$  Then

$$\begin{aligned}x/m &= (a-x)/n \\x &= ma/(m+n) \\a-x &= na/(m+n) \\Time &= a/(m+n)\end{aligned}$$

- 6) A towards C, B towards D, m and n as you please.  
So they already met between A and B.  
This is the reverse of #5 but with identical soln.

Circumstances of the case.	Direction of the point H.	Value of AH.	Value of BH.	Time of meeting
1. $\left\{ \begin{array}{l} \text{Both move from } C \text{ to } D, \\ \text{A moves faster than } B. \end{array} \right.$	Between B and D.	$\frac{ma}{m-n}$	$\frac{na}{m-n}$	$\frac{a}{m-n}$ after.
2. $\left\{ \begin{array}{l} \text{Both move from } C \text{ to } D, \\ \text{A moves slower than } B. \end{array} \right.$	Between A and C.	$\frac{ma}{n-m}$	$\frac{na}{n-m}$	$\frac{a}{n-m}$ before.
3. $\left\{ \begin{array}{l} \text{Both move from } D \text{ to } C, \\ \text{A moves slower than } B. \end{array} \right.$	Between A and C.	$\frac{ma}{n-m}$	$\frac{na}{n-m}$	$\frac{a}{n-m}$ after.
4. $\left\{ \begin{array}{l} \text{Both move from } D \text{ to } C, \\ \text{A moves faster than } B. \end{array} \right.$	Between B and D.	$\frac{ma}{m-n}$	$\frac{na}{m-n}$	$\frac{a}{m-n}$ before.
5. $\left\{ \begin{array}{l} \text{A moves towards } D \text{ and} \\ \text{B towards } C. \end{array} \right.$	Between A and B.	$\frac{ma}{m+n}$	$\frac{na}{m+n}$	$\frac{a}{m+n}$ after.
6. $\left\{ \begin{array}{l} \text{A moves towards } C \text{ and} \\ \text{B towards } D. \end{array} \right.$	Between A and B.	$\frac{ma}{m+n}$	$\frac{na}{m+n}$	$\frac{a}{m+n}$ before.

Here, the data, expressed as negation in the result, determines the placement of AH and BH and the placement of time in past or future. In cases #1 and #5 all is the same but the direction of B. This is seen in #1 as  $n > 0$  and in #5 as  $n < 0$ . This changes the placement of BH. Sym. in #6, the placement of AH is deducible from AH in #1. Every case may be deduced from #1 by attending to the **meaning** of negation **in this context**. Comparing the data in the table of each case to case #1 will show you what this means. If we take #1 as the general form, **all** of these consequences are latent.

*The principle is, that a negative solution indicates that the nature of the answer is the very reverse of that which it is supposed to be in the solution.*

Sym., if we expect a negative solution, a positive result shows us to be mistaken. If we have no expectations, we are asking questions without any meaning attached. These

would be **meaningless** questions. Then what does it mean, if in our work, we are unable to conceive of how to formulate a question of which we have expectations for the result? Let us look at other meanings:

For any fraction  $a/b$ , as  $b$  diminishes,  $a/b$  increases:

$$2/4 < 2/3 < 2/2 < 2/1 < \dots$$

General case, if  $b \rightarrow 0$  then  $a/b \rightarrow \infty$  or continual decrease of  $b$  means  $a/b$  passes through "all" values greater than its initial value. But consider our two couriers A,B, if  $m = n$ . Then  $AH = ma/(m-n) = ma/(m-m) = ma/0$ . In another more geometric context, we could say that A and B meet at infinity. But in this case  $m=n$  leads to  $x = x-a$ . If point A and B coincide, then  $a=0$  and  $x = x-a$  is **true**. But if A and B are separate,  $x = x-a$  shows our initial question to be absurd. A never meets B if  $m=n$ .

The symbol  $\infty$  is not a number. It is indicative of an adverb, that is, that we continue to add one number or term after another without cease. We cannot actually do this. But we can draw conclusions about an "infinite form" from a general form. An  $a/0 = \infty$  means that  $a/0$  increases without limit. Or  $x = x-a$  is the same as  $1 = 1 - a/x$  and this "approaches equality" as  $x$  increases without limit. But there can be no final value of  $x$  and, therefore, no final equality. If  $m=n$ , then as CA increases, AB becomes a smaller part of CB. But AB is constant.

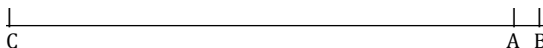

The truth in this picture is true of every picture using this form. Going back to the idea of  $A=B$  when  $m=n$ , then  $a=0$  and  $AH = ma/(m-n) = m0/(m-m) = 0/0$ . Here there is no unique AH because everywhere  $A=B=H$ . In both cases of  $a/0$  and  $0/0$ , these results expose errors of assumption in the context of the two couriers. In other contexts, other contradictions will be exposed. What then does it mean if these arise in a context for which no errors can be determined? It means the context is a tautology from which no meaning can arise.

There is a geometry to first degree equations. All first degree equations can be resolved to  $mx + c = 0$  which is where the line  $y = mx + c$  intersects the x-axis. Let me explain. Take a nice flat infinite Euclidean plane. Introduce two infinite lines at right angles. The horizontal one is the x-axis; the vertical, the y-axis. Arbitrarily choose a unit measure. Then the intersection of the axes is the **origin** with coordinates (0,0). If we use our unit measure and go one unit to the right from (0,0) we are at (1,0); if to the left (-1,0); if towards the top (0,1) and to the bottom (0,-1). We can then, conceptually, consider that, by using the axes as measure, any point in the plane can be labelled  $(x,y)$  for some  $x,y \in \mathbf{R}$ .

Going back to  $y = mx + c$ , let  $m$  and  $c$  be defined and we can set  $x=0$  to get the line's intersection with the y-axis at some (0,y) and set  $y=0$  for its x-axis intercept at some (x,0). Mark those points on the plane, connect the dots, extending the line "infinitely" in both directions and you have  $y = mx + c$  in a geometric context with its new form, which is equivalent to the algebraic form. Other forms are possible. Do a few of these and you will see that  $m$  measures the angle of the line with the x-axis. We call  $m$  the **slope** and it is actually the tangent of the angle of intersection. A line has everywhere the same slope. You can play with  $c$  and see that it is a vertical translation of a line. (You are working with diagrams here, right?)

A line in general form is  $ax + by + c$ , which we set to equal to 0 to solve. You can go back to any example in this chapter, interpret it geometrically, and see what "solution" means geometrically. If we solve the form for  $y$ , we get  $y = -a/b \cdot x + -c/b$  and we simplify this to our  $y = mx + c$  by considering  $m = -a/b$  and  $c$  to be a constant equal to  $-c/b$  where, here,  $c$  is

one and  $-c$  in the other are in no way related. They are names of different things. All of the points of a line come from the equation  $y = mx + c$ . With  $m$  and  $c$  defined, any  $x$  (on the  $x$ -axis)  $\in \mathbf{R}$  gives a  $y$  and we plot  $(x,y)$  on the plane. The  $y$ , in this sense, is Newton's way of calling  $mx+c$  a function of  $x$ . More commonly, we use Leibniz's notations and say  $f(x) = mx+c$ . The two are equivalent. Newton's is clearly inferior once we go beyond the second derivative in Calculus. So the  $y$  notation lingers only in the simple forms of low degree.

You will discover that you need one equation for every variable or **unknown** you are trying to solve. If I give you  $x + y = 8$  and  $x,y \in \mathbf{R}$  you can choose solutions using simple addition and subtraction until our sun goes out and you freeze in place. But with two **simultaneous eqns** we can have a soln that tells us where the lines intersect:

$$\begin{aligned} x + y &= 12 && [1] \\ 3x - 2y &= 31 && [2] \\ \text{From [1] } y &= 12 - x \text{ and substitute (sub) this into [2]} \\ 3x - 2(12 - x) &= 31 \\ 3x - 24 + 2x &= 31 \\ 5x &= 55 \\ x &= 11 \text{ and sub this into [1]} \\ 11 + y &= 12 \\ y &= 1 \\ \text{soln: } (11,1) &&& \text{ ( the point where the two lines intersect )} \end{aligned}$$

This is one way to do it. There is a better way that simplifies the work as the eqns grow in size. Before we look into that -- a reminder about proofs. Everything in this book can be and has been proven or "shown mathematically to be always tautologically true." Most texts prove most of what they present. This text does not. It concentrates on the doing of proven mathematics. We are dealing with the long-established, well-and-truly proven core of mathematics. Here, we only use proofs when they are the best explanation. Those who are more mathematically inclined may feel the need of more proofs. Go and find them. Proofs are very important. To really learn proofs, study Euclid.

Here's another way to solve these simultaneous eqns. We still use Euclid's axioms to arithmetically alter the lines. We can multiply or divide a line by any number without changing the soln. And we can add or subtract the lines from each other. This is matrix arithmetic. Here is the old method on the left, new one on the right:

$$\begin{array}{lll} x + y = 12 & (a) & 1 \ 1 \ 12 \\ 3x - 2y = 31 & (b) & 3 \ -2 \ 31 \\ \\ 3x + 3y = 36 & (\times 3) & 3 \ 3 \ 36 \\ 3x - 2y = 31 & & 3 \ -2 \ 31 \\ \\ 3x + 3y = 36 & & 3 \ 3 \ 36 \\ 5y = 5 & (a - b) & 0 \ 5 \ 5 \\ \\ 3x + 3y = 36 & & 3 \ 3 \ 36 \\ y = 1 & (\div 5) & 0 \ 1 \ 1 \\ \\ 3x & = 33 & (a - 3b) & 3 \ 0 \ 33 \\ y & = 1 & & 0 \ 1 \ 1 \\ \\ x & = 11 & (\div 3) & 1 \ 0 \ 11 \\ y & = 1 & & 0 \ 1 \ 1 \end{array}$$



Again, the soln is (11,1). You can see that the method simply uses the above rules of arithmetic to produce a result where  $1 \times$  each var is on a line by itself with its soln. The blocks of number on the right are usually enclosed by large brackets but my software won't do that just as it won't do the enclosing vertical lines of the next bit. We can use the coeffs of the vars in each eqn to determine if there is a solution before we even begin the above method. If lines are parallel, they don't intersect and parallel lines are shown geometrically by their identical angular intersection with a third line. Parallel lines, in analytical geometry, have coeffs which are multiples of e.o. Consider the last two lines:

$$\begin{array}{r} 1 \quad 1 \quad x_1 \quad y_1 \\ 3 \quad -2 \quad x_2 \quad y_2 \end{array}$$
 We are finding the **determinant** (det) here. For a  $2 \times 2$  matrix the  $\det = x_1y_2 - x_2y_1$  or  $-2 - 3 = -5$ . If  $\det \neq 0$ , there is a soln.

We can prove the general case that parallel lines, which have no soln, must have  $\det = 0$ . In Euclid's terms, two lines cannot enclose a space; they must have 0, 1, or all points in common. If lines are parallel, their coeffs are multiples of each other, so we have:

$$\begin{array}{l} ax + by = c \\ nax + nby = nc \quad ( \text{or} ) \\ \begin{array}{cc} a & b \\ na & nb \end{array} \quad ( \text{in matrix form} ) \\ \therefore \det = a \cdot nb - na \cdot b = nab - nab = 0 \end{array}$$

Also, we can say that parallel lines have same slope, different intercepts. As a glimpse ahead beyond this book, let's look at how determinants get more complex as the matrix grows. Take a  $3 \times 3$  matrix where the eqns are planes having the form  $ax + by + cz = d$ .

$$\begin{array}{ccc} 1 & 5 & 3 \\ 2 & 4 & 7 \\ 4 & 6 & 2 \end{array}$$

I'll just show the set-up and you can see the  $2 \times 2$  det in the  $3 \times 3$  in each step and then do the math. The  $3 \times 3$  determinant uses each term in the top row times the corresponding  $2 \times 2$  dets below. The signs of the terms to get the  $3 \times 3$  det alternate pos to neg.

$$\det = 1(4 \cdot 2 - 6 \cdot 7) - 5(2 \cdot 2 - 7 \cdot 4) + 3(2 \cdot 6 - 4 \cdot 4)$$

If this is not equal to zero, then the planes meet at a point. There is much more to matrix arithmetic and determinants. And these lead into vector spaces which I especially enjoy. If we had given the three planes as  $ax + by + cz = d$  with their d's filled in, you could use the same method as above with a  $3 \times 4$  instead of a  $2 \times 3$  matrix to find the three dimensional point  $(x,y,z)$  where they intersect. But the point of all this is that the matrix method is very useful in solving simultaneous  $1^\circ$  eqns.

Let's look a little more at  $1^\circ$  eqns geometrically. If we have one point on the line  $(x_1, y_1)$  and the slope  $m$ , we know that the slope is the change or difference in vertical change over the change or difference in horizontal change. (Diagram?) So  $m = (y - y_1)/(x - x_1)$ . From this we have  $(y - y_1) = m(x - x_1)$ . Therefore,

$$\begin{array}{l} y = m(x - x_1) + y_1 \\ y = mx - mx_1 + y_1 \\ y = mx + (y_1 - mx_1) \end{array}$$

where  $m = (y - y_1)/(x - x_1)$ .

It looks like a mess but plug in some numbers at the beginning and it's simple. When we solve  $ax + b = c$  we have an eqn of condition and ask what  $x$ 's make the LHS equal to  $c$ . When we solve  $ax + b = 0$ , we are solving for the **root** where the line intersects the  $x$ -axis. And we know this is  $-b/a$  which plugged into  $ax + b = 0$  gives zero on both sides. Some easy theorems with simple proofs building on this idea:

**Theorem I** If  $x_1$  is the root of  $ax + b$  then  $\forall x, ax + b = a(x - x_1)$ .

**Proof**

$$ax + b = a(x + b/a) = a(x - (-b/a)) = a(x - x_1) \blacksquare$$

**Theorem II**  $ax + b$  is the same sign as  $a$  when  $x > \text{root } x_1$  and opposite sign when  $x < x_1$ .

**Proof**

$$ax + b = a(x - x_1) \quad (\text{Thm I})$$

$$x > x_1 \therefore x - x_1 > 0$$

$$\therefore a(x - x_1) > 0$$

$$\text{Sym. } x < x_1 \therefore a(x - x_1) < 0 \blacksquare$$

In proofs, you know that Sym. or "symmetrically" means that the same pattern of argument is used to produce the given results. It is a justified and practical expression of laziness whenever it does not destroy clarity. Destroying clarity through laziness is evil.

If in a line, our given point  $(x_1, y_1)$  is  $(0, 2)$  and our slope or  $m = 3$ , our  $y = mx + (y_1 - mx_1)$  becomes  $y = 3x + 2$ . What if we had  $(x_1, y_1)$  and  $(x_2, y_2)$  to begin with and needed the line?

$y = mx + c$	[1]	(general expression)
$y_1 = mx_1 + c$	[2]	(line at point 1)
$y_2 = mx_2 + c$	[3]	(line at point 2)
$y - y_1 = m(x - x_1)$	[4]	(1 - 2)
$y_2 - y_1 = m(x_2 - x_1)$		(3 - 2)
$\therefore m = (y_2 - y_1)/(x_2 - x_1)$	[5]	
$y - y_1 = ((y_2 - y_1)/(x_2 - x_1))(x - x_1)$		(sub 5 into 4)

This is our line derived from two points. If these are  $(0, 2)$  and  $(-2/3, 0)$ , then the line is

$$\begin{aligned} y - 2 &= (2-0)/(0 - (-2/3))(x - 0) \\ y - 2 &= 3x \\ y &= 3x + 2 \end{aligned}$$

These two points were the lines  $y$ - and  $x$ -intercepts. We can use Euclid to do the same:

$$y \text{ intercept} = b = BA$$

$$x \text{ intercept} = a = AC$$

Because  $AB \parallel PD$ :  $\Delta ABC$  similar  $\Delta DPC$

$$\therefore AB : PD :: AC : DC \quad (\text{Euclid 6.2})$$

$$\therefore b : y :: a : a-x$$

$$\therefore b(a-x) = ay$$

$$\therefore ba - bx = ay$$

$$\therefore b - (bx)/a = y$$

$$\therefore 1 - x/a = y/b$$

$$\therefore x/a + y/b = 1$$

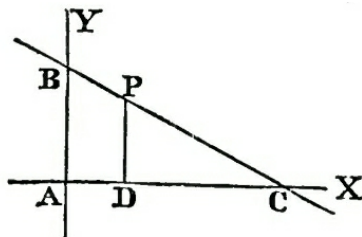

Similar triangles have the same angles and are proportional. Remember this final form when we get to our field guide to conic sections.

If we take our previous line in this form, we have:

$$\begin{aligned}x/(-2/3) + y/2 &= 1 \\-3/2 x + 1/2 y &= 1 \\-3x + y &= 2 \\y &= 3x + 2\end{aligned}$$

In Theorem II, when  $x = \text{root } x_1$  this  $x_1$  is the  $x$ -intercept. When  $x$  is greater or less than the root, all the  $y$ 's are above or below the  $x$ -axis, depending on the  $a$  in the theorem. You should be able to quickly establish in your mind the intercept and slope -- the form -- of any line. The algebraic form and the geometric form are simply two expressions of the form of number wrt lines. If you will play with the algebra and geometry of lines, you can prove to yourself that given  $y = mx + c$ , all lines perpendicular to it have slope  $-1/m$ . You can take any theorem about lines like our Thm I, apply it to a specific line, and use the resulting image to establish the general truth of the theorem.

## Second Degree Equations

When we move from first degree equations to second degree equations, our geometry changes from a line to a curve. The simplest of these are **quadratics** which take the forms:

$$\begin{aligned} ax^2 + b &= 0 \\ ax^2 - b &= 0 \\ ax^2 + bx + c &= 0 \\ ax^2 - bx + c &= 0 \\ ax^2 + bx - c &= 0 \\ ax^2 - bx - c &= 0 \end{aligned}$$

The general form here is  $ax^2 + bx + c$  where  $a, b, c \in \mathbf{R}$ . When we set these functions equal to 0, we are solving for roots, just as with lines. Or we can treat them as functions, e.g.  $f(x) = y = ax^2 + b$ , calculate various  $y$  coordinates from chosen  $x$  coordinates and then diagram or **graph** the eqn as we did for lines. Again,  $x$  is the ind.var. and  $y$  is the dependent var.

$$\begin{aligned} \text{Consider the expression } f(x) &= ax^2 - bx + c && [1] \\ \text{We've defined the roots of } f(x) &\text{ as those } x \text{ for which } f(x) = 0. \\ \text{Let } m \text{ be a root } \therefore am^2 - bm + c &= 0 && [2] \end{aligned}$$

$$\begin{aligned} \text{Subtract [1] from [2] and } f(x) &= a(x^2 - m^2) - b(x - m) \\ &= (x - m)(a(x + m) - b) \end{aligned}$$

So  $x - m = 0$  gives root  $m$  and  $a(x + m) - b = 0$  gives another. Let it be  $n$ .

Then  $n + m = -b/a$  or  $b = a(n + m)$ . Sub this  $b$  into [2]

Then  $am^2 - am(n + m) + c = 0 \therefore c - amn = 0 \therefore amn = c \therefore mn = c/a$

$$\begin{aligned} \text{Sub our new } b, c \text{ into [1]: } f(x) &= ax^2 - a(m + n)x + amn \\ &= a(x^2 - (m + n)x + mn) \\ &= a(x - m)(x - n) \end{aligned}$$

The roots are  $m, n$  where  $a, b, c, m, n \in \mathbf{R}$

Here is another way to look at quadratics.

$$\begin{aligned} y &= ax^2 - bx + c && [ \times 4a ] \\ 4ay &= 4a^2x^2 - 4abx + 4ac && [ \pm b^2 ] \\ 4ay &= 4a^2x^2 - 4abx + b^2 + 4ac - b^2 \\ &= (2ax - b)^2 + (4ac - b^2) \end{aligned}$$

Here we have three cases:

I.

$$\begin{aligned} b^2 &> 4ac \text{ or } b^2 - 4ac > 0 \\ \text{Let } b^2 - 4ac &= k^2 > 0 \\ (2ax - b)^2 - k^2 &= 0 \\ (2ax - b)^2 &= k^2 \\ 2ax - b &= \pm k \\ x &= b \pm k = (b \pm \sqrt{(b^2 - 4ac)})/2a \end{aligned}$$

If we take the + of  $\pm$ ,  $x = m$ , if the -,  $x = n$ . Going back to  $ax^2 - bx + c = a(x - m)(x - n) \therefore$

$$= a \left( x = \frac{(b + \sqrt{(b^2 - 4ac)})}{2a} \right) \left( \frac{(b - \sqrt{(b^2 - 4ac)})}{2a} \right) \quad [1]$$

$\therefore$  Because  $b^2 - 4ac > 0$ ,  $m$  and  $n$  are positive.

Is something bothering you? The  $4ay$ ? We cannot ever make  $4a$  equal to zero. So we are showing where  $y$  is equal to zero.

II.

$$\begin{aligned} b^2 &= 4ac \text{ or } b^2 - 4ac = 0 \therefore k = 0 \therefore m, n = b/(2a) \\ \therefore f(x) \text{ ax}^2 - bx + c &= a(x - m)(x - n) = a(x - (b/(2a)))^2 \\ \therefore m, n &\geq < 0 \text{ as } b/(2a) \geq < 0 \end{aligned}$$

III.

$$b^2 < 4ac \text{ or } b^2 - 4ac < 0 \therefore k^2 < 0$$

If we run the algebra on this case, we get:

$$\begin{aligned} x &= (-b \pm \sqrt{(b^2 - 4ac)})/2a \\ &= (-b \pm \sqrt{-(k^2)})/2a \end{aligned}$$

If  $k = 3$ , we have  $(-b \pm \sqrt{(-9)})/2a$ . In the Trigonometry section, we will deal more fully with the idea of the square root of negative one. In any case, no real number squared is less than zero. So there are no square roots of negative numbers. Long story short:

If we say  $\sqrt{(-9)} = \sqrt{(-1 \times 9)}$  and say that  $\sqrt{-1} = i$  then  $\sqrt{(-9)} = 3i$ . Then the roots with this form of  $\sqrt{-1}$  take the forms of  $x + iy$  and  $x - iy$ . Without this idea, we could only have roots on the  $x$ -axis of real numbers and would wonder (as was actually done) what the heck we should do with these **imaginary** roots. But if we let  $i = 1$  on the  $y$ -axis and  $-i = -1$  on the  $y$ -axis, then  $x + iy$  and  $x - iy$  become as representable as  $(x, y)$  and  $(x, -y)$  on the plane. And now all eqns have representable roots and from this "i" springs Complex Analysis. These kinds of numbers are called **complex numbers** denoted in total as **C**. **R** is a subset of **C**. Or further, we can say **N**  $\subset$  **Z**  $\subset$  **Q**  $\subset$  **R**  $\subset$  **C**.

This  $ax^2 - bx + c$  is only one form of quadratic. When it takes the form  $x^2 - ax + b$  it is a quadratic solvable by Euclidean geometry. If  $a$  and  $b$  are constructible (look this up if you're interested) then the roots are constructible.

### Theorem

Given  $ax^2 - bx + c$

$\odot$  diam BQ: B = (0,1) Q = (a,b)  $\therefore$  roots ON, OM

### Proof

Center  $\odot = (a/2, (b+1)/2)$

$BQ = a^2 + (b - 1)^2$

$\therefore \odot = (x - a/2)^2 + (y - (b + 1)/2)^2 = (a^2 + (b-1)^2)/4$

which reduces to  $x^2 - ax + b$  when  $y = 0$

$\therefore$  roots ON, OM

If  $\odot$  is tangent to OX,  $OM = ON$

If  $\odot$  doesn't intersect OX or Q = B, roots imaginary

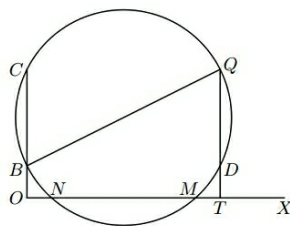

Let's look at the general form of  $ax^2 + bx + c$  where  $a, b, c \in \mathbf{R}$

$$ax^2 + bx + c = 0$$

$$ax^2 + bx = -c$$

$$x^2 + b/a \cdot x = -c/a$$

$$x^2 + b/a \cdot x + b^2/4a^2 = -c/a + b^2/4a^2$$

$$(x + b/2a)^2 = -c/a + b^2/4a^2$$

$$x + b/2a = \pm(\sqrt{(b^2 - 4ac)}/2a)$$

$$x = (-b \pm \sqrt{(b^2 - 4ac)})/2a = m, n \quad [1]$$

And we arrive at our former result. This has been a brief history of thought wrt quadratics. It began as early brute force geometric algebra using Euclid. It evolved into an awareness of a more general case of  $ax^2 - bx + c$ . Then came a long struggle over  $\sqrt{-1}$  which eventually became a harmonious expansion of mathematics. The general cases of  $b^2 - 4ac$  were understood and this opened the way for a truly general case of  $ax^2 + bx + c$ . The result [1] is the **quadratic eqn** and the general solution for all  $f(x)$  taking this general form.

Just by considering this general form and its result, we can say:

1. If  $b^2 - 4ac > 0$ , then roots  $m, n \in \mathbf{R}$ ;
2. If  $b^2 - 4ac = 0$ , then  $m = n$  and the root is real;
3. If  $b^2 - 4ac < 0$ , then  $m, n \in \mathbf{C}$ ; and
4. If  $\sqrt{(b^2 - 4ac)} \in \mathbf{Q}$ , then roots  $\in \mathbf{Q}$ .

Verify these by an example. We can also see the  $m+n = -b/a$  and  $mn = c/a$  and if we start with  $ax^2 + bx + c$ , these are the coeffs of  $x^2 + b/a x + c/a$ . See if you can prove for yourself the following four propositions regarding signs:

1.  $ax^2 + bx + c$  : any real roots are negative;
2.  $ax^2 - bx + c$  : any real roots are positive;
3.  $ax^2 + bx - c$  : roots are real, one pos., one neg.,  $|\text{neg}| > |\text{pos}|$ ; and
4.  $ax^2 - bx - c$  : real roots, one pos., one neg.,  $|\text{pos}| > |\text{neg}|$ .

Also consider  $(x - m)(x - n)$ . If these have the same sign, their product is positive; if of different sign, product is negative. And this case can only happen if  $x$  is greater than one and less than the other:  $m < x < n$  or  $n < x < m$ . If we then consider  $a(x - m)(x - n)$ , we see that these observations hold if  $a > 0$  and are reversed if  $a < 0$ . Also take the time to establish why, if beginning with  $ax^2 + bx + c$  we end up with  $a(x - m)(x - n)$  where  $a$  is just this constant.

If  $c = 0$  then  $ax^2 + bx + c = x(ax + b)$  and roots are  $x, -b/a$ . If  $b = 0$ , then  $ax^2 + c$  gives a root of  $x = \pm\sqrt{-c/a}$  which is real or complex. If  $a = 0$ , we have  $x = -c/b$ . But if we put  $bx + c$  into [1], we get roots  $0/0$  and  $-2b/0$ . In this case, if our eqn is a representation,  $0/0$  may indicate that only  $-c/b$  is a soln and  $-2b/0$  may indicate that larger and that larger values of  $x$  more nearly provide some practical soln in the world of experience.

Let us make a first pass at the idea of  $\sqrt{-x}$  wrt quadratics. Later, we will deal with this in depth. First we can show a context in which it is absurd. If we divide  $a$  into two parts, equal or not, we have  $a/2 + x$  and  $a/2 - x$ . Their product is  $a^2/4 - x^2$ . If we want the maximum result,  $x$  must be 0 which is to say  $a$  is divided exactly in two:

$$\text{max value} = a^2/4 \quad [1]$$

Let us divide  $a$  into  $x, x-a$  such that their product is  $b$ . Their product is  $ax - x^2$ .

$$\begin{aligned} \therefore ax - x^2 &= b \\ \therefore x^2 - ax + b &= 0 \end{aligned}$$

So the soln is:

$$(a \pm \sqrt{(a^2 - 4b)})/2 = a/2 \pm \sqrt{(a^2/4 - b)}$$

From [1], if  $b > a^2/4$  then  $(a^2/4 - b)$  is negative. Call this  $-c$ .

Then it is absurd to think that we can find a quantity equal to  $\sqrt{-c}$  to add or subtract from  $a/2$ . We can also observe that roots with  $\sqrt{-x}$  appear only in pairs. If  $b^2 - 4ac = k$ , roots are  $(-b \pm \sqrt{-k})/2$ .

Absurdity in mathematics can be a matter of context. In the context of quantity, there is no  $-3$  and no  $\sqrt{-3}$ . But in the context of Analytic Geometry or Complex Analysis both of these values have meaning. They are correct and consistent indications of position in the problem space. But they cannot enter into the sphere of quantity.

Unlike a negative number in a word problem or the arisal of  $a/0$  or  $0/0$ , the arisal of  $\sqrt{-a}$  does not indicate a misstatement of the problem. Instead, it shows that the solution space is **C**, a superset of **R**. If in practice a real solution is required, a soln of only complex values would -- in practice -- indicate **no** solution.

Related to this idea is the idea of the **nth roots of unity** which we will also consider again in more depth. Let's take a brief first look. In  $x^n - 1 = 0$  or  $x^n = 1$ , there must be  $n$  roots such that  $x^n = 1$ .

$$\begin{aligned} n = 1: x &= 1 \quad (\text{or } 1^1 - 1 = 0) \\ n = 2: x^2 &= 1 \quad \therefore x = \pm 1 \\ n = 3: x^3 &= 1 \\ &1^3 \text{ is clearly } 1 \text{ so } 1 \text{ is a root} \\ &x^3 - 1 = (x - 1)(x^2 + x + 1) \\ &1 \text{ is the root of the 1st factor} \\ &2d \text{ factor quadratic} \Rightarrow \text{roots } (-1 \pm \sqrt{-3})/2 \\ &(\text{Check this by raising each to the third power.}) \\ n = 4: x^4 - 1 &= (x^2 - 1)(x^2 + 1) \\ &1st \text{ factor roots: } \pm 1 \\ &2d \text{ factor roots: } \pm\sqrt{-1} \text{ and we call these } \pm i \\ &i^1 = i \\ &i^2 = -1 \\ &i^3 = -i \\ &i^4 = 1 \text{ and repeat} \end{aligned}$$

We will see the  $n$ th roots of unity again the the Trigonometry section. They arise in geometry, algebra, complex analysis, and many other fields. Finally, let's note that other eqns can take the form of a quadratic and so can be similarly solved.

$$\begin{aligned} 1) \quad &x^4 + 4x^2 + 3 \quad (\text{solve for } x^2 \text{ as quadratic}) \\ &\therefore x^2 = -1, -3 \\ &\therefore x = \pm i, \pm i\sqrt{3} \end{aligned}$$

In the solution here for  $i$ ,  $i^4 = 1$ ,  $i^2 = -1 \therefore 1 - 4 + 3 = 0$ .

$$2) \quad x^2 - 3x + 1 = 2 - \sqrt{(x^2 - 3x + 1)}$$

If you square both sides and simplify you can solve  $x^4 - 6x^3 + 6x^2 + 9x = 0$  or you can treat the whole thing as a quadratic which is much less of a headache:

$$(x^2 - 3x + 1) + \sqrt{(x^2 - 3x + 1)} - 2 = 0$$

If  $v = \sqrt{x^2 - 3x + 1}$ , then this is  $v^2 + v - 2 = 0$  and  $v = 1, -2$ . This gives us:

$$\begin{aligned}\sqrt{x^2 - 3x + 1} &= 1 \\ x^2 - 3x + 1 &= 1 \\ x^2 - 3x &= 0 \\ x &= 0, 3\end{aligned}$$

$$\begin{aligned}\sqrt{x^2 - 3x + 1} &= -2 \\ x^2 - 3x + 1 &= 4 \\ x^2 - 3x - 3 &= 0 \\ x &= (3 \pm \sqrt{21})/2\end{aligned}$$

And these are the four roots of the above 4<sup>o</sup> eqn. De Morgan provides very few exercises. Here is an interesting one of his:

*Show that  $a + 1/a$  cannot be a real number less than 2. Prove this by showing that the roots of*

$$a + 1/a = 2 - p$$

*are purely complex when  $0 < p < 4$ . It may also be shown from  $(a - 1)^2$  being always positive.*

For De Morgan, "real number" was "numerical," "complex" was "symbolical," and "shown" was "shewn." These have been updated.



## Limits

In De Morgan's day, the concept of limit was a subset of what became Weierstrass's definition of limit which we use today:

$f(x)$  has a limit  $\mathbf{a}$  as  $x \rightarrow \infty$  if for  $\forall \epsilon > 0, \exists k > 0$ :  
if  $|f(x) - \mathbf{a}| < \epsilon$  then  $|x| < k$

Older definitions considered only simple continuous functions where the graph was a continuous line. Weierstrass's definition allows us to consider fns (functions) which are not continuous. If a fn took the form of a continued fraction, it would not approach its existing limit in a continuous line but would jump back and forth, always closer and closer to the limit. The progress of the idea of limit expanded and clarified the idea, leaving these limits of De Morgan's still intact.

If  $x - 2 = 0$ , we can apply algebra in two different ways to get  $x^2 - 4 = 0$  and  $x^2 - 2x = 0$ :

$$\begin{aligned} \therefore x^2 - 4 &= x^2 - 2x \\ \therefore (x + 2)(x - 2) &= x(x - 2) \\ \therefore x + 2 &= x \\ \text{But } x - 2 &= 0 \\ \therefore x &= 2 \\ \therefore 4 &= 2 \end{aligned}$$

You saw that coming, right? Here the anomaly arises by unknowingly dividing by zero. Can you determine where? But even if  $x - 2 = \epsilon$  where  $\epsilon = (1/10^{271})$ , the same anomaly would arise. You would, by the above logic, have 2 and 4 as nearly equal, as differing only by  $\epsilon$ . When you are dividing each side by  $(x - 2)$  or  $\epsilon$ , you are multiplying each side by  $1/0$  or  $1/\epsilon$ . So any tiny difference in  $x^2 - 4$  and  $x^2 - 2x$  is considerably magnified. If  $x - 2 = \epsilon$  then  $x^2 - 4$  and  $x^2 - 2x$  are not equal and one could be much larger or *[a]n elephant and a gnat are both small fractions if the whole earth be called 1, but they are not nearly equal in any sense*. So equality is then defined as:

$$a = b \Leftrightarrow a - b = 0 \vee a/b = 1$$

This reads "a equals b if and only if a minus b equals 0 or a divided by b equals one. This "if and only if" or " $\Leftrightarrow$ " means each side implies the other. LHS implies both the elements of RHS and either element of RHS implies the LHS. Here is the important idea without the elephant and gnat:

*Approach toward equality is measured not by the diminution of the difference but by the approach of this quotient to unity.*

From this follows:

### Theorem

The value of a fraction depends entirely upon the relative, not on the absolute, value of the terms.

### Example

Follows from  $ma/mb = a/b$

Req: Find two fractions  $a/b$  each less than a given  $x: a/b = m$

Soln: take any 2 numbers  $p, q: p < xq$ . Then  $a = p/q, b = p/mq$ . Test with any  $x$  and  $m$ .

Def. **limit**  $\equiv$  When, under certain circumstances, or by certain suppositions, we can make  $A$  as near as we please to  $P$  ( $A$  being a quantity which changes its value ... and  $P$  a fixed quantity) then  $P$  is the limit of  $A$ .

This is very nearly Cauchy's definition of limit as immediately preceding Weierstrass. Cauchy's definition is, in fact, still used in certain cases. What bothered everyone was that everywhere a limit appeared you were forced to say "as near as we please" or "howsoever big one chooses" and something more mathematical-sounding was wanted. If you look carefully at Weierstrass's definition you can see 1) how he satisfied this desire and 2) where he hid the "as you please." So while we no longer speak of our pleasures regarding limits our **behavior** is largely unchanged since De Morgan's time.

If we can make a quantity as great as we please, it **increases without limit** or  $x \rightarrow \infty$ . If we can make it as small as we please, it **decreases without limit** or  $x \rightarrow 0$ . If  $x \rightarrow 0$ , then the limit of  $x + a$  is  $a$ . If the limit of  $x$  were  $a$  in some context, the limit of  $x + a$  is  $2a$ . If  $x \rightarrow 0$ , then  $1/x \rightarrow \infty$ . The limit is a way of consistently handling  $0$ ,  $1/0$ ,  $0/0$  whenever they arise. And they rise like a zombie apocalypse in the Calculus. Limit gives a sense to  $(1/(x-a))^{(x-a)/a}$  when  $x = a$  and the expression becomes  $(1/0)^{0/0}$ . The following theorems are De Morgan's way of introducing the technique of finding limits.

### Theorem I

If  $A$  and  $B$  are two expressions in  $x$  which are always equal, so long as they preserve an intelligible form, then the limits of  $A$  and  $B$  are equal.

#### Proof

Let  $x \rightarrow \infty$   $A \rightarrow P$   $B \rightarrow Q$  then  $P$  must equal  $Q$ .

Suppose  $A = P + a$  and  $B = Q + b$ . Then  $x \rightarrow \infty$  and  $a, b \rightarrow 0$ .

Else if  $a \rightarrow \alpha$  then  $A \rightarrow P + \alpha$ .

But  $A \rightarrow P \therefore a \rightarrow 0$

$A = B \therefore P + a = Q + b$

Else  $P \neq Q$ . Let  $P > Q \therefore P = Q + R$

$P, Q$  do not contain  $x$

$\therefore R$  does not contain  $x \therefore x \rightarrow 0$

$P, Q, R$  constant  $\therefore Q + R + a = Q + b \therefore R = b - a \neg$  (absurd as  $b - a \rightarrow 0$  as  $x \rightarrow \infty$ )

$\therefore P = Q$  ■

That proof should be within your capabilities now. The "Else" tags mark the beginning of proof by contradiction and each usually ends with a " $\neg$ ". So where does the first "Else" end? Why is it that  $P, Q$  do not contain  $x$ ? Why does it follow that  $R$  does not contain  $x$ ?

### Theorem II

When  $x \rightarrow 0$  the limit is found by making  $x = 0$  given 1) that the result has sense and 2) there are no infinite terms.

#### Example (Not Proof)

In  $1 + 2x + x^2$ , if  $x \rightarrow 0$  then  $1 + 0 + 0$  is the limit.

But in  $1 + x + x^2 + x^3 + \dots$  we cannot simply on appearances say what the infinite sum of the  $x$ 's will be.

Theorems and propositions (which, as far as I can tell are the same thing) require proof. But De Morgan knows that at this point you aren't ready for a proofs of some of these. He (and I) are helping you learn mathematics.

*We learn mathematics by doing mathematics.*

**Theorem III**

When  $x \rightarrow \infty$  we know that  $1/x \rightarrow 0$ .

**Example**

Let  $v = 1/x \therefore x = 1/v$ .

$A = (x + 1)/(3x - 2)$  Let  $x = 1/v$

$$\frac{1/v + 1}{3/v - 2} = \frac{(1/v + 1) \cdot v}{(3/v - 2) \cdot v} = \frac{1 + v}{3 - 2v}$$

$\therefore$  If  $x \rightarrow \infty$  then  $v \rightarrow 0$  and  $A \rightarrow 1/3$

That was an extremely useful technique for finding limits. Here is another cool technique and I say "cool" because I think it **is** cool. I love discovering new techniques in algebra. They are not "tricks" and, Todhunter to the contrary, they are not "algebraic artifices." They are our growing dominion over mathematics.

**Theorem IV**

If  $a > 1$  then as  $n \rightarrow \infty$ ,  $a^n \rightarrow \infty$

**Proof**

$$a^2 = a + a^2 - a = a + a(a - 1) \quad (\text{technique: a new use for } a = a - b + b - \dots)$$

$$a^3 = a^2 + a^2(a - 1)$$

...

$$a^n = a^n + a^n(a - 1) \quad (\text{Now comes the use of the technique})$$

$$a > 1 \therefore (a - 1) > 0 \therefore a(a - 1) > 0$$

$$a^2 > a \therefore a^2(a - 1) > a(a - 1) \text{ and so on} \quad (\text{as in line above with } a^3, a^4, \dots)$$

$\therefore$  If  $n \rightarrow \infty$  then  $a^n \rightarrow \infty$  as each  $n$  is larger than  $n-1$

**Theorem V**

If  $b < 1$ , if  $n \rightarrow \infty$  then  $b^n \rightarrow 0$

**Proof**

Let  $b = 1/a$  then  $b^n = 1/a^n$

$$b < 1 \therefore 1/b = a > 1 \therefore a^n \rightarrow \infty \quad (\text{Thm IV})$$

$$\therefore 1/a^n = b^n \rightarrow 0$$

The way to view simple proofs is to be grateful when they come along. Many larger proofs could be simplified if the author made the effort. Just as there is no virtue in unreadably simple C-code, there is no virtue in making the truth opaque either. While the above theorems are important, the next one deserves all your attention. Make sure you follow the reasoning in this proof.

**Theorem VI**

If  $0 < x < 1$  the series  $(1 + x)$ ,  $(1 + x + x^2)$ ,  $(1 + x + x^2 + x^3)$ , ... has a limit of  $1/(1-x)$ . Or each term is closer to, and never exceeds  $1/1-x$ . So we can restate the theorem as:

$$\text{If } x \in (0,1) \text{ then } 1/(1-x) = 1 + x + x^2 + x^3 + \dots$$

**Proof**

If  $x > 0$  then the terms  $1$ ,  $(1 + x)$ ,  $(1 + x + x^2)$ , ... monotonically increase.

Term  $(n + 1) = x(\text{term } n) + 1 \therefore$  terms have form:  $1$ ,  $1 + x$ ,  $1 + x(1 + x)$ ,  $1 + x(1 + x + x^2)$ , ...

$\therefore$  If  $A$  any term,  $B$  next term, then  $B = 1 + Ax$

$B > A \therefore 1$  more than compensates the loss of  $A$  by multiplication with  $x \in (0,1)$

$$Ax = A + Ax - A = A - (1 - x)A \quad (A \cdot x \text{ diminishes } A \text{ by } (1-x) \cdot A)$$

$\therefore 1/1-x > A$  and  $A$  is any term.

Now we prove each term approaches  $1/1-x$  more closely or  $x \rightarrow \infty$ ,  $1 + x + x^2 + \dots \rightarrow 1/1-x$

$$\text{Let } 1/1-x - A = p \therefore A = 1/(1-x) - p \quad [\text{Cont'd}]$$

Next term  $1 + x/(1-x) - px = 1/(1-x) - px$

Next term  $1/(1-x) - px^2$

( validate this if you can't see it )

Next term  $1/(1-x) - px^3$  and so on

$p$  is constant,  $x^n < x^{n-1} \therefore 1 + x + x^2 + \dots \rightarrow 1/1-x$  ■

As the next low hanging fruit, we have  $1 - x + x^2 - x^3 + \dots$  where sym. A,B are consecutive terms again.

$B = 1 - Ax = 1 + A - A(1 + x)$  or

$B = A + 1 - A(1 + x)$

Next term  $C = B + 1 - B(1 + x)$

In this form,  $B > A$ ,  $C < B$  or

$1 > A(1 + x)$  and  $1 < B(1 + x)$  or

$1/1+x > A$  and  $1/1+x < B$  and so on alternately

$\therefore 1 > 1/(1+x)$

$1 - x < 1/(1+x)$

$1 - x + x^2 > 1/(1+x)$  and so on. (alternating approach to limit, re Weierstrass)

$\therefore 1 - x + x^2 - \dots \pm x^{n-1}$  is term  $(n - 1)$

$\therefore 1 - x + x^2 - \dots + (-1)^{n-2} x^{n-1} + (-1)^{n-1} x^n$  is term  $(n)$

and these consecutive terms differ by  $x^n$  and as  $n \rightarrow \infty$   $x \rightarrow 0$  ( $x \in (0,1)$ )

$\therefore 1/1+x = 1 - x + x^2 - x^3 + \dots$

### Theorem VII

If both num and denom of a fraction diminish without limit, the fraction can go to 0,  $\infty$ , or a finite limit.

**Proof** (or Example -- you decide)

$(x^2 - a^2)/(x - a)^2$   $(x^2 - a^2)/(x - a)$

$(x - a)^2/(x^2 - a^2)$

If  $x = a$ , all equal 0/0. But simplify them:

$(x + a)/(x - a)$   $x + a$

$(x - a)/(x + a)$

When  $x \rightarrow a$ , limits left to right are  $\infty$ ,  $2a$ , 0.

### Theorem VIII

The same is true where num and denom increase without limit.

**Proof**

Let  $A/B$  be such a fraction, then  $A/B = (1/B)/(1/A)$  and Thm VII shows that these also have limits of  $\infty$ , 0, or any finite value.

### Theorem IX

The same is true of products  $AB = A/(1/B)$  where  $A \rightarrow 0$  and  $B \rightarrow \infty$ . Then the limit again cannot be predicted as it takes the form 0/0.

**Proof**

Exercise for the reader by showing some examples.

Consider the limit of  $a^x$  as  $x \rightarrow 0$ .

$x = 1/y$  then  $x \rightarrow 0$  as  $y \rightarrow \infty \therefore a^x = a^{1/y} = \sqrt[y]{a}$

**1) If  $a > 1$**  then all roots  $> 1$

$\therefore \sqrt[y]{a} = 1 + v$  or  $a = (1 + v)^y$

$y \rightarrow \infty$  then  $v \rightarrow 0$  ( and we prove by contradiction )

Else  $v$  always  $\geq k \therefore 1 + v = 1 + k$

But  $y \rightarrow \infty$  then  $(1 + k)^y \rightarrow \infty$  ( Thm IV )

$\therefore (1 + k)^y > a \therefore (1 + v)^y > (1 + k)^y > a$  But  $a = (1 + k)^y \rightarrow \infty$  ( so what is the contradiction? )

$\therefore y \rightarrow \infty$  then  $v \rightarrow 0 \therefore 1 + v = 1$

$\therefore$  As  $x \rightarrow 0$  then  $\sqrt[y]{a} = a^{1/y} = a^x \rightarrow 1$  ( note that  $a^0 = 1$  )

2) If  $a < 1$  then  $1/a > 1 \therefore \sqrt[y]{(1/a)} \rightarrow 1 \therefore \sqrt[y]{(1/a)} = 1/\sqrt[y]{a} \rightarrow 1/1 = 1$

Proofs are always an exercise in sustained reasoning and patience. This does not rely upon natural talent. It relies upon your developing your mind. As with Thm VI, the next theorem repeatedly pops up as we progress.

Def. **rational integral expression**  $\equiv$  any sum of the form  $ax^n + bx^{n-1} + \dots + cx + d$  where the coeffs  $(a,b,\dots,c,d) \in \mathbf{Q}$ .

**Theorem X**

Let  $f(x)$  be a rational integral expression:  $x^n$  highest power of  $x$ . If  $x \rightarrow \infty$  then the  $x^n$  term can contain the sum of the remaining terms infinitely many times.

**Example** ( or Proof? What do you think? )

In  $ax^3 + bx^2 + cx + d$ ,  $a$  can be tiny and  $b,c,d$  huge

But  $x$  can be taken so large that  $ax^n$  can contain  $n(bx^2 + cx + d)$  as  $n \rightarrow \infty$ .

$$ax^3/(bx^2 + cx + d) = ax/(b + c/x + d/x^2).$$

Let  $c/x + d/x^2 = p$ .

Then as  $x \rightarrow \infty$ ,  $p \rightarrow 0$

$\therefore ax^3$  contains the remainder  $ax/(b+p)$  greater than  $ax/(b+1)$  times and

as  $x \rightarrow \infty$ ,  $ax/(b+1) \rightarrow \infty$

**Theorem XI**

The same is true if in any rational integral  $f(x) \rightarrow 0$ , the least power of  $x$  can contain the remainder of  $f(x)$  infinitely many times.

**Proof**

This can be shown by a sym. argument to the above which should be well within your powers by now. Keep in mind that you must try and (at least partially) fail many times before you can naturally do something well.

Always keep in mind that infinity or " $\infty$ " is **not a number**. It is identical with "and so on" or "... " and that makes it an adverb. Going back to Thm VI and to algebraic division, let's look at  $1/1+x$ . In one way we get:

$$\begin{aligned} 1 + x & \Big| 1 ( x + x^2 + \dots \\ & \quad \underline{x + x^2} \\ & \quad 1 - x - x^2 \\ & \quad \quad \underline{x^2 + x^3} \\ & \quad \quad 1 - x - 2x^2 - x^3 \\ & \quad \quad \quad \dots \end{aligned}$$

And in another way, we can get:

$$\begin{aligned} 1 + x & \Big| 1 ( 1 - x + x^2 - \dots \\ & \quad \underline{1 + x} \\ & \quad -x \\ & \quad \quad \underline{-x - x^2} \\ & \quad \quad \quad x^2 \\ & \quad \quad \quad \underline{x^2 + x^3} \\ & \quad \quad \quad \dots \end{aligned} \quad \text{and } 1 - x + x^2 - (-x^3/(1+x)) = 1/1+x$$

We can do the same thing where  $1 + x + x^2 + \dots + x^n + x^{n+1}/1-x = 1/1-x$ . You can verify these for yourself. So you can determine what the infinite series is for both  $1/(x+1)$  and  $1/(1-2x+x^2)$  and determine what restrictions must be placed on  $x$  if either is to have a limit. Determine why  $1/(x+1)$  differs from  $1/(1+x)$  in this expansion.

Here, no one will tell you if your results are right or wrong. This is mathematics and **you are responsible** for the **truth** of your own results. In the next chapter we will learn to think of these results as infinite series and their infinite sums and determine when the latter has a finite value or limit.

Here is an example of the power of the last two chapters:  
We saw that the roots of  $ax^2 + bx + c$  when  $a = 0$  are

$$\frac{-b + \sqrt{(b^2 - 4ac)}}{2a} = \frac{-b + b}{2 \cdot 0} = \frac{0}{0}$$

$$\frac{-b - \sqrt{(b^2 - 4ac)}}{2a} = \frac{-b - b}{2 \cdot 0} = \frac{2b}{0} \quad (\times -1/-1)$$

But  $bx + c = 0 \therefore x = -c/b$

We use the form  $x^2 - y^2$  and the idea of limits.

First we show that  $\sqrt{(b^2 + v)} \rightarrow b + v/2b$

$$(b + v/2b + \sqrt{(b^2 + v)})(b + v/2b - \sqrt{(b^2 + v)})$$

$$= (b + v/2b)^2 - (b^2 + v)$$

$$= b^2 + 2bv/2b + v^2/4v^2 - b^2 - v$$

$$= b^2 + v + v^2/4b^2 - b^2 - v = v^2/4b^2$$

$$\text{Now } (x + y)(x - y) = x^2 - y^2 \therefore x - y = (x^2 - y^2)/(x + y)$$

$$\therefore b + v/2b - \sqrt{(b^2 + v)} = (v^2/4b^2)/(b + v/2b + \sqrt{(b^2 + v)})$$

In denom as  $v \rightarrow 0$  the denom  $\rightarrow 2b$ . So as it diminishes

it has the form  $2b + w$  where  $w$  diminishes with  $v$ .

$$\therefore b + v/2b - \sqrt{(b^2 + v)} = v^2/(4b^2(2b + w)) = v^2/(8b^3 + 4b^2w)$$

This final expression goes to zero.

$$\therefore b + v/2b = \sqrt{(b^2 + v)} + (\text{goes to zero}) \text{ or limit of } \sqrt{(b^2 + v)} = b + v/2b$$

$$\text{Sym. } \sqrt{(b^2 - v)} \rightarrow b - v/2b$$

As "Sym." means "same method of argument" you should create this symmetric proof.

Now in our  $(-b - \sqrt{(b^2 - 4ac)})/2a$  we can substitute these limits for our  $a = 0$  to see what value the limit has as  $a \rightarrow \infty$ .

$$\text{Let } v = 4ac \therefore \sqrt{(b^2 - 4ac)} \text{ becomes } b - 4ac/2b$$

$$\frac{-b + b - 4ac/2b}{2a} = \frac{-4ac/2b}{2a} = \frac{-4ac}{4ab} \rightarrow \frac{-c}{b}$$

$$\frac{-b - b - 4ac/2b}{2a} = \frac{-2b + 2ac/b}{2a} \rightarrow \frac{-2b}{0}$$

Now  $bx + c$  is a line and if  $y = 0$  then  $-c/b$  is the  $x$ -intercept. The second value says that when  $x = -2b/0$  then  $y$  will equal zero again. Of course, this can't happen in a Euclidean sense. To me, it does not fit the idea of intersections at infinity for projective geometry. But I could be wrong or at least out of step with canonical thought. In any case, when you have a result like this **don't make any judgments**. Just let this value and the possible picture of intersection at infinity sit dormant in your memory and maybe someday, something will bring it back to life.

## Functions

Let's examine the idea of function of one variable which, if the variable is  $x$ , we denote as  $f(x)$ . Recall,  $f(x)$  is Leibniz and  $y$  is Newton for the same thing. Consider this form:

$$f(x) = c_0x^n + c_1x^{n-1} + c_2x^{n-2} + \dots + c_{n-1}x + c_n \quad [1]$$

If the number of terms are finite, this is a **common algebraical function**. If the terms are infinite, the infinite sum can be algebraical, as in

$$1/1-x = 1 + x + x^2 + x^3 + \dots$$

or, in a function like  $f(x) = a^x$ , the infinite sum can be a **transcendental** function. A function with an element in the form  $a^x$  is an **exponential fn** and a function with a logarithm like  $\log_{10}x$  is a **logarithmic fn**. Algebraic functions in form [1] are **polynomial** functions. Each term is a **monomial** and those are sometimes functions too. Given form [1], we consider the form of the coeffs:

1. If  $c_i \in \mathbf{Z}$  it is an **integral function**
2. If  $c_i \in \mathbf{Z}$  and  $c_0 = 1$  it is a **regular integral function**
3. If  $c_i \in \mathbf{Q}$  it is an **rational function**
4. If  $c_i \in \mathbf{R}$  it is a **real function**

[Here is a heads up for the serious autodidact. There are hundreds of free mathematical texts out there in PDF format and some, while still good, are pretty old. In older texts, **rational** can mean that **powers of  $x$**  are in **Z** and, in **irrational** functions, powers of  $x$  are in **Q**. In these texts, **integral** functions, rational and irrational, have  $x$  only in the numerator and **fractional** functions, rational and irrational, can have  $x$  in the denominator. In these,  $x + x^2/a$  would be integral and  $(a + x)/(bx + x^2)$  would be fractional. All of these designations have been abandoned. We use the four designations above.]

A function of one term of  $x$  is a monomial:  $x^3$ ,  $ax^2$ ,  $(bx)^{1/2}$  and one with two terms is a **binomial**:  $a + bx$ ,  $ax^2 + \sqrt{bx}$ . A term without an  $x$  is a **constant term**. You already know that the **degree** or **dimension** of a function is its highest power of  $x$ . We always arrange powers of  $x$  in ascending or descending order. Usually, we use the descending order of form [1]. But in transcendental functions and other infinite expressions, the form causes us to use ascending order:

$$f(x) = c_0 + c_1x + c_2x^2 + \dots + c_nx^n + \dots$$

When multiplying two polynomials the multiplication produces **subordinate products** some of which are combined into terms because the products have the same powers of  $x$ :

$$(x + 3)(x + 2) = x^2 + 2x + 3x + 6$$

and these four subordinate products combine into three terms:  $x^2 + 5x + 6$ . So regardless of ordering, there will always be two terms not made up of two or more subordinate products and they will have the highest and lowest powers of  $x$  in the result:

$$(ax^2 + bx^2 + cx^3)(px^4 + qx^5)$$

term with lowest power of  $x$ :  $apx^6$   
 term with highest power of  $x$ :  $cqx^8$

And you can see that no other subordinate product or term has  $x^5$  or  $x^8$ . Two have  $x^7$  and so on and the form of number will always work like this. We can use this idea in thinking about algebraic division. Consider:

$$\frac{8x^3 + 1}{2x + 1} \text{ For this to have a result with } \underline{(2x + 1)(\text{something})}$$

no remainder, we need:  $2x + 1$

And by the form of number wrt highest and lowest terms this something must take the form of:

$$\frac{(2x + 1)(cx^2 + bx + a)}{2x + 1}$$

The c must be 4 to get  $8x^3$  and a must be 1. So we are asking ourselves about:

$$\begin{aligned} 8x^3 + 1 &= (4x^2 + bx + 1)(2x + 1) \\ &= (2x + 1)(4x^2) + (2x + 1)(bx + 1) \\ \therefore 8x^3 + 1 - 8x^3 - 4x^2 &= (2x + 1)(bx + 1) \\ \therefore -4x^2 + 1 &= (2x + 1)(bx + 1) \end{aligned}$$

RHS has term  $2x \cdot bx$  which must be  $-4x^2 \therefore b$  must be  $-2$

So we have  $-4x^2 + 1 = (2x + 1)(-2x + 1)$

Recalling the form  $(a - b)(a + b) = a^2 - b^2$  this is  $1 - 4x^2 = (1 - 2x)(1 + 2x)$

And we now have  $a = 1, b = -2,$  and  $c = 4 \therefore$

$$\frac{8x^3 + 1}{2x + 1} = \frac{(2x + 1)(4x^2 - 2x + 1)}{2x + 1} = 4x^2 - 2x + 1$$

Earlier, we naively divided polynomials. And this worked because polynomials are subject to Euclid's Algorithm (Eu. 7.1) and therefore are an **integral domain**. Choice ordering of powers of  $x$  won't affect division but ordering must be consistent:

$\begin{array}{r} 2x + 1 \overline{) 8x^3 + 1} \\ \underline{8x^3 + 4x^2} \phantom{+ 1} \\ -4x^2 + 1 \phantom{+ 1} \\ \underline{-4x^2 - 2x} \phantom{+ 1} \\ 2x + 1 \\ \underline{2x + 1} \\ 0 \end{array}$	$\begin{array}{r} 1 + 2x \overline{) 1 + 8x^3} \\ \underline{1 + 2x} \phantom{+ 8x^3} \\ -2x + 8x^3 \\ \underline{-2x - 4x^2} \phantom{+ 8x^3} \\ 4x^2 + 8x^3 \\ \underline{4x^2 + 8x^3} \\ 0 \end{array}$
--	--

If  $P$  and  $Q$  are rational fns, you can see that  $P + Q, P - Q,$  and  $PQ$  must also be rational fns. Under what conditions is  $P \div Q$  not a rational fn? Or is it always a rational fn?

Division of fns leads to factors of fns. Every polynomial  $P$  which divides polynomial  $Q$  without remainder is a factor of  $Q$ . In Arithmetic's Division section, we saw synthetic division used with the Remainder Theorem. These remain important. The simplest factors of  $Q$  are binomials which reveal the roots of  $Q$  or those values of  $x$  where  $f(x) = 0$ .

Let's look into polynomial (poly) division:

1. No poly can have a factor of higher degree than itself.
  2. If poly  $m^\circ$  and any factor is  $p^\circ,$  the remainder is  $(m - p)^\circ$
- $$\begin{aligned} x^4 - 1 &= (x - 1)(x^3 + x^2 + x + 1) && 1^\circ + 3^\circ \\ &= (x^2 - 1)(x^2 + 1) && 2^\circ + 2^\circ \\ &= (x - 1)(x + 1)(x^2 + 1) && 1^\circ + 1^\circ + 2^\circ \end{aligned}$$





New ideas from after De Morgan's time have become fundamental to our study of functions.

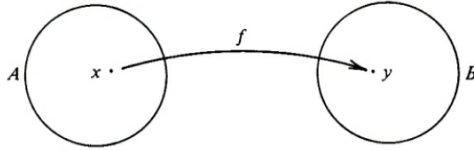

**Def.** Given two sets, A and B, a **function**  $f(x): A \rightarrow B$  assigns every  $x \in A$  to a **unique**  $y \in B$ . Here  $y$  is the **image of  $x$  under  $f(x)$** . In advanced mathematics, A and B are often separate. But in most common cases, they are the same:

$f(x) = x^3$  maps  $\mathbf{R} \rightarrow \mathbf{R}$

$f(x) = x^2$  maps  $\mathbf{R} \rightarrow \mathbf{R}^+$  or  $[0, \infty)$

$f(x) = 3x + 1$  maps  $\mathbf{Z} \rightarrow \mathbf{Z}$

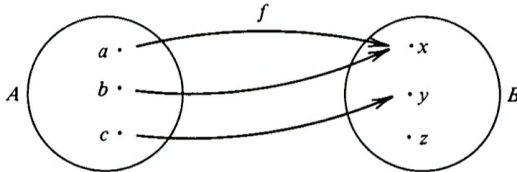

A is the **domain** of the function. But  $f(x)$  may not cover all of B. The part of B that  $f(x)$  does cover, all or some, is the **range** of the function. Here z is not in the range of  $f(x)$ .

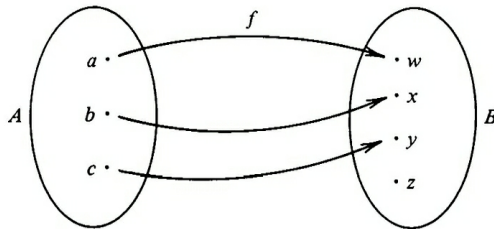

**Def.**  $f(x): A \rightarrow B$  is **injective** or **1-1** if each  $y \in B$  in the range of  $f(x)$  is the image of only one  $x \in A$ . Another way to say this: F is an injection if and only if  $f(x_1) = f(x_2)$  implies  $x_1 = x_2$ . Here  $f(x)$  is an injection even though z is not in its image.

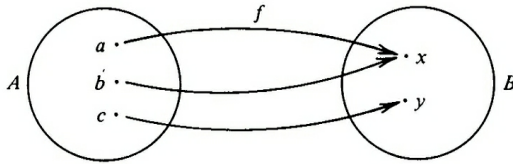

**Def.**  $f(x): A \rightarrow B$  is **surjective** or **onto** if every  $y \in B$  is the image of one or more  $x \in A$  under  $f(x)$ . So a  $y \in B$  can be the image of more than one  $x \in A$  under  $f(x)$ . But, to be a function, no  $x \in A$  can have more than one image in B.

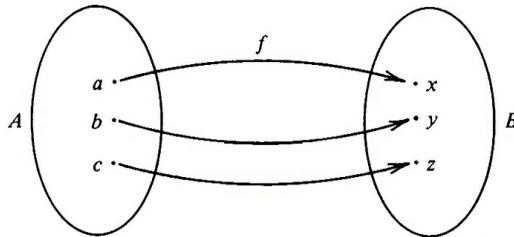

**Def.** A function  $f(x): A \rightarrow B$  is **bijective** or **1-1 and onto** if it is both injective and surjective.

We can extend this idea of functions to composite functions. Here we have  $f(x): A \rightarrow B$  and  $g(y): B \rightarrow C$ . The above definitions apply to everything here. If we use  $f(x)$  and then use  $g(y)$  on the result of  $f(x)$ , we have a **compound** or **composite** function. The composite symbol below " $\bullet$ " is often shown as a circle about the same size in the same position.

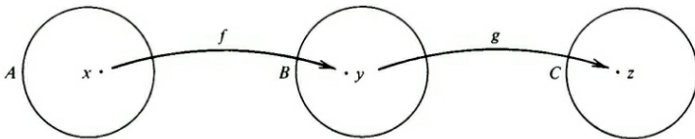

**Def.** Given  $f(x): A \rightarrow B$  and  $g(y): B \rightarrow C$ , the **compound** or **composite** function  $g \bullet f: A \rightarrow C$  is defined as  $g(f(x))$  for  $\forall x \in A$ .

You can see that order is important here:

$$\begin{aligned} f: \mathbf{R} \rightarrow \mathbf{R} \quad f(x) &= 2x \\ g: \mathbf{R} \rightarrow \mathbf{R} \quad f(x) &= x + 1 \\ f \bullet g &= f(g(x)) = 2(x + 1) \\ g \bullet f &= g(f(x)) = 2x + 1 \end{aligned}$$

You should be able to easily prove the following theorems by yourself:

Given  $f: A \rightarrow B$  and  $g: B \rightarrow C$

If  $f$  and  $g$  are onto, then  $g \circ f$  is onto.

If  $f$  and  $g$  are injections, then  $g \circ f$  is an injection.

If  $f$  and  $g$  are bijective, then  $g \circ f$  is a bijection.

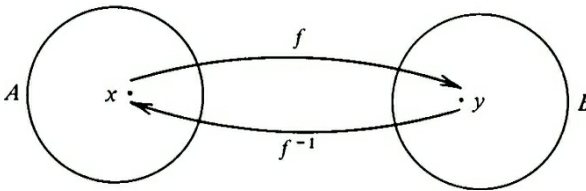

One more related idea:  $f: A \rightarrow B$  may or may not have an inverse function  $f^{-1}$  that takes every  $y$  in the range of  $f$  in  $B$  back to its original  $x$  in  $A$ . If we have an **f-inverse** or  **$f^{-1}$**  then:

$$x = f^{-1}(y) \Leftrightarrow y = f(x) \quad \forall y \in \text{range } f$$

So if  $f(x) = 2x$  then  $f^{-1}(y) = y/2$ . If zero is not in the domain, then if  $f(x) = 1/x$ , we have an inverse  $f^{-1}(y) = 1/y$ . But if  $f(x) = |x|$  we cannot have an inverse because it would have to make  $y$  and  $-y$  to  $x$  and would therefore no longer be a function that maps each element in the domain to a unique element in the range.

In many cases, the domain is infinite. If  $f: \mathbf{R} \rightarrow \mathbf{R}$  and  $f$  is 1-1 and onto then its range is all of  $\mathbf{R}$  and being a bijection there is an  $f^{-1}$ . But if  $f: \mathbf{Z} \rightarrow \mathbf{R}$  or  $f: \mathbf{N} \rightarrow \mathbf{R}$  or if, for some finite set  $A$ , we define an  $f: A \rightarrow \mathbf{R}$ , then  $f$  could be 1-1 and onto its range  $B$  which would be a subset of  $\mathbf{R}$  or  $B \subset \mathbf{R}$  and we could still have an  $f^{-1}$ . Some textbooks muddle this up. But if  $f$  is a bijection or 1-1 and onto its range, there is **always** an  $f^{-1}$ .

Decide whether the following are injective, surjective, or bijective and give their range. To show that something is not, say, injective, you only have to give one concrete **counterexample** which shows, in this case, that two  $x$ 's go to one  $y$ .

$$f(x) = 2x$$

$$f(x) = x^3 + 1$$

$$f(x) = 3x + 4$$

$$f(x) = x^2$$

$$f(x) = x^3 - 3x$$

$$f(x) = x, \text{ if } x \in \mathbf{Q}, \text{ or } 2x, \text{ if } x \text{ irrational}$$

We can expand our ideas of function notation to think about functions more generally. You've seen how we use  $f(x)$  followed by its definition:

$$f(x) = ax^2 + bx + c$$

And then we can speak of that particular  $f(x)$  as shorthand for the longer definition until we redefine it. We use  $f, g, h$  on this level of abstraction. We also use  $F, \varphi, \psi$  and other symbols, usually Greek letters, at a higher level. Let's look at this higher level. Here parens are optional and used for clarity only,  $\varphi x$  is simply  $\varphi(x)$ .

$$\varphi x = x^a \quad \therefore \varphi(1+x) = (1+x)^a$$

This leads to a useful arithmetic:

$$\text{Let } \phi x = ax \therefore \phi bx = abx = b \cdot \phi x \text{ or } \phi bx = b\phi x$$

You can see how this arithmetic creates a level of abstraction if you will work out the following equalities.

If $\phi x = x^a$	then	$\phi x \cdot \phi y = \phi(xy)$
If $\phi x = a^x$	then	$\phi x \cdot \phi y = \phi(x + y)$
If $\phi x = ax + b$	then	$(\phi x - \phi y) / (\phi x - \phi z) = (x - y) / (x - z)$
If $\phi x = ax$	then	$\phi x + \phi y = \phi(x + y)$

We can work backwards in this arithmetic.

If  $\phi(xy) = x\phi y$  this is true if  $y = 1$ .  
 $\therefore \phi x = x\phi(1)$   
 But  $\phi(1)$  is a constant. Call it  $c$ .  
 Now we determine its value.  
 $\phi x = cx \therefore \phi xy = cxy$  and  $x\phi y = x \cdot cy = cxy$   
 $\therefore \phi(xy) = x\phi y$  for  $\forall c$   
 $\phi x = cx$  and  $\phi(1) = c$   
 $\therefore \phi x = cx$  for any  $c$

I would not go on from here until that last bit is solid in your mind. Don't let the finite mind simply slide over it. You will need what you learn here again and again. And don't make it harder than it is.

So if  $\phi(xy) = (\phi x)^y$  then let  $x = 1$ .  
 $\therefore \phi y = (\phi(1))^y = c^y \therefore \phi x = c^x$   
 And we check this by showing  
 $\phi(xy) = c^{xy} = (c^x)^y = (\phi x)^y$  as we began.

Let us prove that this works in general by showing that it leads to a unique result of:

**Theorem**  $\phi(xy) = (\phi x)^y \Leftrightarrow \phi(x) = c^x$

**Proof**

Let  $\phi x$  for  $\forall x, y$  be  $\phi x \cdot \phi y = \phi(x + y)$  [A]  
 $y = a + b \therefore \phi x \cdot \phi(a + b) = \phi(x + a + b) = \phi x \cdot \phi a \cdot \phi b$  (by [A])  
 $a = c + d \therefore \phi x \cdot \phi(c + d) \cdot \phi b = \phi(x + c + b + d) = \phi x \cdot \phi c \cdot \phi b \cdot \phi d$   
 $\therefore$  For  $a_i [i := 1-n] \phi a_1 \cdot \phi a_2 \cdots \phi a_{n-1} \cdot \phi a_n = \phi(a_1 + a_2 + \cdots + a_{n-1} + a_n)$   
 Let  $a_i = a_j$  for  $\forall i, j$   
 $\therefore (\phi a)^n = \phi(a + a + \cdots [n \text{ times } a] \cdots + a + a)$   
 $\therefore (\phi a)^n = \phi(na) \forall n \in \mathbf{N}$   
 $\therefore (\phi b)^m = \phi(mb)$   
 Let  $mb = na \therefore (\phi b)^m = (\phi a)^n \therefore \phi b = (\phi a)^{n/m}$   
 But  $b = n/m \cdot a \therefore \phi(n/m \cdot a) = (\phi a)^{n/m}$   
 $\therefore \phi(pa) = (\phi a)^p \forall p \in \mathbf{Q}$   
 In [A], let  $x = y = 0 \therefore x + y = 0$   
 Let  $\phi(0) = c \therefore c \cdot c = c \therefore c = 1$   
 Let  $y = -x \therefore x + y = 0 \therefore \phi x \cdot \phi(-x) = 1 \therefore \phi(-x) = 1/\phi x$   
 $\therefore \phi(-pa) = 1/(\phi(pa)) = 1/((\phi a)^p) = (\phi a)^{-p}$   
 $\therefore$  if  $a = 1$  then  $\phi p = c^p \therefore \phi x = c^x$  for  $\forall x$

This is the most difficult proof that we have done. It shows what is possible in proofs, especially how, by making choices of internal values, we can make the form reveal itself. Go back and determine where these choices were made. Then consider what must be known in order to make each choice. Then consider the choices as a whole and how they drive the proof to the final form of  $c^x$ .

This is an important proof and will be used two or three more times in this text to establish that something has this form. I'm not saying you should memorize it. But you should make sure you understand it. And then you should keep it in mind. Many important ideas have this form and if you can remember that  $\varphi(xy) = (\varphi x)^y \Leftrightarrow \varphi(x) = c^x$  then seeing one side of this in the form you are working with will establish the existence of the other form. And you can then bring more power and more tools to your work.

## Series

We've seen that if  $x \in (0,1)$ :

$$1 + x + x^2 + x^3 + \dots \quad [1]$$

gets closer and closer to  $1/(1-x)$  as we add more terms but that it never exceeds this **limit**. This is an **infinite series** and  $1/(1-x)$  is its **sum**.

**Def.** The **sum of an infinite series** is the limit it approaches as the terms are added. If a limit exists, the series is **convergent**; if no limit exists, the series is **divergent**.

These are divergent:

$$\begin{array}{ll} 1 + 1 + 1 + \dots + 1 + \dots & 1 + 2 + 3 + \dots + n + \dots \\ 1 + 2 + 4 + \dots + 2^n + \dots & 1 + 1/2 + 1/3 + \dots + 1/n + \dots \end{array}$$

We have to reason upon the relation of the terms and consider the form of its **general term** in order to find a limit. In [1],  $x^n$  is the general term and you can see the general term indicated in the divergent series above. If there is no law of the relation of terms, we cannot conceive of a general term or consider a limit.

The following series have laws. What are they? Note that a law can come into effect at any point in the series. But then it must continue to apply.

$$\begin{array}{l} 7 \ 16 \ 22 \ 26 \ 32 \ 36 \ 42 \ \dots \\ 5 \ 10 \ 9 \ 10 \ 9 \ 10 \ 9 \ \dots \\ 5 \ 10 \ 11 \ 15 \ 21 \ 30 \ 39 \ 43 \ 52 \ 61 \ 70 \ \dots \\ 79 \ 85 \ 94 \ 103 \ 109 \ 109 \ 109 \ \dots \end{array}$$

Consider this series:

$$43 \ 47 \ 53 \ 61 \ 71 \ 83 \ 97 \ 113 \ \dots$$

These are all prime numbers. But we must find and consider the law, not its incidental results. Here  $a_n = (n \cdot (n+1)) + 41$ . And this term results in primes up to the 39th term which is  $39 \cdot 40 + 41 = 1601$ . But the next term is  $40 \cdot 41 + 41 = 41^2$  which is not prime.

**Def.** The **general term** of an infinite series is the algebraical expression of the  $n$ th term which embodies the law of the series.

<u>Series</u>	<u>Nth Term</u>
1 2 3 4 ...	$n$
1 4 9 16 ...	$n^2$
1 x x <sup>2</sup> x <sup>3</sup> ...	$x^{n-1}$
1 x/2 x <sup>2</sup> /3 x <sup>3</sup> /4 ...	$x^{n-1}/n$
1 x x <sup>2</sup> /2 x <sup>3</sup> /6 ...	$x^{n-1}/(n-1)!$

In this last series, the first term is not under the law. One of the tools we have of judging the convergence of an infinite series is the ratio of successive terms. This is what we are showing in this next theorem.

**Theorem** The infinite sum  $a + b + c + d + e + \dots$  is the same as

$$a(1 + b/a + cb/ba + dcb/cba + edcb/dcba + \dots)$$

This is just algebra. Prove it to yourself if you can't just see the equality. Let the ratio of each term to the preceding term be the capitalized numerator:

$$b/a = B \quad c/b = C \quad d/c = D \quad e/d = E$$

Then  $a + b + c + d + e + \dots = a(1 + B + CB + DCB + EDCB) \quad [2]$

If every ratio  $(B, C, D, \dots)$  is less than some quantity  $P$  then

$$\begin{aligned} a(1 + B) &< a(1 + P) \\ a(1 + B + CB) &< a(1 + P + PP) \quad \text{and so on} \end{aligned}$$

Then the sum of [2] is less than  $a(1 + P + P^2 + P^3 + \dots)$

So if  $P < 1$ , we know the limit if  $a/(1-P)$  because its larger factor has the form of [1] which proves the next theorem:

**Theorem** A series is always convergent when the ratio of any term to the preceding term is less than some quantity which itself is less than unity.

This can happen after any finite number of terms. If the first 50 terms sum to  $10^4$  but the remaining terms have a limit (or sum) of 50, the series has a finite limit of 10050. Here is an important series of this kind:

$$1 + 1 + 1/2! + 1/3! + 1/4! + \dots$$

If you will use your calculator to sum the first ten terms of this series, you can determine a decent approximation of Euler's number  $e$ .

**Theorem** The series  $a + b + c + \dots$  is convergent if:

- 1) the terms monotonically decrease after a given term ( or  $a > b > c > \dots$ ) and
- 2) some term in the series is less than any chosen fraction.

**Proof**

The series  $(a-b) + (b-c) + (c-d) + \dots$  is a series of decreasing terms with a limit of  $a$  (just regroup the parens). So a series made of alternating terms of this series  $(a-b) + (c-d) + \dots$  has a limit less than  $a$ . And these alternate terms are our series in the theorem. ■

**Example**  $1 - 1/2 + 1/3 - 1/4 + \dots$  converges to some limit  $< 1$ .

**Theorem** If any quantity  $P$  is greater than any one of the series of ratios above:

$b/a, c/b, d/c, \dots$  then the series  $a + bx + cx^2 + dx^3 + \dots$  is convergent when  $x < 1/P$ .

**Proof**

With the series  $a(1 + (b/a) \cdot x + (cb/ba) \cdot x^2 + (dcb/cba) \cdot x^3 + \dots)$  if  $P$  is greater than any of the ratios  $b/a, c/b, \dots$  then this next series is bigger

$$a(1 + Px + P^2x^2 + P^3x^3 + \dots) = a(1 + Px + (Px)^2 + (Px)^3 + \dots)$$

And we know this last series converges if  $Px < 1$  or  $x < 1/P$ . So the original smaller series converges. ■

**Example** Consider  $1 + 2x + 3x^2 + 4x^3 + \dots$  with ratios  $2/1, 3/2, 4/3, \dots$ . Then 2 is greater than any of these after the first. So if  $x < 1/2$ , then this series converges beginning with the second term.



**Example** Consider  $1 + x + x^2/2! + x^3/3! + \dots$  with ratios  $1, 1/2, 1/3, 1/4, \dots$ . The ratios monotonically diminish. So for any fraction  $m$ , no matter how small, a term comes where  $1/m$  is smaller than that ratio and all remaining ratios. So  $x < 1/(1/m) = m$  is any value no matter how great. So this series converges for any  $x$ .

**Theorem** If  $P$  is less than any of the ratios  $b/a, c/b, \dots$  then  $a + bx + cx^2 + \dots$  diverges for any  $x > 1/P$

**Proof**

Follows from last theorem.

From this point we consider **only** convergent series with positive terms unless otherwise defined.

**Theorem** Every series of the form  $a + bx + cx^2 + \dots$  has the property that, if  $x$  is small enough, then any one term can contain the sum of all the following terms.

**Proof**

Then for some  $x$ , some term ( $cx^2$ ) can be any multiple ( $10^4$ ) of the remaining terms ( $dx^3 + ex^4 + \dots$ ) Let  $x_1$  be the greatest value that makes the remaining terms convergent and let the sum of this partial series be  $S$ . Then any  $x < x_1$ ,  $d + ex + \dots < S$ . So  $cx^2$  contains the remaining sum as follows:

$$\frac{cx^2}{dx^3 + ex^4 + \dots} = \frac{c}{dx + ex^2 + \dots} = \frac{c}{x(d + ex + \dots)}$$

$$\text{So for } x < x_1, \frac{c}{xS} < \frac{c}{x(d + ex + \dots)} = \frac{cx^2}{dx^3 + ex^4 + \dots}$$

$S$  and  $c$  are fixed quantities. So  $x$  can be chosen so that  $c/xS$  is larger than  $10^4$  which makes  $cx^2/(\text{remainder of series})$  even greater. This is sym. true of any term and any multiple. ■

**Example** Required:  $x$  in  $1 + 2x + 3x^2 + \dots: 4x^3$  contains  $10^3 \cdot (\text{sum of remaining terms})$

The remainder is  $5x^4(1 + 6/5x + 7/6 \cdot 6/5x^2 + \dots)$  [A]

$6/5$  is greater than any following ratio. So this next series is greater than [A]

$5x^4(1 + 6/5x + 6/5 \cdot 6/5x^2 + \dots) = 1/(1 - (6/5)x)$  [B]

So we need  $x: 4x^3 > 10^3 \cdot [B]$  or  $1 - 6/5x > 1250x$

or even more so if  $1 - 2x > 1250x$

or  $1 > 1252x$  or  $x < 1/1252$

So if  $x < 1/1252$  then  $4x^3 > 10^3 \cdot [B]$  and even greater than  $10^3 \cdot [A]$

Let's look at how an infinite series can be expressed as a finite algebraic relation  $P$ . Here's one we already know:

1)

$$P = 1 + x + x^2 + x^3 + \dots$$

$$1 + x + x^2 + \dots = 1 + x(1 + x + x^2 + \dots)$$

$$\therefore P = 1 + xP$$

$$\therefore P = 1/(1-x) \text{ by simply solving for } P.$$

2)

$$P = 1 + 2x + 3x^2 + 4x^3 + \dots$$

$$(P-1)/x = 2 + 3x + 4x^2 + 5x^3 + \dots$$

$$\therefore (P-1)/x - P = 1 + x + x^2 + \dots = 1/(1-x)$$

$$\therefore P(1/x - 1) = 1/(1-x) + 1/x = 1/x \cdot 1/(1-x) \therefore P = 1/(1-x)^2$$

Make sure you can work that out algebraically.

3)

$$\begin{aligned}
 P &= 1 + 3x + 5x^2 + 7x^3 + \dots \\
 (P-1)/x &= 3 + 5x + 7x^2 + \dots \\
 \therefore (P-1)/x - P &= 2 + 2x + 2x^2 + \dots = 2/(1-x) \\
 \therefore P &= (1+x)/(1-x)^2
 \end{aligned}$$

Use this method to show that  $1 + 4x + 9x^2 + 16x^3 + \dots = (1+x)/(1-x)^3$ . We can use this method to find the sum of a finite number of terms.

$$\begin{aligned}
 P &= 1 + 2x + 3x^2 + \dots + (n-1)x^{n-2} + nx^{n-1} \\
 (P-1)/x &= 2 + 3x + 4x^2 + \dots + nx^{n-2} \\
 (P-1)/x - P &= 1 + x + x^2 + \dots + x^{n-2} - nx^{n-1} \\
 &= (1-x^{n-1})/(1-x) - nx^{n-1} = (1 - (n+1)x^{n-1} + nx^n)/(1-x) \\
 \therefore P &= (nx^{n+1} - (n+1)x^n + 1)/(1-x)^2
 \end{aligned}$$

You should be able to work that last one out algebraically if you will recall that  $x^n - a^n$  is divy by  $x - a$  for all  $n \in \mathbb{N}$  and remember that this can be  $a^n - x^n$  divy by  $a - x$  and let  $a = 1$  and  $x^n$  be  $x^{n-1}$ . Or do you need a hint? One more theorem:

**Theorem** If the two series  $a_0 + a_1x + a_2x^2 + \dots$ ,  $b_0 + b_1x + b_2x^2 + \dots$  are equal for every finite  $x$  then  $a_i = b_i$  for  $\forall i$  and the series are the same.

**Proof**

This theorem sounds trivial but it is not. We will show it is not trivial and also show how to take our  $P$  from above and develop it in a series of powers of its  $x$ . So given the next LHS we determine its RHS:

$$\begin{aligned}
 (1+x)/(1-x)^2 &= a_0 + a_1x + a_2x^2 + a_3x^3 + \dots \\
 \text{Multiply both sides by } (1-x)^2 \text{ or } 1 - 2x + x^2 & \\
 1 + x &= a_0 + a_1x + a_2x^2 + a_3x^3 + \dots \\
 &\quad - 2a_0x - 2a_1x^2 - 2a_2x^3 - 2a_3x^4 + \dots \\
 &\quad \quad a_0x^2 + a_1x^3 + a_2x^4 + a_3x^5 + \dots \\
 &= a_0 + (a_1 - 2a_0)x + (a_2 - 2a_1 + a_0)x^2 + \dots
 \end{aligned}$$

Both sides are equal. So we use the last theorem to show:

$$\begin{aligned}
 a_0 &= 1 & a_1 - 2a_0 &= 1 \therefore a_1 = 3 \\
 a_2 - 2a_1 + a_0 &= 0 & \therefore a_2 &= 5 \\
 a_3 - 2a_2 + a_1 &= 0 & \therefore a_3 &= 7 \text{ and so on} \\
 \therefore \text{our required series is } &1 + 3x + 5x^2 + 7x^3 + \dots
 \end{aligned}$$

If we develop  $1/(1+x^2)$  the same way:  $1/(1+x^2) = a_0 + a_1x + a_2x^2 + a_3x^3 + \dots$

And our theorem gives us:

$$\begin{aligned}
 a_0 &= 1 & a_2 + a_0 &= 0 \therefore a_2 = -1 & a_4 + a_2 &= 0 \therefore a_4 = 1 \\
 a_1 &= 0 & a_3 + a_1 &= 0 \therefore a_3 = 0 & a_5 + a_3 &= 0 \therefore a_5 = 0
 \end{aligned}$$

and the series is  $1 - x^2 + x^4 - x^6 + \dots$  as you can work out for yourself.

If this process of equating  $a_i$  can't be used, then the expression can't be developed into an infinite series. A few remarks on infinite series. Let  $x$  first be positive, then be reduced to zero, then be negative. The following fns values will then take the following signs:

sign of x	+	0	-
$1/x$	+	$\infty$	-
$x^3$	+	0	-
$1/x^3$	+	$\infty$	-
$x^2$	+	0	+
$1/x^2$	+	$\infty$	+

If when  $x$  changes from  $a$  to  $b$ , passing through all intermediate values, the sign of  $f(x)$  changes from positive to negative or vice versa, then the point at which the change takes place is either infinite or nothing but the converse is not true, that a function always changes its sign when its value becomes nothing or infinite. Consider:

$$\begin{aligned} 1/(1-x) &= 1 + x + x^2 + \dots \\ 2 &= 1 + 1/2 + 1/4 + \dots \\ 1/0 &= 1 + 1 + 1 + \dots \\ -1/2 &= 1 + 2 + 4 + \dots \end{aligned}$$

That last one is not true (you noticed, right?). *When an equality specified is purely algebraical, we are not at liberty to compare magnitudes by any arithmetical comparison, if infinite series are in question.* A more modern way to say this is that infinite series are only true when they converge. And convergence often requires limitations to be placed on the value of  $x$ .

*With respect to divergent series, we admit no results of comparison except those which are derived from their equivalent finite algebraical expression.* A simple example of this is the  $1/0$  or  $\infty$  series above. When Euler first discovered the usages of infinite series, he did not distinguish between convergence and divergence. And so for him, our

$$1/(1+x) = 1 - x + x^2 - x^3 + \dots$$

proved that  $1/2 = 1 - 1 + 1 - 1 + \dots$ . This is another case, as with zero, the negative numbers and the idea of a limit, where mathematics took a century or so to sort things out. This elevation of a new idea to a correct and consistent idea separated the gold from the dross in all the work done with that idea in its transition period and clarified the understanding of the mathematicians involved.

## The Binomial Theorem

I could lay out the algorithm of the Binomial Theorem's expansion of  $(x + a)^n$  and we could treat it like our baby arithmetic algebra. The arithmetic of algebra is always and forever simply arithmetic. But algebra is the study of the form of number. Let's come to an understanding of the form of Newton's Binomial Theorem or the expansion of any binomial to any exponent.

The Binomial Theorem is the expansion, finite or infinite, of any binomial  $(a + b)^n$  where  $n$  is any exponent: positive, negative, or fractional. We can reduce  $(a + b)^n$  to  $(1 + x)^n$  like this:

$$a + b = a(1 + b/a) \therefore (a + b)^n = a^n(1 + b/a)^n$$

Let  $x = b/a$  and lose the constant, which we can restore if necessary:  $(1 + x)^n$

As with previous series, we want (from our earlier non-trivial theorem)

$$(1 + x)^n = a_0 + a_1x + a_2x^2 + \dots$$

and we must work out the values of each  $a_i$ .

**Lemma** (a lemma is a subsidiary proof to be used in some larger proof which follows it)

For any  $n$ ,  $(a^n - b^n)/(a - b)$  the limit as  $b \rightarrow a$  is  $na^{n-1}$ . Note that if  $a = b$  it becomes  $0/0$  but it will have a **limit**:  $na^{n-1}$ .

**Proof**

$$\text{If } n \in \mathbf{N}, (a^n - b^n)/(a - b) = a^{n-1} + a^{n-2}b + a^{n-3}b^2 + \dots + ab^{n-2} + b^{n-1}$$

$$\begin{aligned} \text{As } a \rightarrow b: a^{n-1} + a^{n-2}a + a^{n-3}a^2 + \dots + aa^{n-2} + a^{n-1} \\ = a^{n-1} + a^{n-1} + a^{n-1} + \dots + a^{n-1} + a^{n-1} = na^{n-1} \end{aligned}$$

$$\begin{aligned} \text{If } n = p/q \in \mathbf{Q}, (a^n - b^n)/(a - b) &= (a^{p/q} - b^{p/q})/(a - b) \\ &= \frac{(a^{1/q})^p - (b^{1/q})^p}{(a^{1/q})^q - (b^{1/q})^q} \text{ Let } a^{1/q} = a_1 \text{ } b^{1/q} = b_1 \text{ then } \frac{a_1^p - b_1^p}{a_1^q - b_1^q} = \frac{(a_1^p - b_1^p)}{(a_1^q - b_1^q)} \cdot \frac{1}{(a_1 - b_1)} \end{aligned}$$

We already proved that as  $b_1 \rightarrow a_1$  this goes to:

$$\frac{pa_1^{p-1}}{qa_1^{q-1}} = p/q \cdot a_1^{p-q} = p/q \cdot (a^{1/q})^{p-q} = p/q \cdot a^{p/q-1} = na^{n-1}$$

If  $n < 0$  then  $n = -p$

$$\frac{a^n - b^n}{a - b} = \frac{a^{-p} - b^{-p}}{a - b} = \frac{1/a^p - 1/b^p}{a - b} = \frac{1}{a - b} \cdot \frac{b^p - a^p}{a^p b^p} = -\frac{1}{a - b} \cdot \frac{a^p - b^p}{a^p b^p}$$

$$\text{As } b \rightarrow a \text{ this is } -a^{-2p} \cdot pa^{p-1} = -pa^{p-1} = na^{n-1} \blacksquare$$

This lemma is another study in the manipulation of form which allows De Morgan to show all three cases identical.

Back to finding our  $a_i$ :

[Cont'd next page.]

$$A = (1+x)^n = a_0 + a_1x + a_2x^2 + \dots$$

$$B = (1+y)^n = a_0 + a_1y + a_2y^2 + \dots$$

$$A-B = a_1(x-y) + a_2(x^2-y^2) + \dots$$

Divide both sides by  $x-y$ , LHS in its form of  $(1+x) - (1-y)$

$$\frac{(1+x)^n - (1+y)^n}{(1+x) - (1+y)} = a_1 + a_2 \frac{x^2 - y^2}{x-y} + a_3 \frac{x^3 - y^3}{x-y} + \dots$$

By lemma, as  $y \rightarrow x$  both sides are therefore

$$n(1+x)^{n-1} = a_1 + 2a_2x + 3a_3x^2 + \dots$$

Multiply both sides by  $(1+x)$

$$\therefore n(1+x)^n = a_1 + 2a_2x + 3a_3x^2 + 4a_4x^3 + \dots \\ + a_1x + 2a_2x^2 + 3a_3x^3 + \dots$$

But by our original assumption of form:

$$n(1+x)^n = na_0 + na_1x + na_2x^2 + \dots$$

$$\therefore a_1 = na_0 \quad 2a_2 + a_1 = na_1 \quad \text{or} \quad a_2 = (n-1)/2 \cdot a_1 = n \cdot (n-1)/2 \cdot a_0$$

By the same algebra:

$$3a_3 + 2a_2 = na_2 \quad \therefore a_3 = n \cdot (n-1)/2 \cdot (n-2)/3 \cdot a_0$$

$$4a_4 + 3a_3 = na_3 \quad \therefore a_4 = n \cdot (n-1)/2 \cdot (n-2)/3 \cdot (n-3)/4 \cdot a_0$$

So we have this form with  $a_0$  undetermined:

$$(1+x)^n = a_0(1 + nx + n \cdot (n-1)/2 \cdot x^2 + n \cdot (n-1)/2 \cdot (n-2)/3 \cdot x^3 + \dots)$$

Before we go on, consider convergence. Here, ratios of terms are:

$$nx, (n-1)/2 \cdot x, (n-2)/3 \cdot x, \dots \therefore \text{general term } ((p+2)\text{term})/((p+1)\text{term}) = (n-p)/(p+1) \cdot x$$

If  $p \in \mathbf{N}$ , series is finite because  $(n-p)/(p+1)$  becomes 0 at the  $(n+2)$ th terms and stays there. What if  $n$  is fractional or negative? When  $p > n$ ,  $(n-p)/(p+1)x$  is always negative so terms alternate sign, since if the ratio is negative, the terms must alternate sign. A series of alternating-sign terms is convergent if the corresponding series of all positive terms converges. If all terms are positive:

$$(p-n)/(p+1)x = px/(1+p) - nx/(1+p) = x/(1+1/p) - nx/(1+1/p)$$

As  $p \rightarrow \infty$ , 1st term goes to  $x$ , 2d term goes to 0,  $\therefore$  if  $x < 1$ , at some point the ratio will be less than unity and will approach a limit. So both the series of positive and the series of alternating sign are convergent.

This being the case, we can, as before, make  $x = 0 \therefore (1)^n = a_0$  or  $a_0 = 1$  for all  $n$ , either integer or fraction. When  $n$  is fractional,  $(1)^n = (1)^{p/q} = a_0$  and here we are choosing 1 as the  $q$ th root of 1. Later, we will see that 1, or unity, has  $n$  roots of unity for every  $n$ . If  $n=3$ , the roots are 1,  $-1/2 + i\sqrt{3}/2$ ,  $-1/2 - i\sqrt{3}/2$  where  $i = \sqrt{-1}$ . And we have seen that if  $n$  is fractional, then only  $x < 1$  leads to convergence. (Just so we're solid here,  $x < 1$  means  $x$  is on the open interval  $(0,1)$ .)

De Morgan's proof of the Binomial Theorem which follows is a good example of proof by induction. To do this, we must:

- 1) Show true for  $n = 1$  (or if this is trivial, show for  $n =$  first non-trivial  $n$ )
- 2) Assume true for  $n = n$
- 3) Use algebra to bring both sides to  $n+1$  (You can assume  $n-1$  and move to  $n$ , if easier.)
- 4) Bring the result back to the general form of what you are proving.

So you show the first term is true. Then take any term and turn it into the next. This gives you  $n=2$  from  $n=1$ ,  $n=3$  from  $n=2$ , and so on by implication. Study De Morgan's proof to see how this works. He does it in an interesting way.

### Proof of Binomial Theorem.

Suppose the theorem is true for any one whole number, say  $m$ .

Then ( $a_0$  being 1):  $(1+x)^m = 1 + mx + m \cdot (m-1)/2 \cdot x^2 + m \cdot (m-1)/2 \cdot (m-2)/3 \cdot x^3 + \dots$

Multiply both sides by  $(1+x)$ :

$$\begin{aligned} (1+x)^{m+1} &= 1 + mx + m \cdot (m-1)/2 \cdot x^2 + m \cdot (m-1)/2 \cdot (m-2)/3 \cdot x^3 + \dots \\ &\quad + x + \quad \quad \quad m \cdot x^2 + \quad \quad \quad m \cdot (m-1)/2 \cdot x^3 + \dots \\ &= 1 + (m+1)x + (m \cdot (m-1)/2 + m)x^2 + (m \cdot (m-1)/2 \cdot (m-2)/3)x^3 + \dots \end{aligned}$$

But  $m \cdot (m-1)/2 + m = m \cdot (m-1)/2 + 1 = m \cdot (m+1)/2 = (m+1) \cdot m/2$

And  $m \cdot (m-1)/2 + m \cdot (m-1)/2 = m \cdot (m-1)/2 \cdot ((m-2)/3 + 1) = (m+1) \cdot m/2 \cdot (m-1)/3$

$$\therefore (1+x)^{m+1} = 1 + (m+1)x + (m+1) \cdot m/2 \cdot x^2 + (m+1) \cdot m/2 \cdot (m-1)/3 \cdot x^3 + \dots$$

which, if we write  $n$  for  $m+1$  and  $n-1$  for  $m$ , becomes the same series, or follows the same law as:

$$(1+x)^n = 1 + nx + n \cdot (n-1)/2 \cdot x^2 + n \cdot (n-1)/2 \cdot (n-2)/3 \cdot x^3 + \dots$$

Therefore, if the expression be true for any one whole value of  $n$ , it is true for the next. But it is true when  $n=1$  for:

$$(1+x)^1 = 1 + 1x + 1 \cdot (1-1)/2 \cdot x^2 + 1 \cdot (1-1)/2 \cdot (1-2)/3 \cdot x^3 + \dots$$

$\therefore$  it is true when  $n=2$ . But it is therefore true when  $n=3$  and so on, *ad infinitum*. ■

You can see that he has covered, in his own way, the four steps of proof by induction. You could try your hand at proof by induction by proving the sum of an A.P. or G.P.

Let  $(1+x)^n$  be a function of  $n$  and denote it  $\phi n$ .

Then  $(1+x)^n \cdot (1+x)^m = (1+x)^{n+m}$  or  $\phi n \cdot \phi m = \phi(n+m)$

And you can verify this as an exercise of algebraic multi-rowed multiplication of infinite series as we have been doing above.

*When an algebraical multiplication, or other operation, such as hitherto been defined, can be proved to produce a certain result in cases where the letters stand for whole numbers, then the same results must be true when the letters stand for fractions or incommensurable numbers, and also when they are negative.*

Or -- what is true for **N** is true for **R**.  $(1+x)^{p/q}$  is true whether  $x$  is less than one or not. But for  $x$  greater than or equal to one, the series does not converge and is of no interest to us.

It follows that  $(1+x)^n = \phi n$  falls, by our earlier proof, into the form of  $c^n$  where  $c = \phi(1)$  and  $\phi(1)$  is shown above in the next to last line of the proof.

$$\begin{aligned} (1+x)^{1/2}: n &= 1/2 \quad (n-1)/2 = -1/4 \quad (n-2)/3 = -1/2 \\ \therefore \text{series} &= 1 + 1/2 \cdot x + 1/2 \cdot (-1/4) \cdot x^2 + 1/2 \cdot (-1/4) \cdot (-1/2) \cdot x^3 + \dots \\ &= 1 + 1/2 \cdot x - 1/8 \cdot x^2 + 1/16 \cdot x^3 - \dots \end{aligned}$$

It is not necessary to do more than tree terms when writing out an infinite series unless you are calculating its approximate value. Sometimes it is necessary to add the "+ ... + [general term] + ..." for clarity. But these four terms are basically the max.

$$\begin{aligned} n &= -1 \quad (n-1)/2 = -1 \quad (n-2)/3 = -1 \quad (n-3)/4 = -1 \therefore \\ (1+x)^{-1} &= 1 - x + x^2 - x^3 + \dots \quad (\text{but you knew that}) \end{aligned}$$

It is all the same whether we use  $(1 + x)^n$  or  $(a + b)^n$ . The coeff of the terms remains the same:  $n = 5$   $(n-1)/2 = 2$   $(n-2)/3 = 1$   $(n-3)/4 = 1/2$   $(n-4)/5 = 1/5$   $(n-5)/6 = 0$   
 So you can prove to yourself by plain multiplication of factors that

$$(a + b)^5 = a^5 + 5a^4b + 10a^3b^2 + 10a^2b^3 + 5ab^4 + b^5.$$

Some of you will quickly notice that the coeffs of the Binomial Theorem are both the terms of Pascal's Triangle and the number of combinations of  $n$  things taken from a set of  $m$  things. You can work out for yourself that the Binomial Theorem coeffs are  $C_{n|m}$ . Even I can do that. But Pascal's Triangle remains a mystery to me. What **was** he doing.

Pascal: "Hey, guys. Look at this weird triangle."

Fermat: "Oui. Beaucoup cool."

Newton: "I don't get it."

Pascal: "Look. The lines come from adding the values on the previous line like this."

Newton: "Sure seems like it. So?"

I'm sure that if there is a point, Newton saw it. I can't see it. But, okay, it is kind of cool. And if you will memorise 14641 for  $(a + b)^4$ , you can get a lot of coeffs faster than doing it Newton's Binomial Theorem way.

De Morgan was not one to fill his books with exercises. But if you care about mathematics, you should naturally play with its ideas. And I do mean **play**, because if it isn't fun to play with mathematics, you are on the wrong bus. De Morgan, in his *Elements of Algebra*, supplied five pages of exercises for the section on the Binomial Theorem which you can bang your head against by downloading the book on archive.org. The Binomial Theorem is one of the most important early ideas we acquire in algebra. Whatever time you spend playing with it is well-spent.

## Transcendental Series

Until the advent of the slide rule, calculations relied heavily on logarithms. You had logarithms base ten and base  $\epsilon$ . These are still used and are denoted as  $\log_{10} x$  or  $\log x$  for base 10 and as  $\ln x$  for base  $\epsilon$ . Say you had two big numbers,  $x$  and  $y$ , and needed the value of  $x/y$ . You look up the logarithms of  $x$  and  $y$  in a table and  $\log x/y = \log x - \log y$ . Easy enough. Take the result to the anti-log table to get your answer, which will be accurate to five or seven or nine digits depending on what you spent for your book of tables.

So in De Morgan's book, exponential ( $\epsilon$ ) and logarithmic series focused on calculations and the use of tables. But these series, as functions, are whoppingly important in everything from Calculus on. So we will use De Morgan to give us a sound basis for these two important functions and just skip over the mechanics of calculating with logarithms by hand.

**Def.** In  $ab$ ,  $a$  wrt  $b$  is a coeff and wrt  $ab$  is a factor. In  $a^b$ ,  $b$  wrt to  $a$  is an exponent and wrt  $a^b$  is a **logarithm**. And  $a$  wrt  $b$  is the **base** of the logarithm. In  $3^4$ , 4 is the log (base 3) of  $3^4$  or 81. In  $a^x$ ,  $x$  is the log (base  $a$ ) of  $a^x$ . Our notation for these is  $4 = \log_3 81$  and  $x = \log_a x$ . Again, when the base is 10, we write  $\log$  and not  $\log_{10}$ . And when the base is  $\epsilon$ , we write  $\ln$  or "natural logarithm".

To construct a system of logs base 10 we would solve the following equations:

$$10^x=1 \quad 10^x=2 \quad 10^x=3 \quad \text{and so on}$$

The solutions tend to be irrational numbers and so logs are approximations to some chosen degree of accuracy. In log tables,  $\log 2 = 0.30108$  if the logs run to five decimal places.

**Thm I:** Whatever the base, the log of 1 is 0.

**Proof**

$$\forall a, a^0 = 1 \therefore \log_a 1 = 0 \quad \blacksquare$$

**Thm II:** The log of the base itself is 1.

**Proof**

$$a^1 = a \therefore \log_a a = 1 \quad \blacksquare$$

**Thm III:** The logs of  $y$  and  $1/y$  are different signs of the same value.

**Proof**

$$y = a^x \therefore x = \log_a y$$

$$\therefore 1/y = a^{-x} \therefore -x = \log_a 1/y$$

$$\therefore \log_a 1/y = -\log_a y \quad \blacksquare$$

**Thm IV:** Given base  $a$ , if a value is between  $a^m$  and  $a^n$  ( $\cdot \cdot (a^m, a^n)$ ) then the log of the value is  $\cdot \cdot (m, n)$

**Proof**

Follows from definition of log.  $\blacksquare$



**Example**

	Base 10
Number · ·	Log · ·
1,10	0,1
10,100	1,2
100,1000	2,3
1,0.1	0,-1
0.1,0.01	-1,-2
0.01,0.001	-2,-3

**Thm V:** The log of a product equals the sum of the logs of its factors.

**Proof**

If  $P = a^p$ ,  $Q = a^q$ ,  $R = a^r$  then

$$PQR = a^{p+q+r} \therefore \log PQR = p + q + r = \log P + \log Q + \log R \blacksquare$$

**Thm VI:** In any division, the log is the difference of dividend and divisor (or numerator and denominator).

**Proof**

$$P/Q = a^{p-q} \therefore \log P/Q = p - q = \log P - \log Q \blacksquare$$

**Thm VII:** The log of  $P^m$  is found by multiplying log P times m.

**Proof**

$$\text{If } P = a^p \text{ then } P^m = a^{mp} \therefore \log P^m = mp = m \cdot \log P$$

**Thm VIII:** A negative number has no arithmetical log nor is a system of logs with a negative base feasible.

**Proof**

This is more a definition of logs than a proof. The eqn  $a^x = b$  has only one arithmetical soln and the others are not handy for logs. The same goes for negative bases.  $\blacksquare$

**Thm IX:** The logarithm of 0 is  $\infty$ .

**Proof**

If y diminishes without limit, then its log must increase without limit.

$$\begin{aligned} \log 1/2 &= -0.30103 \\ \log 1/4 &= -0.60206 \\ \log 1/8 &= -0.90309 \end{aligned}$$

You can see where this is going.  $\blacksquare$

A few examples just to solidify the theorems:

$$\begin{aligned} x \cdot 1 &= x & \log x + \log 1 &= \log x \\ x^1 &= x & 1 \cdot \log x &= \log x \\ \log_a ax &= \log_a a + \log_a x = 1 + \log_a x \\ \log x\sqrt{y} &= \log x + \log y^{1/2} = \log x + \frac{1}{2} \log y \\ \log (xy^3)/(pq^2) &= \log x + \frac{1}{3} \log y - \log p - 2 \log q \\ \log ((xy^3)/(pq^{-1}))^{-1} &= -1(\log x + 3 \log y - \log p - (-1)\log q) \\ &= -\log x - 3\log y + \log p - \log q \end{aligned}$$

Let's consider the series that leads to Euler's number  $\epsilon$ . If you expand  $(1 + 1/n)^n$  you get:

$$1 + 1 + (1 - 1/n)/2 + (1 - 1/n)/2 \cdot (1 - 2/n)/3 + \dots$$

And if you expand  $(1 + 1/n)^{nx}$  you get:

$$1 + x + x \cdot (x - 1/n)/2 + x \cdot (x - 1/n)/2 \cdot (x - 2/n)/3 + \dots$$

and  $(1 + 1/n)^{nx}$  is  $((1 + 1/n)^n)^x$  so

$$(1 + 1 + (1 - 1/n)/2 + \dots)^x = (1 + x + x \cdot (x - 1/n)/2 + \dots)$$

And these converge if  $1/n < 1$  or  $n > 1$ . If  $n \rightarrow \infty$  these are:

$$1 + 1 + 1/2! + 1/3! + \dots \text{ and } 1 + x + x^2/2! + x^3/3! + \dots$$

The first of these is Euler's  $\varepsilon$  and the second is the function  $\varepsilon^x$ . If you know any Calculus you can see in the series itself that the derivative of  $\varepsilon^x$  is  $\varepsilon^x$  which makes it so useful in mathematics that it will dog your every step from trigonometry on. So pay attention.

And remember that everything in mathematics is only what it is defined to be. As mathematics becomes more complicated as we progress, the complication goes no farther than the complicated expression which is before you on the page. Comprehend that and you are done; there is no mysterious dark region beyond this, evading your understanding. There is only each thing as you meet it in your progress.

The inverse fn of  $\varepsilon^x$  is  $\ln x$  or the **natural log** of  $x$  or log base  $\varepsilon$  of  $x$ . So with base  $\varepsilon$ , the  $\ln$  of  $x = 1 + x + x^2/2! + \dots$ . From this we have:

$$\varepsilon^{kx} = 1 + kx + 1/2!k^2x^2 + 1/3!k^3x^3 + \dots$$

And  $e^{kx} = (e^k)^x$ . So if  $\ln a = k$  then  $e^k = a$ . Then:

$$\varepsilon^{kx} = a^x = 1 + x \cdot \ln a + 1/2x^2(\ln a)^2 + \dots$$

So (do the math) if  $x \rightarrow 0$  then  $(a^x - 1)/x \rightarrow \ln a$ . De Morgan uses this to show you how to calculate  $\ln x$ , which our calculators handle for us. But the algebra of how you do this is very instructive. Watch what he does. We know that the series for  $\ln a$  is:

$$\ln a = (a - 1) - 1/2(a - 1)^2 + 1/3(a - 1)^3 - \dots$$

Let  $a = 1 + b$  then

$$\ln(1 + b) = b - b^2/2 + b^3/3 - \dots \quad [1]$$

Change  $b$  to  $-b$ :

$$\ln(1 - b) = -b - b^2/2 - b^3/3 - \dots \quad [2]$$

$$[2] - [1] = \ln((1+b)/(1-b)) =$$

$$2(b + b^3/3 + b^5/5 + \dots) \quad [3]$$

Let  $(1+b)/(1-b) = (1+x)/x$  then  $b = 1/(2x+1)$  and

$$\ln((1+x)/x) = \ln(x+1) - \ln x = 2(1/(2x+1) + 1/3 \cdot 1/(2x+1)^3 + 1/5 \cdot 1/(2x+1)^5 + \dots)$$

Make sure that you follow the logic of how  $b = 1/(2x+1)$  and why he chose  $(x+1)/x$ . This is the power of algebra. Practically speaking, this series allows you to calculate natural logs:

$$\begin{aligned} x &= 1 \ln 2 = 2(1/3 + 1/3 \cdot 1/27 + 1/5 \cdot 1/243 + \dots) \\ x &= 2 \ln 3 = \ln 2 + 2(1/5 + 1/3 \cdot 1/125 + 1/5 \cdot 1/3125 + \dots) \\ x &= 3 \ln 4 = \ln 3 + 2(\text{and so on.}) \end{aligned}$$

And the accuracy in the tables is only limited by how much time you spend hunched over your paper using nothing but a quill pen and arithmetic in the poor light of a smoking whale-oil lamp. De Morgan calculates  $\ln 2 = 0.69314718056$ , if you're curious. If you are more curious, convince yourself that you can construct such a table if you only calculate the value of  $\ln x$  when  $x$  is prime. We will close our section on algebra by looking at the uses of these important series.

**Lemma** Let  $f(x)$  be a fn:  $f(x+y)$  can be expanded as:  $A_0 + A_1y + A_2y^2 + \dots$ . Here  $A_i$  are functions only of  $x$ . Let  $i = \sqrt{-1}$  then in  $f(a + bi) + f(a - bi)$  the  $i$ 's disappear but in  $f(a+bi) - f(a-bi)$  they do not.

**Proof**

$$\begin{aligned} f(x+y) &= A_0 + A_1y + A_2y^2 + \dots \quad [A] \\ f(x-y) &= A_0 - A_1y + A_2y^2 - \dots \quad [B] \\ \text{Then } A + B &= 2A_0 + 2A_2y^2 + 2A_4y^4 + \dots \\ \text{and } A - B &= 2A_1y + 2A_3y^3 + 2A_5y^5 + \dots \\ \text{Now let } x &= a, y = ib \text{ where } i = \sqrt{-1}, i^2 = -1, i^3 = -i, i^4 = 1 \text{ and so on. Then} \\ y &= bi & y^5 &= b^5i \\ y^2 &= -b^2 & y^6 &= -b^6 \\ y^3 &= -b^3i & y^7 &= -b^7i \\ y^4 &= b^4 & y^8 &= b^8 \text{ and so on. Then} \\ f(a+bi) + f(a-bi) &= 2A_0 - 2A_2b^2 + 2A_4b^4 - \dots \\ f(a+bi) - f(a-bi) &= 2A_1bi - 2A_3b^3i + \dots \quad \blacksquare \end{aligned}$$

**Examples**

$$\begin{aligned} 1/(a+bi) + 1/(a-bi) &= 2a/(a^2+b^2) \\ 1/(a+bi) - 1/(a-bi) &= -2b/((a^2+b^2)i) \\ (a + bi)^n + (a - bi)^n &= 2^n - 2n \cdot (n-1)/2 \cdot a^{n-2}b^2 + \dots \\ (a + bi)^n - (a - bi)^n &= i(2na^{n-1}b - 2n \cdot (n-1)/2 \cdot (n-2)/3 \cdot a^{n-3}b^3 + \dots) \end{aligned}$$

We define **evenly even** as divby 4,8,...,4n and **oddly even** as divby 2, 6, 10, .... And our theorem holds if  $a = 0$  and  $n \in \mathbf{N}$ .

$$\begin{aligned} (bi)^n + (-bi)^n &= \begin{cases} 2b^n \text{ if } n \text{ evenly even} \\ 0 \text{ if } n \text{ odd} \\ -2b^n \text{ if } n \text{ oddly even} \end{cases} \\ (bi)^n - (-bi)^n &= \begin{cases} 0 \text{ if } n \text{ is even} \\ 2ib^n \text{ when } n \in \{1, 5, 9, \dots\} \\ -2ib^n \text{ when } n \in \{3, 7, 11, \dots\} \end{cases} \end{aligned}$$

If we apply these ideas to  $\epsilon^{ix}$  and  $\epsilon^{-ix}$ :

$$\begin{aligned} \epsilon^{ix} &= 1 + ix - x^2/2! - ix^3/3! + x^4/4! + \dots \\ \epsilon^{-ix} &= 1 - ix - x^2/2! + ix^3/3! + x^4/4! - \dots \\ (\epsilon^{ix} + \epsilon^{-ix})/2 &= 1 - x^2/2! + x^4/4! - x^6/6! + \dots \quad [A] \\ (\epsilon^{ix} - \epsilon^{-ix})/2i &= x - x^3/3! + x^5/5! - \dots \quad [B] \end{aligned}$$

Let  $\text{LHS}[A]$  be  $\varphi x$  and  $\text{LHS}[B]$  by  $\psi x$ . Now De Morgan doesn't tell you this until much later but  $\varphi x$  is cosine  $x$  and  $\psi x$  is sine  $x$ . The effort to really follow the rest of this section will be rewarded from trigonometry, through Calculus, and beyond.

$$\begin{aligned}(\varphi x)^2 &= (\varepsilon^{2ix} + 2\varepsilon^{ix}\varepsilon^{-ix} + \varepsilon^{-2ix})/4 \\(\psi x)^2 &= (\varepsilon^{2ix} - 2\varepsilon^{ix}\varepsilon^{-ix} + \varepsilon^{-2ix})/-4 \\(\varphi x)^2 + (\psi x)^2 &= (4\varepsilon^{ix}\varepsilon^{-ix})/4 = 1 \\(\varphi x)^2 - (\psi x)^2 &= (\varepsilon^{2ix} + \varepsilon^{-2ix})/2 = \varphi(2x) \\\varphi x \cdot \psi x &= (\varepsilon^{2ix} - \varepsilon^{-2ix})/4i = \frac{1}{2}\psi(2x)\end{aligned}$$

It follows that  $2\varphi x\psi x = \psi(2x)$ . You can use your ability to multiply infinite series to verify any of the above equalities using the RHS of the two eqns. Then it follows that:

$$\begin{aligned}\varphi(x + y) &= \varphi x\varphi y - \psi x\psi y \\\varphi(x - y) &= \varphi x\varphi y + \psi x\psi y \\\psi(x + y) &= \psi x\varphi y + \varphi x\psi y \\\psi(x - y) &= \psi x\varphi y - \varphi x\psi y\end{aligned}$$

Now consider how important the periodic (trig) fns are to the sciences. Combine that with the derivative of  $\varepsilon^x$  being  $\varepsilon^x$ , making it the poster-child for all of Calculus and you will realize how important [A] and [B] are. The fact that high school trig books no longer include these shows you just how dumbed-down education has become.

Let  $\varepsilon^{ix} = p$ ,  $\psi x/\varphi x = \chi x$  ( $\sin x/\cos x = \tan x$ )

Then  $1/i \cdot (p - 1/p)/(p + 1/p) = \psi x/\varphi x = \chi x$  or  $(p^2 - 1)/(p^2 + 1) = i\chi x$

$\therefore p^2 = (1 + i\chi x)/(1 - i\chi x)$  and from [3] a few pages back we get

$$\ln p^2 = 2(i\chi x + \frac{1}{3}(i\chi x)^3 + \dots) = 2i(\chi x - \frac{1}{3}(\chi x)^3 + \frac{1}{5}(\chi x)^5 - \dots)$$

$$\text{But } p^2 = \varepsilon^{2ix} \text{ or } \ln p^2 = 2ix \therefore x = \chi x - \frac{1}{3}(\chi x)^3 + \frac{1}{5}(\chi x)^5 - \dots$$

[A] and [B] are always convergent. The convergence can begin at any term by making  $x$  large enough. If  $x = 1000$ , convergence begins at the term  $x^{264}/264!$ . Also consider that because  $\varphi x^2 + \psi x^2 = 1$  the absolute value of  $\varphi x$  and  $\psi x$  is always less than unity.

We are going on to trigonometry now where we will see much of this again in a different context. Don't worry if your understanding of these trig series seems shaky or shallow. Understanding deepens with use and you haven't used these much, have you? Again, there is nothing more to them than their symbols on the page and their assigned meaning. Grasp that, "speak" it over and over through use, and you'll be fluent. Nothing is hidden.

## Trigonometry

Trigonometry (trig) was originally the **measurement of triangles** and was used in surveying, plain (plane) sailing, and other practical ways. But its mathematic has been expanded and deepened since those days.

*Trigonometry contains the **science of continually undulating magnitude**; meaning magnitude which becomes alternately greater and less, without any termination in the succession of increase and decrease. A function of  $x$  is continually undulating, when as  $x$  increases continually, say from 0 to  $\infty$ ,  $\phi x$  never becomes permanently increasing, nor permanently diminishing, nor permanently approaching a fixed limit.*

*All trigonometric functions are not undulating; but it may be stated that in common algebra nothing but infinite series undulate; in trigonometry, nothing but infinite series do not undulate.*

The simplest undulation is **periodic** or  $\forall x, \forall n \in \mathbf{N}$ , for period  $a$ ,  $\phi(x + na) = \phi x$ .

*Consideration of angular magnitudes must suggest periodic functions. Let a straight line, fixed at one extremity, revolve about that extremity. The total angle described may go on increasing ad infinitum: the angle is not a periodic magnitude, though beginners are apt to think so. But the direction indicated is periodic, though not a magnitude.*

The most common angular measure is to divide one complete revolution into 360 parts called **degrees**. Degrees are divided into 60 **minutes** and minutes into 60 **seconds**. Further division is indicated by decimal fractions. Degrees, minutes, and seconds are denoted  $^{\circ}$ ,  $'$ ,  $"$ . For example,  $18^{\circ} 47' 23'' .1774$  is the following fraction of a revolution:

$$18/360 + 47/(60 \cdot 360) + 23/(60^2 \cdot 360) + 1774/10^4 \cdot 1/(60^2 \cdot 360)$$

In mathematics, we measure angles not by degrees but by **radians**. In Euclid, we prove that circumferences of circles are proportional to their diameters. If  $\odot A$  (circle A) has circumference  $C_A$  and  $\odot B$  has  $C_B$  then the radii are  $1/2C_i = R_A$  and  $R_B$ . This leads to the proportions  $\odot A : \odot B :: R_A : R_B$  and Euclid can manipulate this proportion to prove more propositions. Mathematically this leads to  $\odot A \div R_A = \odot B \div R_B$  for all circles A,B. Therefore,  $\odot/R$  is the same for all circles and this value is  $2\pi$ . By measuring angles by fractions of  $2\pi$ , we generalize the measurement of angles. We are in effect saying that the circle at hand has a unit radius and this give the circumference a measure of  $2\pi$ . So there are  $2\pi$  radians in a revolution and  $90^{\circ} = 2\pi/4 = \pi/2$  radians. And so on, with the fractions.

Watch your mind when dealing with  $\pi$ . Because we define  $\pi$  by the average of increasingly doubled n-gons, inscribed and described on a circle, its representation is necessarily infinite -- as for any n-gon, we can double the sides and get a  $2n$ -gon. But  $\pi$  is only 3.14159 rounded off to the nearest one hundred thousandth. So  $2\pi$  is less than 6.3. This  $\pi$  thing is a small number which one weirdly tends to forget.

If  $\odot A$  is big and  $\odot B$  is tiny, then the angle **subtended** (or enclosed by)  $\pi/2$  subtends a much bigger arc in  $\odot A$  than in  $\odot B$ . But the measure remains the same for the angles. If  $\theta$  = radians,  $s$  = subtended arc,  $r$  = radius, we can relate all circles to the circle of radius one:

$$\theta : 1 :: s : r \text{ or } \theta = s/r$$

Note that, as  $\pi$  radians can be measured as  $180^\circ$ , each radian =  $180/\pi$  degrees. But  $2\pi$  is not the number 360 nor is  $\pi = 180$ , even though you actually run into nonsense like this in some books.  $2\pi$  **is measured by** 360 degrees.

We've talked about the form of number. Here are some forms identical to  $\cos 2\theta$  or the cosine of double the angle  $\theta$ :

$$\frac{\cos^2\theta - \sin^2\theta}{2\cos^2\theta - 1}$$

$$\frac{1 - 2\sin^2\theta}{1/(1 + \tan 2\theta \tan \theta)}$$

All of these are equivalent. But if you think they are all the same, try later in Calculus to find their derivative or take their integral. And if you were representing something in the world of experience then one of these would express it more clearly than the others. Only in the meaninglessness of tautology are all equivalent expressions the same.

### Basic Trig Functions

The most basic trigonometric functions are the sine and the cosine. These are the truth-grounds from which everything else is built.

Here, AB and DE are our **axes** intersecting at the **origin** C. CF is a **radius** which can rotate through any angle, which we denote as  $\theta = \angle FCA$ . CG is the projection of CF onto the x-axis and KC is the projection of CF onto the y-axis. But we usually refer to FG rather than KC and these are equal. By using the magnitude of CG and GF as x and y, the point F is at (x,y). Our  $\theta$  is positive when the line CF is rotated in a counter-clockwise direction. But we can measure any angle as negative by measuring the same angle from the clockwise rotation it would represent. Here, if  $\theta = 60^\circ$  then  $-\theta$  would be  $-300^\circ$  and if  $\theta = \pi/3$  then  $-\theta = -5\pi/3$ .

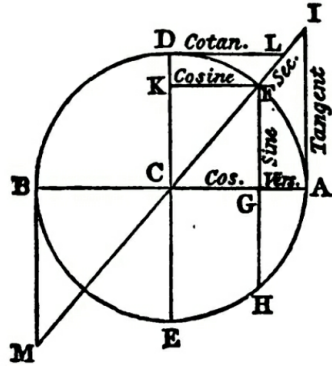

The axes divide the plane into four quadrants. As C is the origin (0,0), then x is positive in the direction of CA and negative in the direction of CB. Sym. y is positive in direction CD and negative in direction CE. Here, F is in quadrant I with x and y both positive. CM intersects  $\odot C$  in quadrant III where x and y are both negative. BD is the arc of quadrant II and EA of quadrant IV.

Let the abscissa CG be denoted x and the ordinate GF be denoted y and CF be the radius r. Then the primary trig fns are the ratios of these three magnitudes. If the angle of rotation is  $\theta$ , we have the following table:

	abscissa	base	is called the	abbreviated into	
$\frac{x}{r}$	rad.	hyp.	cosine of $\theta$	$\cos \theta$	Consider $\triangle FCG$ : CF is hypotenuse CG is base GF is perpendicular
$\frac{y}{r}$	rad.	hyp.	sine of $\theta$	$\sin \theta$	
$\frac{y}{x}$	abscissa	base	tangent of $\theta$	$\tan \theta$	We denote cosecant $\theta$ as $\text{csc}\theta$ .
$\frac{x}{y}$	ordinate	perpend.	cotangent of $\theta$	$\cot \theta$	Versed and coveredd sines are left in here because, though rare, they do still turn up when you least expect them and you might as well know what they are.
$\frac{r}{x}$	abscissa	base	secant of $\theta$	$\sec \theta$	
$\frac{r}{y}$	ordinate	perpend.	cosecant of $\theta$	$\text{cosec} \theta$	
	$1 - \cos \theta$		versed sine of $\theta$	vers $\theta$	
	$1 - \sin \theta$		coveredd sine of $\theta$	covers $\theta$	

I want to emphasize something here so that an important but trivial-seeming idea is clear in your mind. Because the basic functions above are ratios and because the proportion of  $\odot A : \odot B :: \text{diam}A : \text{diam}B$  extends to  $:: \text{radius}A : \text{radius}B :: CG \text{ or } GF \text{ on } A : CG \text{ or } GF \text{ on } B$  we can restrict trig to the **unit circle** of radius 1 and get the same value of the basic fns (ratios) there as on any other circle. This means that trig fns give **purely abstract numbers** as results, not magnitudes. The cosine of  $\pi/3$ , which is  $60^\circ$ , is  $1/2$  of the radius but the radius is any radius and on the unit circle  $1/2$  of 1 is  $1/2$ .

These functions can be considered as **projecting factors**. The fn  $\cos\theta$  turns radius  $r$  into its projection onto the  $x$ -axis;  $\sin\theta$ , turns  $r$  into its projection on the  $y$ -axis. The fn  $\tan\theta$  turns the projection on  $x$  into the projection on  $y$  and  $\cot\theta$  does the opposite.

You can see that three of the basic fns are the inverses of the other three or

$$\cos\theta \cdot \sec\theta = \sin\theta \cdot \csc\theta = \tan\theta \cdot \cot\theta = 1$$

Because  $\triangle FCG$  is a right triangle, from Euclid 1.47 we get:

$$\begin{array}{ll} \cos^2\theta + \sin^2\theta = 1 & [1] \\ 1 + \tan^2\theta = \sec^2\theta & [ [1] \times 1/\cos^2\theta ] \\ 1 + \cot^2\theta = \csc^2\theta & [ [1] \times 1/\sin^2\theta ] \end{array}$$

What are these kinds of eqns good for? That's a reasonable question. They naturally arise in many mathematical models. And in "pure" mathematics, it is possible to express unsolvable eqns in terms of trig fns to make them solvable. Go find a standard trig text if you want to try your hand at solving this kind of fn. But let's give you more to work with first.

$$\begin{array}{l} \text{From } 1 + \tan^2\theta = \sec^2\theta \Rightarrow \cos\theta = 1/\sqrt{1 + \tan^2\theta} \\ \text{Then } \sin\theta = \tan\theta/\sqrt{1 + \tan^2\theta} \\ \text{And if } \tan\theta = b/a \text{ then } \cos\theta = a/\sqrt{a^2 + b^2} \text{ and } \sin\theta = b/\sqrt{a^2 + b^2} \end{array}$$

You should be using our basic trig diagram at the beginning of this section to establish in your mind the form these are taking geometrically. Each fn can be expressed in terms of any one of the others. For example, if  $\sin\theta = t$ , then  $\cos\theta = \sqrt{1 - t^2}$  and  $\tan\theta = t/\sqrt{1 - t^2}$  and the other three are the inverses of these. As an exercise, let each of the basic fns =  $t$  and express the other five in terms of that  $t$ .

There are limits on the values the basic fns can take. Sine and cosine are always on the interval  $[-1,1]$ . Can you see this in the basic diagram? Therefore secant and cosine are always outside  $(-1,1)$ . But tangent and cotangent, being asymptotic, can have any real value on  $(-\infty, \infty)$ .

If you go back to the idea of the sign of  $x$  and  $y$  in each of the four quadrants, you can see that all fns are positive in quad I. In each of the other quads, only two fns are positive. Which ones are they? Note that the whole system of fns remains consistent if the radius is taken as a negative value.

All trig fns  $F$  are periodic or  $F\theta = F(\theta + 2\pi)$ , taking the same value at each point in each revolution even as the angle continues to increase or decrease. Most trig texts have the following table and then talk about it interminably. Best if you just study it and draw little diagrams to verify the values. Note that in De Morgan's day, they did not consider infinity as both positive and negative. Now we do,  $-\infty$  being on the "far left" of the number line and  $+\infty$  being on the "far right." Should any  $\infty$  in this next table be  $-\infty$ ?



<i>Arcual Angle</i>	0	$\frac{1}{2}\pi$	$\pi$	$\frac{3}{2}\pi$	$2\pi$
<b>Cosine</b>	1	0	-1	0	1
<b>Sine</b>	0	1	0	-1	0
<b>Tangent</b>	0	$\infty$	0	$\infty$	0
<b>Cotangent</b>	$\infty$	0	$\infty$	0	$\infty$
<b>Secant</b>	1	$\infty$	-1	$\infty$	1
<b>Cosecant</b>	$\infty$	1	$\infty$	-1	$\infty$
<b>Versed sine</b>	0	1	2	1	0
<b>Covered sine</b>	1	0	1	2	1
<i>Gradual Angle</i>	0°	90°	180°	270°	360°

From Euclid, we have the ideas of complementary and supplementary angles. If two angles add up to a right angle, they are complements of each other. And two which sum to two right angles are supplements of each other. A right angle is  $90^\circ$  or  $\pi/2$  and two right angles are  $180^\circ$  or  $\pi$ . In trig, you will often encounter  $\theta$  and  $\pi/2 - \theta$  as complements or  $\theta$  and  $180^\circ - \theta$  as supplements.

The cosine fn is an **even** fn of  $\theta$  or  $\cos(-\theta) = \cos\theta$ . Sine is an **odd** fn of  $\theta$  or  $\sin(-\theta) = -\sin\theta$ . This idea comes from the idea of even and odd powers. So  $\tan\theta$  is odd because:

$$\tan(-\theta) = \sin(-\theta)/\cos(-\theta) = -\sin\theta/\cos\theta = -\tan\theta$$

If  $r$  and  $\theta$  are given, we can add or subtract right angles to  $\theta$ , thereby placing the angle in four positions. These relations are common occurrences and coming to an understanding of the following table by use of diagrams is recommended.

Angle.	Absc.	Ordin.	Conclusions.
$\theta$	$x$	$y$	
$\frac{1}{2}\pi - \theta$	$y$	$x$	$\cos(\frac{1}{2}\pi - \theta) = \sin\theta$ , $\sin(\frac{1}{2}\pi - \theta) = \cos\theta$ , $\tan(\frac{1}{2}\pi - \theta) = \cot\theta$ ,
$\frac{1}{2}\pi + \theta$	$-y$	$x$	$\cos(\frac{1}{2}\pi + \theta) = -\sin\theta$ , $\sin(\frac{1}{2}\pi + \theta) = \cos\theta$ , $\tan(\frac{1}{2}\pi + \theta) = -\cot\theta$ ,
$\pi - \theta$	$-x$	$y$	$\cos(\pi - \theta) = -\cos\theta$ , $\sin(\pi - \theta) = \sin\theta$ , $\tan(\pi - \theta) = -\tan\theta$ ,
$\pi + \theta$	$-x$	$-y$	$\cos(\pi + \theta) = -\cos\theta$ , $\sin(\pi + \theta) = -\sin\theta$ , $\tan(\pi + \theta) = \tan\theta$ ,
$\frac{3}{2}\pi - \theta$	$-y$	$-x$	$\cos(\frac{3}{2}\pi - \theta) = -\sin\theta$ , $\sin(\frac{3}{2}\pi - \theta) = -\cos\theta$ , $\tan(\frac{3}{2}\pi - \theta) = \cot\theta$ ,
$\frac{3}{2}\pi + \theta$	$y$	$-x$	$\cos(\frac{3}{2}\pi + \theta) = \sin\theta$ , $\sin(\frac{3}{2}\pi + \theta) = -\cos\theta$ , $\tan(\frac{3}{2}\pi + \theta) = -\cot\theta$ ,
$2\pi - \theta$	$x$	$-y$	$\cos(2\pi - \theta) = \cos\theta$ , $\sin(2\pi - \theta) = -\sin\theta$ , $\tan(2\pi - \theta) = -\tan\theta$ .

Those "conclusions" are true of all angles. The following case are perhaps the most important:

1. Fns of complements are cofns:  $\sin(\pi/2 - \theta) = \cos\theta$  and  $\cos(\pi/2 - \theta) = \sin\theta$
2. Supplements have same sine:  $\sin(\pi - \theta) = \sin\theta$
3. Opposite quads have same tangent:  $\tan(\pi + \theta) = \tan\theta$
4. Any quad x and quad x+3 have same cosine:  $\cos(2\pi - \theta) = \cos\theta$
5.  $\cos(\pi/2 + \theta) = -\sin\theta$                        $\cos(\pi - \theta) = -\cos\theta$   
 $\sin(\pi/2 + \theta) = \cos\theta$                                $\tan(\pi - \theta) = -\tan\theta$

Validate the following: For  $m \in \mathbf{Z}$ ,

Angles with same sine:  $2m\pi + \theta$  and  $(2m+1)\pi - \theta$

Angles with same cosine:  $2m\pi + \theta$  and  $2m\pi - \theta$

Angles with same tangent:  $m\pi + \theta$

Each sine has one cosecant. Each cosine has one secant. Each tangent has one cotangent. But in every other case, each fn has two fns of every other kind, one positive and one negative:

$$\cos\theta = \pm\sqrt{1 - \sin^2\theta} \qquad \tan\theta = \pm\sqrt{1 - \cos^2\theta}/\cos\theta$$

Because, in our basic diagram,  $\Delta FCG$  is always a  $\perp\Delta$  (right triangle), we can easily calculate the values of  $45^\circ$ ,  $60^\circ/30^\circ$ ,  $18^\circ/72^\circ$ ,  $15^\circ/75^\circ$ . For instance,  $45^\circ$  or  $\pi/4$  has equal projections upon the axes. So by Euclid 1.47,  $a^2 + b^2 = c^2 \therefore 2a^2 = 1 \therefore a = b = \sqrt{2}/2$ . For  $18^\circ$ , we can use Euclid 4.10 with an isos $\Delta$  (isosceles triangle) with an apex angle of  $36^\circ$ . Combined with Euclid 2.11, we get  $\sin 18^\circ = \frac{1}{4}(\sqrt{5} - 1)$ . You should go look up these Euclid citations to see what you are missing. Without Euclid, you are missing a lot. For the above listed angles, our values are:

$\frac{1}{2}\pi$	$15^\circ$	<b>sine</b>	<b>cosine</b>	<b>tangent</b>	<b>cotangent</b>	$75^\circ$	$\frac{1}{2}\pi$
		$\frac{\sqrt{6}-\sqrt{2}}{4}$	$\frac{\sqrt{6}+\sqrt{2}}{4}$	$2-\sqrt{3}$	$2+\sqrt{3}$		
$\frac{1}{6}\pi$	$18^\circ$	$\frac{\sqrt{5}-1}{4}$	$\frac{\sqrt{10+2\sqrt{5}}}{4}$	$\frac{\sqrt{5}-1}{\sqrt{10+2\sqrt{5}}}$	$\frac{\sqrt{10+2\sqrt{5}}}{\sqrt{5}-1}$	$72^\circ$	$\frac{5}{6}\pi$
$\frac{1}{6}\pi$	$30^\circ$	$\frac{1}{2}$	$\frac{1}{2}\sqrt{3}$	$\frac{1}{\sqrt{3}}$	$\sqrt{3}$	$60^\circ$	$\frac{1}{3}\pi$
$\frac{1}{4}\pi$	$45^\circ$	$\frac{1}{2}\sqrt{2}$	$\frac{1}{2}\sqrt{2}$	1	1	$45^\circ$	$\frac{1}{4}\pi$
		<b>cosine</b>	<b>sine</b>	<b>cotangent</b>	<b>tangent</b>		

There are some important limits regarding these basic and fundamental trig fns. The first relation is  $\sin\theta/\theta$ . If  $\theta$  is  $1/2n \cdot 2\pi$  for  $\forall n \in \mathbf{N}$ , we can consider the n-gon (polygon) inscribed in a circle radius r such that  $\theta$  subtends each side. Then each side is  $2r \cdot \sin\theta$  and the circumference is  $\pi 2r = 2n\theta r$ . The ratio of side:circumference is  $\sin\theta/\theta$ . And this ratio as  $n \rightarrow \infty$  or as  $\theta \rightarrow 0$  has a limit of 1. At  $5^\circ$ , the radian measure is 0.872665 and the sine is 0.0871557. So for "small" angles, the radian measure is "practically" equal to the sine.

Then for  $\tan\theta/\theta = 1/\cos\theta \cdot \sin\theta/\theta$ , the limit as  $\theta \rightarrow 0$  must also be 1 or as  $\theta \rightarrow 0$  then  $\tan\theta \rightarrow \theta$ . Finally,  $(1 - \cos\theta)/\theta = \theta/(1 + \cos\theta) \cdot (\sin\theta/\theta)^2$ . So as  $\theta \rightarrow 0$ , then  $1 - \cos\theta \rightarrow 0$ . But  $1 - \cos\theta$  diminishes much more rapidly than  $\theta$ .  $\forall n \in \mathbf{N}$ ,  $\theta > n(1 - \cos\theta)$  at some point before  $\theta = 0$ . When  $\theta = 5^\circ$ ,  $\theta > 20(1 - \cos\theta)$ .

From these, it follows that

$$\frac{\sin a\theta}{\sin b\theta} = \frac{\sin a\theta}{a\theta} \cdot \frac{b\theta}{\sin b\theta} \cdot \frac{a}{b}$$

has the limit of  $a/b$  as  $\theta \rightarrow 0$ . And that as  $n \rightarrow \infty$ ,  $(n \sin \theta)/n \rightarrow \theta$ .

$\sec \theta - \tan \theta = (1 - \sin \theta)/\cos \theta = \cos \theta/(1 + \sin \theta) = 0$  when  $\theta = \pi/2$   
 $\therefore \theta \rightarrow \pi/2$  (or  $3\pi/2$ ),  $\tan \theta \rightarrow \sec \theta$  Sym.  $\cot \theta \rightarrow \csc \theta$  as  $\theta \rightarrow 0$  (or  $\pi$ )

Again,  $1 - \cos \theta = \sin^2 \theta/(1 + \cos \theta) = \theta^2/(1+1)$  for small  $\theta$ .

## Functions of 2+ Angles

The most important relation after  $\sin^2\theta + \cos^2\theta = 1$  is the sine and cosine of the sum and difference of two angles. De Morgan derives this in two different ways in his later book. In my notes, I have six or eight of these proofs of two angles. All are instructive. But I am giving you Elias Loomis's from his *Elements of Geometry*. Loomis isn't as entertaining as De Morgan. But his books, in their way, are every bit as good. This is the simplest and clearest of these proofs.

Given any two arcs, AB, BD. Make BE = BD. We find the sine of AD, the sum, and of AE, the difference, of these arcs.

$AB = a$   $BD = b \therefore AD = a+b$  and  $AE = a-b$   
 Add chord DE and radius  $CB = R = 1$ .  
 $\text{arc}DB = \text{arc}BE \therefore DF = FE \therefore DE \perp CB$  (Euclid 3.3)  
 Add  $EG, BH, FI, DK$  all  $\perp CA$  and  $EL, FM \parallel AC$   
 $\triangle BCH \sim \triangle FCI$  (Euclid 6.4)  
 $\therefore CB:CF::BH:FI$  or  $R : \cos b :: \sin a : FI$   
 $\therefore FI = (\sin a \cdot \cos b)/R$   
 Sym.  $CB:CF::CH:CI$  or  $R : \cos b :: \cos a : CI$   
 $\therefore CI = (\cos a \cdot \cos b)/R$   
 $\triangle DFM \sim \triangle CBH$   
 $\therefore CB:DF::CH:DM$  or  $R : \sin b :: \cos a : DM$   
 $\therefore DM = (\cos a \cdot \sin b)/R$   
 Sym.  $CB:DF::BH:FM$  or  $R : \sin b :: \sin a : FM$   
 $\therefore FM = (\sin b \cdot \sin a)/R$

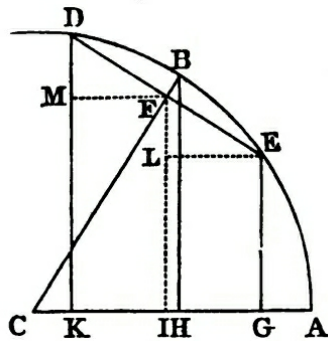

$FI + DM = DK = \sin(a + b)$   
 $CI - FB = CK = \cos(a + b)$   
 $FI - FL = EG = \sin(a - b)$   
 $CI + EL = CG = \cos(a - b)$   
 $\therefore \sin(a + b) = \sin a \cdot \cos b + \cos a \cdot \sin b$   
 $\cos(a + b) = \cos a \cdot \cos b - \sin a \cdot \sin b$   
 $\sin(a - b) = \sin a \cdot \cos b - \cos a \cdot \sin b$   
 $\cos(a - b) = \cos a \cdot \cos b + \sin a \cdot \sin b$  ■

Loomis left the results as a fraction over R. I made  $R = 1$  as we only consider the unit circle in trig nowadays. For calculating actual circles, use the actual radius. From these relations, an avalanche follows. You can work any of these out with what you know so far as an exercise:

### Double Angles

$$\begin{aligned}
 \sin 2\theta &= 2\sin\theta\cos\theta \\
 \cos 2\theta &= \cos^2\theta - \sin^2\theta \\
 &= 1 - 2\sin^2\theta \\
 &= 2\cos^2\theta - 1 \\
 1 + \cos 2\theta &= 2\cos^2\theta \\
 1 - \cos 2\theta &= 2\sin^2\theta \\
 \tan^2\theta &= (1 - \cos 2\theta)/(1 + \cos 2\theta) \\
 \cot^2\theta &= (1 + \cos 2\theta)/(1 - \cos 2\theta)
 \end{aligned}$$

$$\begin{aligned}
 \sin\theta &= 2\sin(\theta/2)\cos(\theta/2) \\
 \cos\theta &= \cos^2(\theta/2) - \sin^2(\theta/2) \\
 &= 1 - 2\sin^2(\theta/2) \\
 &= 2\cos^2(\theta/2) - 1 \\
 1 + \cos\theta &= 2\cos^2(\theta/2) \\
 1 - \cos\theta &= 2\sin^2(\theta/2) \\
 \tan^2(\theta/2) &= (1 - \cos\theta)/(1 + \cos\theta) \\
 \tan^2(\pi/4 - \theta/2) &= (1 - \sin\theta)/(1 + \sin\theta)
 \end{aligned}$$

**Half Angles**

$$\begin{aligned} \sin a &= 2\sin(a/2)\cos(a/2) & \cos a &= \cos^2(a/2) - \sin^2(a/2) \\ \text{We can take} & \cos^2(a/2) + \sin^2(a/2) = 1 \\ \text{Subtract} & \cos^2(a/2) - \sin^2(a/2) = \cos a \\ \text{And get} & 2\sin^2(a/2) = 1 - \cos a \\ \text{Or add} & 2\cos^2(a/2) = 1 + \cos a \\ \therefore \sin(a/2) &= \sqrt{(1/2 - 1/2 \cdot \cos a)} & \cos(a/2) &= \sqrt{(1/2 + 1/2 \cdot \cos a)} \end{aligned}$$

**Products of Functions**

$$\begin{aligned} \sin(a+b) + \sin(a-b) &= 2 \cdot \sin a \cdot \cos b & \sin(a+b) - \sin(a-b) &= 2 \cdot \cos a \cdot \sin b \\ \cos(a+b) + \cos(a-b) &= 2 \cdot \cos a \cdot \cos b & \cos(a-b) - \cos(a+b) &= 2 \cdot \sin a \cdot \sin b \end{aligned}$$

**Tangent Functions**

$$\tan(a+b) = \frac{\sin(a+b)}{\cos(a+b)} = \frac{\sin a \cos b + \cos a \sin b}{\cos a \cos b - \sin a \sin b}$$

(divide by  $\cos a \cos b$ )

$$= \frac{\tan a + \tan b}{1 - \tan a \tan b}$$

Sym.  $\tan(a-b) = \frac{\tan a - \tan b}{1 + \tan a \tan b}$

$$\tan 2\theta = \frac{2\tan\theta}{1 - \tan^2\theta} \quad \tan\theta = \frac{2 \tan(\theta/2)}{1 - \tan^2(\theta/2)}$$

$$\begin{aligned} \tan a + \tan b &= \sin(a+b)/(\cos a \cdot \cos b) \\ \tan a - \tan b &= \sin(a-b)/(\cos a \cdot \cos b) \end{aligned}$$

The above is about half the avalanche as found in De Morgan, Loomis, or any other decent trig text. But you should be able to **derive** all of the above from the  $\cos(a+b)/\sin(a+b)$  proof. And there are trig formula tables out there if you need them. And only when you are solving these puppies will you know what you will need based on the form of things.

We could have  $\cos 3a = \cos(a+a+a)$  and treat it as  $\cos((a+a) + a)$ . Then this is

$$\begin{aligned} \cos(a+a)\cos a - \sin(a+a)\sin a \\ = (\cos a \cos a - \sin a \sin a)\cos a - (\sin a \cos a + \cos a \sin a)\sin a \end{aligned}$$

and so on. Let  $c = \cos a$ ,  $s = \sin a$ , and recall that  $M_n$  is the combination of  $m$  things taken from  $n$  things, which you had better be able to compute in your sleep. Our  $\cos(a+a+a)$  is  $\cos 3a$ . If you wrote out the work for  $3a$  and  $4a$  you would see a pattern appear:

$$\begin{aligned} \cos^n \theta &= c^n - 2_n c^{n-2} s^2 + 4_n c^{n-4} s^4 - 6_n c^{n-6} s^6 + \dots \\ \sin^n \theta &= 1_n c^{n-1} s - 3_n c^{n-3} s^3 + 5_n c^{n-5} s^5 - 7_n c^{n-7} s^7 + \dots \\ (c+s)^n &= c^n + 1_n c^{n-1} s + 2_n c^{n-2} s^2 + \dots \end{aligned}$$

So we can calculate  $\cos(n\theta)$  and  $\sin(n\theta)$  like this: let  $n = 4$

$$(c+s)^4 = c^4 + 4c^3s + 6s^2c^2 + 4cs^3 + s^4$$

I told you to memorise "14641". So  $\cos(n\theta)$  gets the odd terms and  $\sin(n\theta)$  gets the even terms.

$$\cos 4\theta = c^4 + 6c^2s^2 + s^4 \qquad \sin 4\theta = 4c^3s + 4cs^3$$

But the signs alternate positive negative in these results. So finally we have:

$$\cos 4\theta = c^4 - 6c^2s^2 + s^4 \qquad \sin 4\theta = 4c^3s - 4cs^3$$

It follows that to find the sine or cosine of the nth part of an angle, we solve an n<sup>o</sup> eqn. Or given sine of angle b, to trisect the angle we need sine of b/3. Let  $x = \sin b/3$  then

$$b = 3(1 - x^2)x - x^3 = 3x - 4x^3 \quad \text{or} \quad 4x^3 - 3x + b = 0$$

If  $b = 30^\circ$ , this is  $8x^3 - 6x + 1 = 0$ . De Morgan, just like today's computers but with a lot more work, could extract a root of this eqn equal to 0.173648177867 which is the sine of  $10^\circ$ . This eqn has three real roots and they are the sines of  $10^\circ$ ,  $50^\circ/130^\circ$ , and  $250^\circ$ . This also shows that trisecting an angle by direct Euclidean construction is impossible as a ruler is a first degree eqn and a compass is only one of many second degree eqns. Interestingly, the Greeks constructed the cissoid curve to trisect angles.

Let's find the infinite series for sine and cosine. First we have to determine that as  $n \rightarrow \infty$ , then  $(\cos(x/n))^n$  has a finite limit. If we take  $n: x/n \in (-\pi/2, \pi/2)$  we can use one of the formulae above (which one?) to show:

$$\cos^2(x/2n) = (1 + \cos(x/n))/2 > (\cos(x/n) + \cos(x/n))/2 > \cos(x/n)$$

or

$$(\cos(x/2n))^{2n} > (\cos(x/n))^n$$

If we take  $\cos x$ ,  $(\cos(x/2))^2$ ,  $(\cos(x/4))^4$ , ... we have a series of increasing terms, none of which exceed unity. So they have a finite limit L. Now consider any term in  $\cos(n\theta)$  or  $\sin(n\theta)$ :

$$M_n c^{n-m} s^m = n \cdot (n-1) / 2 \cdot (n-2) / 3 [\text{m factors}] \cdot (n-m+1) / m \cdot (\cos\theta)^{n-m} (\sin\theta)^m$$

Let  $n\theta = z$  which is a **fixed angle** where  $\theta = z/n$  then as  $n \rightarrow \infty$ ,  $\theta \rightarrow 0$ . Take our general term above, divide by  $(\cos\theta)^n$ , multiply and divide it by  $\theta$  m times and it becomes:

$$n\theta \cdot (n\theta - \theta) / 2 \cdot (n\theta - 2\theta) / 3 \cdots (n\theta - (m+1)\theta) / m \cdot 1/\theta^m \cdot (\sin\theta)^m / (\cos\theta)^m$$

or

$$z (z-\theta) / 2 (z-2\theta) / 3 \cdots (z - (m+1)\theta) / m \cdot (\tan\theta/\theta)^m$$

Note that reading that last bit will do you **no good**. Take the general term and actually derive the  $\tan\theta$  term. Here, as  $\theta \rightarrow 0$ , the z-product  $\rightarrow z^m/m!$  for any m. Then from the above derivations of  $\cos(n\theta)$  and  $\sin(n\theta)$  we have:

$$(\cos z)/L = 1 - z^2/2! + z^4/4! - \cdots \quad \text{and} \quad (\sin z)/L = z - z^3/3! + z^5/5! \cdots$$

Go back to the algebra section on convergence to see that these converge. If  $z = 0$ , then  $\cos\theta = L$  or  $L = 1$  from  $(\cos z)/L$ . From  $(\sin z)/L$  divide both sides by z, let  $z \rightarrow 0$ , and as  $(\sin z)/z \rightarrow 1$  then  $L \rightarrow 1$ . Remembering that z is any angle  $\theta$ , we have:

$$\cos z = 1 - z^2/2! + z^4/4! - z^6/6! + z^8/8! - \dots$$

$$\sin z = z - z^3/3! + z^5/5! - z^7/7! + z^9/9! - \dots$$

By inspection here,  $\cos z$  is an even fn,  $\sin z$  is an odd fn, and for small  $z$ ,  $\sin z = z$  and  $\cos z = 1 - z^2/2$ . If you have sufficient faith in your polynomial division, you can prove that

$$\tan z = z^3/3 + 2z^5/15 + 17z^7/315 + \dots$$

and everyone, according to De Morgan, should be able to use these last three infinite series to verify  $\cos^2 z + \sin^2 z = 1$ ,  $\cos^2 z - \sin^2 z = \cos 2z$ , and  $2\sin z \cos z = \sin 2z$ . If you shy away from long calculations like this, there is again a good chance that you are on the wrong bus. Just don't think you have to do them all. Do some. Do one. But do enough **for you**.

De Morgan goes on to derive two more series to express  $\cos^n \theta$  and  $\sin^n \theta$  in terms of  $\cos(n\theta)$  and  $\sin(n\theta)$ . These allow him to show things like

$$\sin 2\theta = 1/(\cot \theta + \tan \theta) \quad \text{and} \quad \cos 2\theta = 1/(1 + \tan 2\theta \tan \theta)$$

which you could try to prove without his series. It might not be possible. My thought here is that if you can understand and derive all the trigonometry in this section up to this point, you have a substantial basis. In De Morgan's time, much of trig was used for numerical calculation, especially in astronomy which is full of those very small angles he talks about. But these periodic functions are still a huge part of engineering and mathematics. Make sure that you **have developed** a substantial basis with these ideas. Then you should be able to handle whatever trigonometry arises along your line of progress.

## Inverse Functions

As you know, the inverse of  $\varphi x$  is  $\varphi^{-1}(x)$ :  $\varphi^{-1}(\varphi(x)) = x$ . So for  $\cos x$ , we have  $\cos^{-1}(\cos x) = x$ . The fn  $\cos(x)$  is a value and  $\cos^{-1}x$  is an angle which has the cosine  $x$ . Note that any trig inverse fn has infinite values because if  $\theta$  has cosine =  $x$  then so does  $2m\pi \pm \theta$  for  $m \in \mathbf{N}$ . We generally use the smallest value of the angle:

$$\begin{aligned}\cos^{-1} \cos \theta &= 2m\pi \pm \theta \\ \sin^{-1} \sin \theta &= 2m\pi + \theta \text{ or } (2m+1)\pi - \theta \\ \tan^{-1} \tan \theta &= m\pi + \theta = \cot^{-1} \cot \theta \\ \cos^{-1} \sin \theta &= 2m\pi \pm (\pi/2 - \theta) \\ \tan^{-1} \cot \theta &= m\pi + (\pi/2 - \theta)\end{aligned}$$

What can be expressed in trig fns can be *expressed in inverse language*:

### Examples

1)

$$\begin{aligned}\cos(2\sin^{-1}x) &= 1 - 2x^2 \\ \text{This is merely } \cos 2\theta &= 1 - 2\sin^2x \text{ or} \\ \text{the cosine of double } \mathbf{any} \text{ angle whose sine is } x &\text{ is } 1 - 2x^2\end{aligned}$$

2)

$$\begin{aligned}\tan^{-1}x + \tan^{-1}y &= \tan^{-1}((x+y)/(1-xy)) \\ \text{Or any angle whose tangent is } x, \text{ augmented by any angle whose tangent is } y, &\text{ is} \\ \mathbf{one} \text{ of the angles represented by this fraction.}\end{aligned}$$

### Proof

$$\begin{aligned}\tan(\varphi + \theta) &= (\tan \varphi + \tan \theta) / (1 - \tan \varphi \tan \theta) \quad [1] \\ \varphi + \theta &= \tan^{-1}([1]) \text{ or } \varphi + \theta \text{ is } \mathbf{one} \text{ of the angles for which this is true } \blacksquare\end{aligned}$$

Try to interpret  $\sin(\cos^{-1}x) = (1 - x^2)^{1/2}$  and  $\sin(3\sin^{-1}x) = 3x - 4x^3$  in this way.

A multiplicity of angle solns permeates trigonometry. In  $\cos^2\theta + \sin^2\theta = 1$ , any  $\theta$  is a soln. If you solve a trig eqn in any common trig text, you often get a different soln for each trig fn you solve for. Sometimes there is only one soln.

There is room for considerable thought in trigonometry.

Those last two problems of interpretation were De Morgan's. Here's another which shows his sense of humor and his faith in self-taught students:

$$\text{Show that } \cos \sec^{-1} \sin \tan^{-1} \cos \tan^{-1} \sin \cos^{-1} \tan \sin^{-1}x = ((3 - 4x^2)/(1 - x^2))^{1/2}$$

De Morgan's chapter on inverse fns is not much longer than this one. At the end, he writes:

*This is a chapter on language and some of the preceding examples are merely hard phrases to be construed from trigonometry into algebra. But such transformations have an important use in calculation.*



For De Morgan, mathematics is a **language** which must **always** express **meaning**. And while he never uses the phrase "the form of number", he is continually calling our attention to it. Here is one of his examples from his chapter that points to the form of number:

$$\begin{aligned} (a^2 + b^2 - 2ab \cdot \cos(c))^{1/2} &= ( (a+b)^2 - 2ab(1 + \cos(c)) )^{1/2} \\ &= (a+b) \left( 1 - \frac{4ab \cdot \cos^2(c/2)}{(a+b)^2} \right)^{1/2} \\ &= (a+b) \cos \sin^{-1} \left( \frac{2\sqrt{ab} + \cos(c/2)}{(a+b)} \right) \end{aligned}$$

Can you justify that to yourself?

## Complex Numbers

If we look at the series we derived for  $\sin z$  and  $\cos z$  and let  $z = \theta$ , we see that each term is one of those in  $\epsilon^\theta$  from our algebra section. And we can easily deduce:

$$\cos\theta + k \cdot \sin\theta = 1 + k\theta - \theta^2/2! - k\theta^3/3! + \theta^4/4! + k\theta^5/5! - \dots$$

If there existed a  $k$ :  $k^2 = -1$ ,  $k^3 = -k$ ,  $k^4 = 1$ ,  $k^5 = k$  and so on then  $\cos\theta + k\sin\theta = \epsilon^{k\theta}$ . Mathematics **chose** to create the symbol **i** to be exactly such a  $k \therefore i = \sqrt{-1}$  which, while algebraically impossible, enables the entire field of complex number and complex analysis.

In 1834, Hankel published his *Principle of Permanence*:

1. *Any number combination which gives no already-existing number is to be given such an interpretation that the combination can be handled according to the same rules as the previous numbers.*
2. *Such combination is to be defined as number, thus enlarging the number idea.*
3. *Then the usual laws (freedoms) are to be proved to hold for it.*
4. *Equal, greater, and less are to be defined in the larger domain.*

Think about what it means that laws are freedoms and that #2 comes before #3.

So we have  $e^{i\theta} = \cos\theta + i \cdot \sin\theta$  and  $(\cos\theta + i \cdot \sin\theta)(\cos\phi + i \cdot \sin\phi) = \cos(\theta+\phi) + i \cdot \sin(\theta+\phi)$ . So from algebra, we can say that if  $f(\theta) = (\cos\theta + i \cdot \sin\theta)$  then  $f\phi \cdot f\theta = f(\phi+\theta)$  and  $f$  must be some  $c^\theta$  where  $c$  is independent of  $\theta$ . Then

$$\frac{c^\theta - 1}{\theta} = \frac{\cos\theta - 1}{\theta} + i \frac{\sin\theta}{\theta} \quad \text{Let } \theta \rightarrow 0 \text{ and } \ln c = (0 + i) \text{ or } c = e^i \text{ and } c^\theta = \epsilon^{i\theta}$$

If  $\epsilon^{i\theta} = \cos\theta + i \cdot \sin\theta$  then  $\epsilon^{-i\theta} = \cos\theta - i \cdot \sin\theta$ .  $\therefore \cos\theta = (\epsilon^{i\theta} + \epsilon^{-i\theta})/2$  and  $\sin\theta = (\epsilon^{i\theta} - \epsilon^{-i\theta})/2i$ . You can prove for yourself that  $(\cos\theta + i \cdot \sin\theta)^n = \cos(n\theta) + i \cdot \sin(n\theta)$ . This is **De Moivre's Theorem**. In this form of number,  $\cos\theta + i \cdot \sin\theta$  is a quantity which if squared or cubed doubles or triples  $\theta$ , which is an angle. Reciprocals take a different form as you can see here:

$$(\cos\theta + i \cdot \sin\theta)(\cos\theta - i \cdot \sin\theta) = \cos^2\theta + \sin^2\theta = 1$$

If  $n \in \mathbf{Z}$  for  $\forall \theta: \theta = \theta + 2m\pi$  then  $n\theta = n\theta + 2nm\pi$  in **one** direction only, if we view our radius of the angle as a direction. But if  $n \in \mathbf{Q}$ :  $n = p/q$  in lowest terms then  $n\theta$  indicates exactly  $q$  directions. For  $n(\theta + 2m\pi) = p\theta/q + 2mp\pi/q$  which indicates the same direction for any two values of  $m, m'$ ,  $m''$  where  $2m'p/q - 2m''p/q$  is an even integer or  $(m' - m'')p/q$  is any integer. Since  $p(p, q)$ , this means  $m' - m''$  divby  $q$ . We get all the directions by taking  $m = \{0, 1, 2, 3, \dots, (q-1)\}$ . The directions are

$$p\theta/q, p\theta/q + p2\pi/q, \dots, p\theta/q + (q-1)2\pi/q.$$

And from number theory, dividing  $mp$  by  $q$  gives different remainders here and the directions become

$$p\theta/q, p\theta/q + 1 \cdot 2\pi/q, p\theta/q + 2 \cdot 2\pi/q, \dots, p\theta/q + (q-1)2\pi/q$$

If follows  $(\cos\theta + i\sin\theta)^{p/q} = \cos(p/q \cdot \theta) + i\sin(p/q \cdot \theta)$ . If  $\cos\theta + i\sin\theta$  is a solution of  $(\cos\theta + i\sin\theta)^n$  then  $\cos\theta - i\sin\theta$  solves  $(\cos\theta - i\sin\theta)^n$ . Then if  $\sin\theta = 0$  and  $\cos\theta = \pm 1$  both solns solve both eqns. With that in mind, here are the twelve roots of 1 and -1 (or  $\theta=0$  and  $\theta=\pi$ ), where the first soln is  $\pi/12$ :

12th roots of unity for 1		12th roots of unity for -1	
$\cos 0 \pm i\sin 0$	1	$\cos 15 \pm i\sin 15$	$1/4(\sqrt{6+\sqrt{2}}) \pm i/4(\sqrt{6-\sqrt{2}})$
$\cos 30 \pm i\sin 30$	$\sqrt{3}/2 \pm i/2$	$\cos 45 \pm i\sin 45$	$\sqrt{2}/2 \pm i\sqrt{2}/2$
$\cos 60 \pm i\sin 60$	$1/2 \pm i\sqrt{3}/2$	$\cos 75 \pm i\sin 75$	$1/4(\sqrt{6-\sqrt{2}}) \pm i(\sqrt{6+\sqrt{2}})$
$\cos 90 \pm i\sin 90$	$\pm i$	$\cos 105 \pm i\sin 105$	$-1/4(\sqrt{6-\sqrt{2}}) \pm i(\sqrt{6+\sqrt{2}})$
$\cos 120 \pm i\sin 120$	$-1/2 \pm i\sqrt{3}/2$	$\cos 135 \pm i\sin 135$	$-\sqrt{2}/2 \pm i\sqrt{2}/2$
$\cos 150 \pm i\sin 150$	$-\sqrt{3}/2 \pm i/2$	$\cos 165 \pm i\sin 165$	$-1/4(\sqrt{6+\sqrt{2}}) \pm i/4(\sqrt{6-\sqrt{2}})$
$\cos 180 \pm i\sin 180$	-1		

These are the 12th roots of any quantity:  $a = 12\text{th root of } 1 \therefore a^{-12}\sqrt{m}$  is 12th root of  $m$ . It follows that  $a$  and  $b$  are not sine and cosine to the same angle unless  $a^2 + b^2 = 1$ . But  $a$  and  $b$  can be **proportional** to the sine and cosine of that same angle. For if  $a^2 + b^2 = m^2$  then  $a/m, b/m$  are cosine and sine to that angle and the tangent of that angle is  $b/a$ . From this we derive an important transformation:

$$a + ib = (a^2 + b^2)^{1/2} (\cos \tan^{-1}b/a + i\sin \tan^{-1}b/a) = (a^2 + b^2)^{\epsilon} \epsilon^{\wedge} (\tan^{-1}i b/a)$$

where  $x^{\wedge}y$  is notation for  $x^y$  and we raise  $(a^2+b^2)$  to  $\epsilon$  to the  $(\tan^{-1}i b/a)$ . The function  $\tan^{-1}$  has two values in opposite directions,  $\theta$  and  $\theta+\pi$ . So if using the positive value of  $(a^2 + b^2)^{1/2}$  then the value of  $\tan^{-1}b/a$  is the one whose angle has the same cosine as  $a$ .

We can create a basis for trig using  $z = \epsilon^{i\theta} = \cos\theta + i\sin\theta$ :

$z = \cos\theta + i\sin\theta$	$z^n = \cos(n\theta) + i\sin(n\theta)$
$z^{-1} = \cos\theta - i\sin\theta$	$z^{-n} = \cos(n\theta) - i\sin(n\theta)$
$2\cos\theta = z + z^{-1}$	$2\cos(n\theta) = z^n + z^{-n}$
$2i\sin\theta = z - z^{-1}$	$2i\sin(n\theta) = z^n - z^{-n}$

From this we can derive some of our prior results:

- 1)  $\sin^3\theta = (1/2i)^3(z - z^{-1})^3 = -1/8i(z^3 - 3z + 3z^{-1} - z^{-3}) = -1/4(\sin 3\theta - 3\sin\theta)$
- 2)  $\cos^4\theta = (z^4 + z^{-4})/2 = ((c + is)^4 + (c - is)^4)/2 = c^4 - 6c^2s^2 + s^4$

All of these numbers of the form  $a + bi$  are **complex numbers** denoted **C** where

$$\mathbf{C} = \{ a + bi \text{ for } \forall a, b \in \mathbf{R} \}$$

The second half of De Morgan's later trig text was an early (the first?) algebra of complex number called **double algebra** and developed its own complex arithmetic. While everything there is still valid, we will take the slightly more modern view of this arithmetic in the pages that follow.

As in analytic geometry, we use two perpendicular axes, here with origin A. Take any line segment AB as the unit length. Here, AB is a **vector** which is a **directed line segment**, a length pointing in a definite direction. If we put the arrow on A, we would have vector  $BA = -1$ .

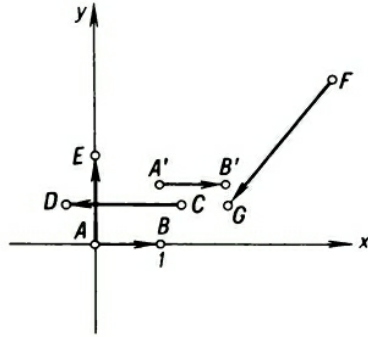

Any vector on or parallel to the x-axis can be measured by AB and represent some real number  $r \in \mathbf{R}$ . The x-axis is referred to as the **real axis**.  $CD = -2$ .  $A'B' = 1$ . Vectors not on or parallel to the real axis do not represent real numbers. They represent complex numbers, partially or totally **imaginary**. Any vectors which are equal in length and parallel to e.o. represent the same number. Complex numbers are **compound** numbers, part real and part imaginary. Imaginary is another poorly chosen label coming from  $\sqrt{-1}$  which was "imaginary" and gives us the notation **i**.

Let  $AB_1, AB_2$  be two vectors representing  $c_1, c_2 \in \mathbf{C}$ . Then to derive  $c_1+c_2$ , we create  $B_1C \parallel AB_2$  and  $B_2C \parallel AB_1$  and these intersect at C. Then the vector  $AC = c_1+c_2$ . Going both ways from A to C proves that  $c_1+c_2 = c_2+c_1$  and we have the Commutative Law.

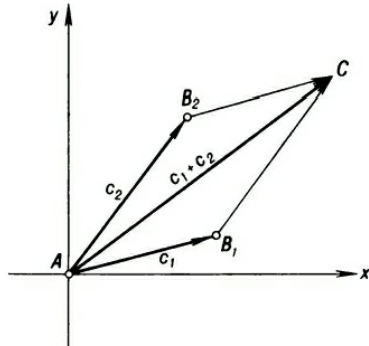

If to this we add any  $c_3$  we can show

$$(c_1+c_2)+c_3 = AC+c_3 = c_1+B_1D = c_1+(c_2+c_3)$$

and have the Associative Law.

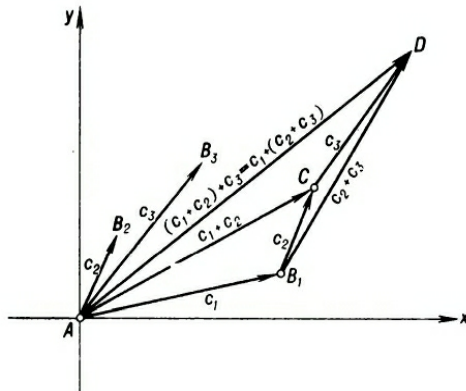

Complex numbers have absolute values and arguments. Let  $AC$  represent some  $c \in \mathbf{C}$ . Its absolute value is its undirected length and its arg is its angle wrt the positive x-axis. Just as angles in trig can be taken positively and negatively, these can be taken in either direction and as any multiple of  $n \cdot 2\pi$ ,  $n \in \mathbf{Z}$ . We denote abs.val. and arg of vector  $c$  as  $|c|$  and  $\arg c$ . If  $c \in \mathbf{R}$ , its arg is either 0 or  $\pm\pi$ .

Here,  $|c| = |c_1| = 1$ ,  $|c_2| = \sqrt{2}$ ,  $|c_3| = 2$

$\arg c = 0$        $\arg c_1 = \pi/2$   
 $\arg c_3 = \pi/4$     $\arg c_4 = -\pi/3$

$c_1$  is  $0 + i$ ,  $i$  is the vertical unit vector of length 1.

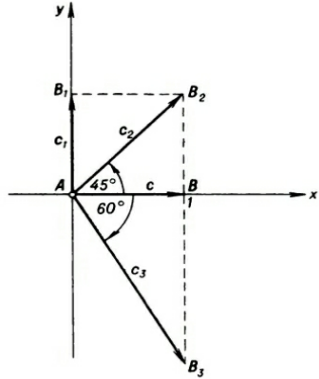

To multiply  $c_1 \cdot c_2$ , we multiply the absolute values  $|c_1| \cdot |c_2|$  and add  $\arg c_1 + \arg c_2$  or

$$|c_1| \cdot |c_2| = 1 \cdot \sqrt{2} = \sqrt{2}$$

$$\arg c_1 + \arg c_2 = \pi/2 + \pi/4 = 3\pi/4$$

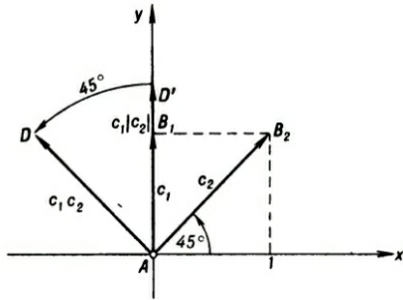

In  $c_2 \cdot c_3$ ,  $c_3$  is negative.

$$\text{So } \arg c_2 \cdot c_3 = \pi/4 - \pi/3 = -\pi/12$$

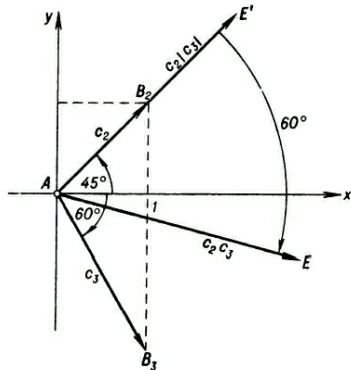

You can see that in these instances of addition and multiplication that the Commutative and Associative Laws hold because they already hold in arithmetic and we have added nothing new. We have conformed the new to the existing freedoms.

Let's prove the Distributive Law:  $(c_1 + c_2)c_3 = c_1c_3 + c_2c_3$

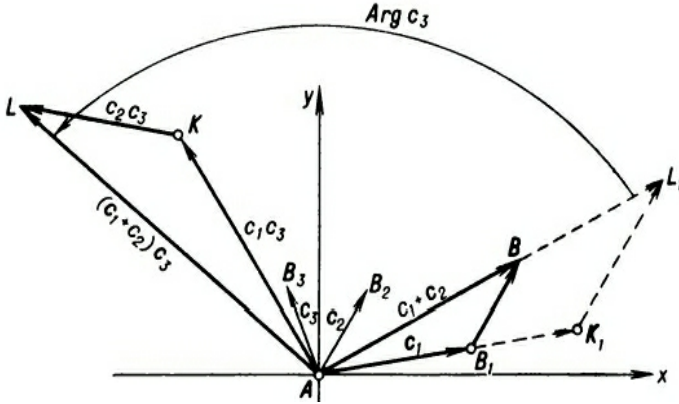

Vector  $AB = c_1 + c_2$ . Multiply  $\Delta BAB_1$  by  $c_3$  and we have  $\Delta L_1AK_1$   
 $AK_1 = |c_1||c_3|$   $L_1K_1 = |c_2||c_3|$   $AL_1 = |c_1 + c_2||c_3|$   
 Rotating  $\Delta L_1AK_1$  through  $\arg c_3$  we have  $\Delta LAK$   
 $AK = c_1c_3$   $KL = c_2c_3$   $AL = (c_1 + c_2)c_3$   
 Using complex addition we see  $c_1c_3 + c_2c_3 = (c_1 + c_2)c_3$  ■

Subtraction is the inverse of addition or  
 if  $c_1 + c_2 = c_3$   
 then  $c_1 - c_2 = d$

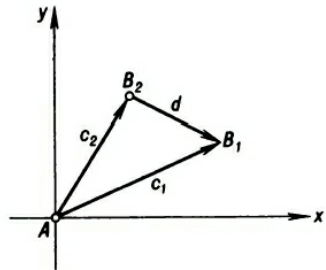

Sym. for division, if  $c_1 = c_2r$  then  $r = c_1/c_2$ .

In both of these cases, the form of + and  $\times$  is used to create their own inverses. So if one is consistent, its inverse is consistent, too.

So  $|r| = |c_1| \div |c_2|$  and  $\arg r = \angle B_2AB$  in the direction from  $AB_2$  to  $AB_1$  which in this case is negative.

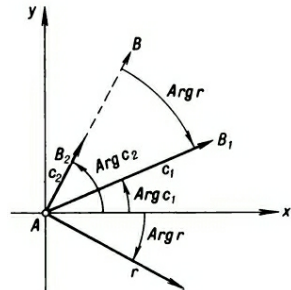

In division, if  $c_1 \parallel c_2$  in same direction then  $\angle B_2AB_1 = 0 = \arg r$ . If  $c_1 \parallel c_2$  and they are in opposite directions,  $\angle B_2AB_1 = \pi$  and  $r$  is negative. Because complex arithmetic is consistent with real arithmetic, they both spring from the same truth-grounds under the same freedoms of number:

$$\begin{aligned} (c_1 + c_2)(c_1 - c_2) &= c_1^2 - c_2^2 \\ (c_1 + c_2)^2 &= c_1^2 + 2c_1c_2 + c_2^2 \\ c_1/c_2 + c_3/c_4 &= (c_1c_4 + c_2c_3)/c_2c_4 \end{aligned}$$

But all of these express a different form of the same truth that the reals express. In algebra,  $i$  or  $\sqrt{-1}$  arose from forms like  $x^2 + x + 1$  with roots of  $(-1 \pm \sqrt{-3})/2$ . The same idea arises from a different form of number in the complex plane. We want to show that  $c^2 = -1$  or  $c = \sqrt{-1}$ .

$c \cdot c = |c||c|$  with  $\arg c + \arg c$ . So if  $|c^2| = 1$  then  $|c| = 1$ . Our  $\arg = 2 \cdot \arg c$  and  $c_2 = -1 \in \mathbf{R}$ . So  $2 \cdot \arg c = \pm\pi \therefore \arg c = \pm\pi/2$ .

Here,  $AC$  and  $AC'$  represent this  $c$  of  $|c|=1$  and  $\arg c = \pm\pi/2$ . We denote  $c$  as  $i$  and have  $+i$  with  $\arg \pi/2$  and  $-i$  is  $-i$  with  $\arg -\pi/2$ . We call this "i" imaginary as an unfortunate remnant of the idealistic metaphysics in the minds of the mathematicians who brought  $i$  into the fold of number.

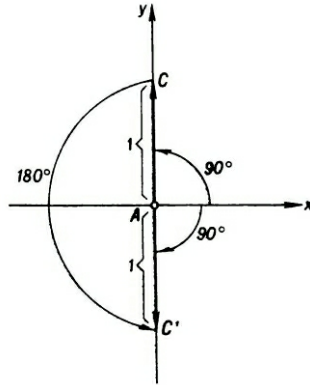

Think of  $\pm 1$  as the real unit vectors, positive and negative and  $\pm i$  as the imaginary unit vectors, positive and negative. If we have a vertical vector, its direction determines whether it is a multiple of  $i$  or  $-i$ .

Let  $A'E'$  be a vector not parallel to the axes. Using geometry, we can define  $c = A'E'$  by the absolute values of vectors  $a$  and  $bi$  and here we arrive back at the idea of  $a + bi$ .

Recall that all parallel vectors represent the same number. So all vectors equal some vector  $AB$  where  $A$  is the origin and  $AB$  is parallel to the vector in question. If  $AB$  is  $a + bi$ , then all points on this complex plane take their values from these vectors on the origin. Then  $a+bi$  defines point  $(a,b)$  in the complex plane and the point and the vector are viewed as equivalent.

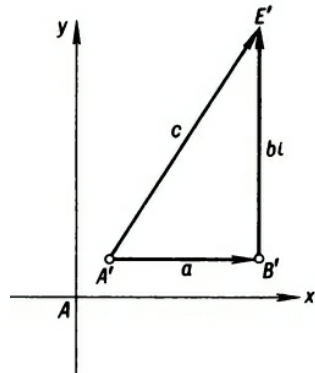

These ideas are the basis of Vector Calculus and Complex Analysis. Let's look at three more ideas which are fundamental in the complex plane.

It is usual to denote complex values as  $z$  just as we use  $x$  for real values.  $\forall z \in \mathbf{C}$ , we can add some  $a \in \mathbf{C}$ :  $z' = z + a$ . Viewing these as points but maintaining vector addition, we then have the **translation** of  $z$  by  $a$  to  $z'$ .

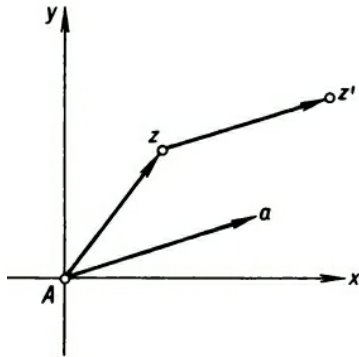

It is clear that you can use this to translate any  $z \in \mathbf{C}$  to  $\forall z' \in \mathbf{C}$  by choosing the right  $a$ . And as a function, this idea could be used to translate any domain of points to any range of points in the complex plane.

The idea of a complex function with geometric consequences can be applied to complex multiplication. If  $z$  is vector  $AE$  then  $zc = |z||c| = AE_1$  and then  $\arg z + \arg c$  gives the vector  $AE$  **stretched**  $|c|$  times in a new position. If  $c \in \mathbf{R}$ , there would be no rotation.

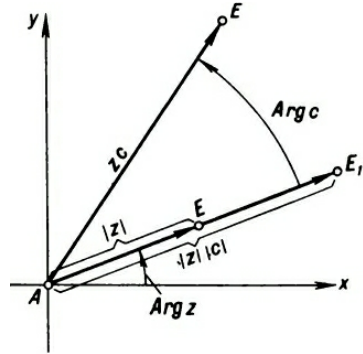

If  $|c| > 1$ , the new  $AE$  would be longer. If  $|c| < 1$ , it would be shorter. and if  $|c| = 1$  the length of the new vector is unchanged. So multiplication by  $c \in \mathbf{R}$  is a stretching of any vectors in the domain of such a function. And if  $c \in \mathbf{C}$  and  $|c| = 1$ , then all vectors in the domain are simply rotated.

If we wanted of rotate  $z = AE$  by  $\pi/2$  we multiply  $z$  by  $i$ . To rotate  $z$  by  $-\pi/4$  or  $-45^\circ$ , we can calculate our rotation by using  $AC = 1$  at  $-45^\circ$  from the  $x$ -axis. Then by Euclid 1.47, the triangles sides are  $\sqrt{2}/2$ . so we need  $c = \sqrt{2}/2 - i\sqrt{2}/2$  to maintain  $|z|$  and rotate it through  $-\pi/4$ .

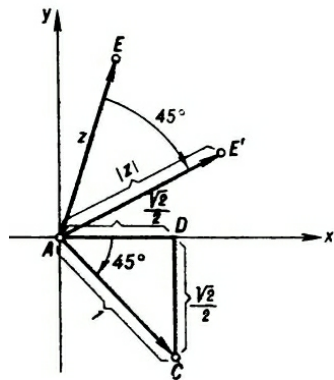

This emphasizes that the vector length is the length of the hypotenuse of a triangle of sides  $a$  and  $b$ :

$$(\sqrt{2}/2)^2 + (-\sqrt{2}/2)^2 = 2/4 + 2/4 = 1^2 \therefore |c| = 1$$



### Hyperbolic Trigonometry

Let's think about another context where a "trigonometry" arises with its own forms of sines and cosines. Our unit circle is  $x^2 + y^2 = 1$  and the circle is a special case of an ellipse which itself is a conic section. A corresponding case of a conic section to the circle is the equilateral hyperbola of  $x^2 - y^2 = 1$ .

If you will lean slightly to the right, this equilateral hyperbola will be just fine. In an equilateral hyperbola, the asymptotes, which the curves infinitely approach, are at right angles at origin O.

$\forall P, PK \perp DK, OK = v, KP = w$   
 Then  $x = v \cdot \cos 45^\circ + w \cdot \cos 45^\circ$   
 $= \sqrt{2}/2(v + w)$   
 and  $y = v \cdot \sin 45^\circ + w \cdot \sin 45^\circ$   
 $= \sqrt{2}/2(v - w)$   
 $\therefore \frac{1}{2}(v+w)^2 - \frac{1}{2}(v-w)^2 = 1 = 2vw.$

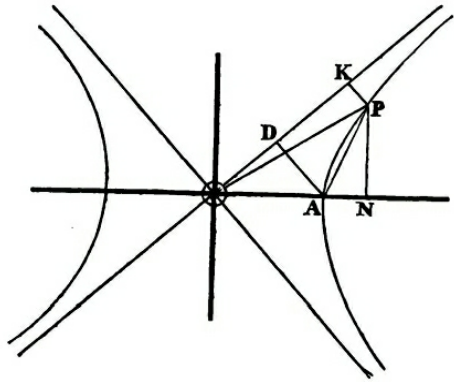

If  $AQ'$  is the curve and  $OL'$  is the asymptote, we can drop perpendiculars:  $OK:KL::OK':K'L'$   
 Divide  $KL$  and  $K'L'$  into  $n$  equal parts.  
 $OK = v, KP = w, KL = t$ . Then each part is  $t/n$  and the  $m$ th part ends at  $v + (mt)/n$  from center O and the

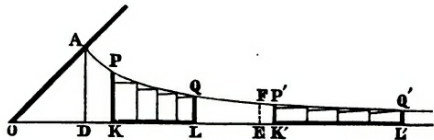

altitude of the  $m$ th rectangle is  $1 \div 2(v + mt/n)$  and its area (work this out) is  $1 \div 2((nv)/t + m)$ . But in the second group, the area  $v/t$  is the same as the first group and it follows that the sum of the rectangles on  $KL$  equals the sum of the rectangles on  $K'L'$ .

The figure  $KPQL$  is composed of rectangles and curvilinear triangles. The sum of these latter is less than any of the rectangles's bases with an altitude of  $KP - LQ$ . As  $n \rightarrow \infty$ , the sum of the triangles  $\rightarrow 0$ . Or the current curvilinear area is the limit of the sum of the rectangles. As  $KPQL = K'P'Q'L'$ , their curvilinear areas are equal. Therefore area  $KPQL$  depends only on  $OL:OK$ .

Let  $OK = v$ , area  $ADPK = A$  and  $v = \phi A$ . Take  $QLEF = A$ . Let  $ADLQ = B$  then  $ADEF = A + B$ . Because  $ADKP = QLEF$  then  $OD:OK::OL:OE$ . Let  $OD = m$ . Then  $m:\phi A::\phi B:\phi(A+B)$  or

$$\phi(A+B)/m = \phi A/m \cdot \phi B/m \text{ or } \phi A = mc^A$$

This last comes from our  $\varphi(xy) = (\varphi x)^y$  in the algebra section  $\therefore v = c^A$  where we need a definite c.  $OA = 1, \angle AOD = 45^\circ \therefore m = \sqrt{2}/2 \therefore$

$$A = (\ln v - \ln \sqrt{2}/2) \div \log c \quad (\text{from } v = c^A)$$

To determine c, if we increase v by h, the increase of area consists of a rectangle and a curvilinear triangle. As  $h \rightarrow 0$  the ratio of  $\text{curv.}\Delta:\text{rectangles} \rightarrow 0$  and therefore has a limit of unity. The increase of area is:

$$\frac{\ln(v+h) - \ln(\sqrt{2}/2)}{\ln(c)} - \frac{\ln(v) - \ln(\sqrt{2}/2)}{\ln(c)} = 1/\ln(c) \cdot \ln(1 + h/v)$$

So the area of the rectangle is  $h \cdot 1/(2(v+h))$  and the ratio is

$$(2(v+h))/h \cdot (1/\ln(c)) \cdot (h/v - h^2/2v^2 + \dots)$$

And the limit of this ratio is  $2 \div \ln(c)$ .

By the above  $2/\ln(c) = 1 \therefore c = 2$  and  $A = \frac{1}{2}\ln(\sqrt{2} \cdot v)$ .

Now we find the curvilinear area APN.

$$\begin{aligned} \text{DKPNA} &= \text{DKPA} + \text{APN} \\ &= \frac{1}{2}\text{DK}(\text{DA} + \text{KP}) + \frac{1}{2}\text{AN} \cdot \text{PN} \\ &= \frac{1}{2}(v - \sqrt{2}/2)(\sqrt{2}/2 + w) + \frac{1}{2}(x - 1)y \\ &= \frac{1}{2}vw + \sqrt{2}/4 \cdot (v-w) - \frac{1}{4} + \frac{1}{2}xy - \frac{1}{2}y \\ &= \frac{1}{2}xy \quad (\text{since } 2vw=1, \sqrt{2}/2(v-w) = y) \\ \therefore \text{ONP} &= \text{DKPNA} \therefore \text{APO} = \text{DKPA} \\ \therefore \text{areaAPO} &= \text{areaDKPA} = \frac{1}{2}\ln(\sqrt{2} \cdot v) = \frac{1}{2}\ln(x+y) = \frac{1}{2}\ln(x + \sqrt{x^2-1}) = S \\ \therefore x + y &= \epsilon^{2S} \quad x - y = \epsilon^{-2S} \quad x = (\epsilon^{2Si} + \epsilon^{-2Si})/2 \quad y = (\epsilon^{2Si} - \epsilon^{-2Si})/2 \end{aligned}$$

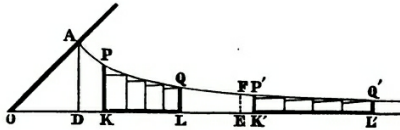

Go back to our unit circle. If  $S = \text{area of a sector with angle } \theta \text{ and } r = 1$  then  $S = \theta(1)^2/2$  or  $\theta = 2S$ . But  $x = \cos\theta$  and  $y = \sin\theta \therefore x = (\epsilon^{2Si} + \epsilon^{-2Si})/2 \quad y = (\epsilon^{2Si} - \epsilon^{-2Si})/2$

If, in an equilateral hyperbola, we call the numbers  $x,y$  the hyperbolic cosine and sine of the number of square units in twice the sectorial area, we have  $\theta = 2S$ , where  $\theta$  is not derived from an angle. Then using capital letters to denote hyperbolic fns:

$$\text{Cos}\theta = (\epsilon^\theta + \epsilon^{-\theta})/2 \quad \text{Sin}\theta = (\epsilon^\theta - \epsilon^{-\theta})/2 \quad \text{Tan}\theta = (\epsilon^\theta - \epsilon^{-\theta})/(\epsilon^\theta + \epsilon^{-\theta})$$

So to convert a circular trig form to hyperbolic, when no inverse fns are involved, we change  $\cos\theta$  to  $\text{Cos}\theta$  and  $\sin\theta$  to  $i \cdot \text{Sin}\theta$ . This gives us:

$$\begin{aligned} \text{Cos}^2\theta - \text{Sin}^2\theta &= 1 & \text{Cos}(\varphi \pm \theta) &= \text{Cos}\varphi\text{Cos}\theta \pm \text{Sin}\varphi\text{Sin}\theta \\ \text{Cos}^2\theta + \text{Sin}^2\theta &= \text{Cos}2\theta & \text{Sin}(\varphi \pm \theta) &= \text{Sin}\varphi\text{Cos}\theta \pm \text{Cos}\varphi\text{Sin}\theta \\ \text{Cos}^n\theta &= 1/2^{n-1}(\text{Cosn}\theta + n\text{Cos}(n-2)\theta + n \cdot (n-1)/2 \cdot \text{Cos}(n-4)\theta + \dots) \\ \text{Sin}^n\theta &= 1/2^{n-1}(\text{Cosn}\theta + n\text{Cos}(n-2)\theta + \dots) \quad n \text{ even} \\ \text{Sin}^n\theta &= 1/2^{n-1}(\text{Sinn}\theta + n\text{Sin}(n-2)\theta + \dots) \quad n \text{ odd} \end{aligned}$$

If we take  $x = (a^\theta + a^{-\theta})/2$  and  $y = (a^\theta - a^{-\theta})/2$  and assume  $x^2 + y^2 = 1$ , all of trigonometry follows if we call  $x$  cosine and  $y$  sine. And we find the inverse functions depend upon how we define  $a$ . If  $a$  is defined as  $\epsilon^i$  we regain the application of angular revolution.

### Solution of Triangles

Fasten your seatbelts. Here comes the rough guide to everything you need to know about using trig to solve triangles. Triangles have three sides and three angles or six parts and if you have any three (except three angles) you can solve for the other three. To see why three angles won't work, draw any triangle (right now). Join the sides with a line parallel to the base. The new inner triangle has the same angles as the original. You can extend the sides, add another line parallel to the base and the new bigger triangle has the same angles. All triangles with the same angles are **similar** or **proportional**.

Trig, as the solution of triangles, was originally *a distinct branch of mathematics, but is now of little importance in a general course of mathematics*. But it won't hurt you to solve a triangle. Older trig texts with their problems as examples of how to survey land where the terrain is impassable are pretty entertaining.

Let the sides of a triangle be  $a, b, c$  and let the angles opposite these sides be  $\angle A, \angle B, \angle C$ . Let  $C$  be a right angle ( $\perp$ ) then  $c$  is the hypotenuse.

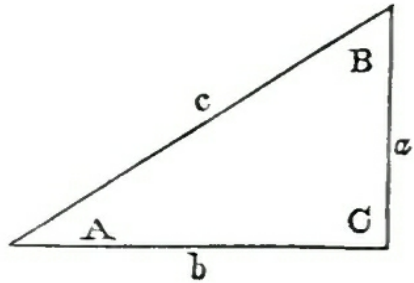

$$\begin{aligned} a/c &= \sin A = \cos B & a &= c \cdot \sin A = c \cdot \cos B \\ a/b &= \tan A = \cot B & a &= b \cdot \tan A = b \cdot \cot B \\ c^2 &= a^2 + b^2 & b &= \sqrt{(c-a)(c+a)} \end{aligned}$$

If you think you understand this, do  $b/c$  symmetrically to  $a/c$  and  $a$  symmetrically to the last identity  $b$ . The angles of  $\triangle BAC$  sum to  $2\perp$  or  $180^\circ \therefore$  if  $\angle C = 90^\circ$  and you have  $\angle B$  then  $\angle A = \angle C - \angle B$ . So we can solve **all** right triangles with this table:

<b>Given</b>			
$a, b$	$\tan B = \frac{b}{a},$	$c = \frac{b}{\sin B} = \frac{a}{\cos B},$	$A = 90^\circ - B.$
$c, b$	$a = \sqrt{(c-b)(c+b)},$	$\sin B = \frac{b}{c},$	$A = 90^\circ - B.$
$c, A$	$b = c \cos A,$	$a = c \sin A,$	$B = 90^\circ - A.$
$a, A$	$b = a \cot A,$	$c = \frac{a}{\sin A},$	$B = 90^\circ - A.$
$b, A$	$a = b \tan A,$	$c = \frac{b}{\cos A},$	$B = 90^\circ - A.$

In De Morgan's day the values of trig fns came from trig tables with values five or more digits long. Logarithms were used to calculate the values and the whole thing was an arithmetic grind beyond the limits of your average modern patience. So they used shortcuts when they could. For small  $\angle A$ , when given  $b$  and  $\angle A$ ,  $c = b/\cos A$  was not a **convenient** computation.

Given what you know of "real" trigonometry, why can we rely on this shortcut:

$$c - b = (b \cdot (1 - \cos A)) / \cos A \cong 2b \cdot \sin^2(A/2)?$$

That does it for right triangles. Now draw any triangle (i.e. not a right triangle). Draw a line perpendicular from  $\angle C$  to side  $c$ . If the perpendicular is inside the triangle, you can use the definition of sine to see the perpendicular is  $b \cdot \sin A = a \cdot \sin B$ . If it falls outside the triangle, then we use the external angles of  $\angle A, B$  and have the same sine. So in all cases,  $a \cdot \sin B = b \cdot \sin A$  or  $a / \sin A = b / \sin B$  or  $a : b : \sin A : \sin B$ . The **Law of Sines** follows:

$$a / \sin A = b / \sin B = c / \sin C \quad [1]$$

And that was the sweetest and shortest proof of this you will ever find. This law is often used in solving triangles. If you take the expansion of  $\sin(A+B)$ , square both sides, and express  $\cos^2$  in terms of  $\sin^2$ , we have:

$$\begin{aligned} \sin^2(A+B) &= \sin^2 A (1 - \sin^2 B) + (1 - \sin^2 A) \sin^2 B + 2 \sin A \cdot \sin B \cdot \cos A \cdot \cos B \\ &= \sin^2 A + \sin^2 B + 2 \sin A \cdot \sin B \cdot \cos(A+B) \end{aligned}$$

If  $\angle A, B, C$  are the angles of your triangle:

$$\angle A + \angle B = 180^\circ - \angle C \quad \sin(A+B) = \sin C \quad \cos(A+B) = -\cos C$$

$$\therefore \sin^2 C = \sin^2 A + \sin^2 B - 2 \sin A \cdot \sin B \cdot \cos C$$

Divide by  $\sin^2 C$ , for  $\sin A / \sin C$  and  $\sin B / \sin C$  sub  $a/c$ ,  $b/c$ , multiply by  $c^2$  and

$$c^2 = a^2 + b^2 - 2ab \cdot \cos C \quad [2]$$

This is the **Law of Cosines**. Obedient children can show that this is the equivalent of Euclid 2.12,13 and that the introduction of negative number would combine his two propositions. Using inverse fns, [2] is equivalent to

$$\begin{aligned} c &= (a + b) \cos \sin^{-1} \left( \frac{2\sqrt{ab} \cdot \cos(c/2)}{(a + b)} \right) \quad [3] \\ &= (a - b) \sec \tan^{-1} \left( \frac{2\sqrt{ab} \cdot \sin(c/2)}{(a - b)} \right) \end{aligned}$$

From your diagram with the perpendicular from  $\angle C$  to  $c$ , each side of a triangle is the sum of the projections of the other two upon it, positive or negative as the angle of projection is acute or obtuse. Therefore:

$$a = b \cdot \cos C + c \cdot \cos B \quad b = c \cdot \cos A + a \cdot \cos C \quad c = a \cdot \cos B + b \cdot \cos A$$

This makes  $c^2 = (c \cdot \cos A)^2 + (c \cdot \sin A)^2 = (b - a \cdot \cos C)^2 + (a \cdot \sin C)^2 = b^2 - 2ab \cdot \cos C + a^2 \therefore$

$$\cos C = (a^2 + b^2 - c^2) / 2ab \quad [4]$$

Sym. for  $\cos A$  and  $\cos B$ . It follows (and you should verify that it does follow):

$$\begin{aligned} 1 + \cos C &= ((a + b)^2 - c^2) / 2ab & 1 - \cos C &= (c^2 - (a + b)^2) / 2ab \\ \cos^2(c/2) &= ((a+b+c)(a+b-c)) / 4ab & \sin^2(c/2) &= ((b+c-a)(c+a-b)) / 4ab \end{aligned}$$

If you've been dozing, wake up. This next bit about the perimeter of a triangle equaling  $2s$  will pop up in the future when you least expect it.



# Calculus

## Analytical Geometry

Leave your seatbelt on. I have shared all of De Morgan's analytic geometry with you that was in the *Elements* series. But in Calculus, it would be good to know a bit more. When you deal with polynomials of degree three and higher, they are usually treated abstractly. But second degree equations, beyond quadratics, are easily identified geometric forms. So this will be a rough guide to the general second degree equation:

$$ax^2 + bxy + cy^2 + dx + ey + f = 0$$

Every form this eqn takes is a **conic section** or the intersection of a plane with a cone of two sheets. We should first note that if we have the dx, ey, or bxy terms, we can simplify the eqn, ditch these terms, and then "unsimplify" our results, if necessary.

If  $b^2 - 4ac \neq 0$ , our conic section is centered somewhere away from the origin, out in the plane. So we can **translate** it to the origin and lose the dx, ey terms.

If we have a bxy term, our curve has been rotated. If we unrotate it, we lose that term as well. In both these cases, I will leave the details to the curious reader.

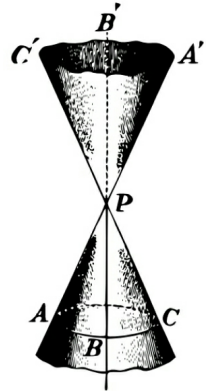

Now look at the double cone and imagine our passing a plane through it.

<b><math>b^2 - 4ac</math></b>	<b>intersection is</b>
< 0	ellipse, circle, or point
> 0	hyperbola or two intersecting lines
= 0	parabola, two parallel lines, one line

If the plane cuts only one sheet of the cone, you get a circle if your plane is perpendicular to the cone's vertical axis BB'. Hold the plane at an angle and you get an ellipse. Pass the cone through where the sheets come together and you get a point. You can work out the intersections of the hyperbola, parabola, and their extreme cases on your own. To help with that, let's take a brief overview of the conic sections. We look at them all as unrotated and centered on the origin of the X and Y axes.

An ellipse has two **foci**: F,F' and is composed of all points P:  $PF+PF' = 2a$  where a is some constant. Here AA' is the **major axis** and BB' is the **minor axis**. C is the origin and  $CF=CF'$ .  $BC = b$ . By letting  $CR = x$  and  $RP = y$  for  $\forall P$ , we derive the eqn of the ellipse:

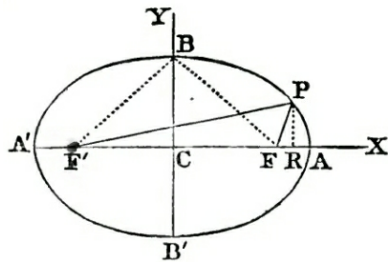

$$\frac{x^2}{a^2} + \frac{y^2}{b^2} = 1 \quad \text{or} \quad y^2 = \frac{b^2}{a^2}(a^2 - x^2)$$

If you have been actively developing your mind with this text, you will have no trouble understanding the derivation of the ellipse's equation. You can probably figure out how to translate the general 2nd degree equation if you substitute  $x + h$  for  $x$  and  $y + k$  for  $y$ . Rotation requires a bit of trigonometry. But you might be able to do that as well. Do your best and then go find the answer somewhere if you attempt these.

In an hyperbola, we have  $|PF - PF'| = 2a$ . The line  $XX'$ , produced both ways, is the **transverse axis**.  $BB'$  is the **conjugate axis** and  $BB' = 2b$ . Then the eqn for an hyperbola becomes:

$$\frac{x^2}{a^2} - \frac{y^2}{b^2} = 1 \text{ or } y^2 = \frac{b^2}{a^2}(x^2 - a^2)$$

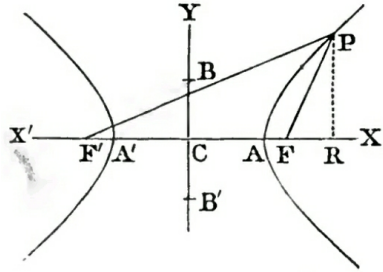

In a parabola, we have only one focus F. The line  $YY'$  is the **directrix**. The parabola is all points P where PD (which is perpendicular to  $YY'$ ) equals PF. Let's do this derivation:

BN = x. PN = y. BF = 2a. By definition, FP = PD.  
 $\therefore FP = BN$  (DPNB  $\equiv$  square)  $\therefore FP^2 = BN^2$   
 $\therefore FN^2 + PN^2 = BN^2$  (Euclid 1.47)  
 $\therefore (x - 2a)^2 + y^2 = x^2 \therefore y^2 = 4a(x - a)$

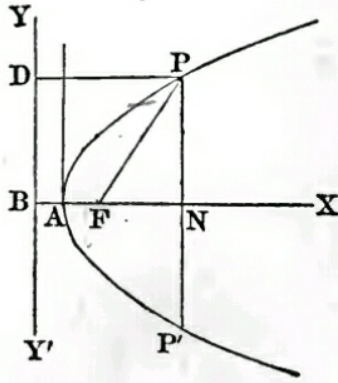

Usually, origin is at A. Let  $x = x' + a$   $y = y'$ .  
 By substitution,  $y'^2 = 4ax'$   
 Lose the accents for the gen.eqn:  $y^2 = 4ax$

Now you can recognise these forms of number when you encounter them by quickly calculating the  $b^2 - 4ac$ . Then you can picture to yourself what you are dealing with. Let's look at solving systems of such eqns for their intersections.

1)  
 $x^2 + 2xy + y^2 + 2x + 2y - 120 = 0$  [1]  
 $xy - y^2 - 8 = 0$  [2]  
 Use the  $b^2 - 4ac$  to identify these. Given what they are, in what forms can they intersect? Don't forget single-point intersections which are tangents.  
 $(x + y)^2 + 2(x + y) = 120$  (from 1)  
 $(x + y)^2 + 2(x + y) + 1 = 121$  (completing the square)  
 $\therefore (x + y) + 1 = \pm 11 \therefore (x + y) = 10, -12$   
 Let  $x + y = 10$  [3]                      Let  $x + y = -12$   
 $x - y = 8/y$  (2)                      Sym. from  $x - y = 8/y$  w/ $x = -12$   
 $2y = 10 - 8/y$  (3 - 2)                       $\therefore y^2 + 6y + 4 = 0$   
 $\therefore y^2 = 5y - 4$                        $\therefore y = -3 \pm \sqrt{5}$   
 $\therefore y^2 - 5y + 4 = 0$                        $\therefore x = -12 - y = -9 \mp \sqrt{5}$   
 $\therefore y = 4, 1$                       solns  $(-9 - \sqrt{5}, -3 + \sqrt{5})$   $(-9 + \sqrt{5}, -3 - \sqrt{5})$   
 $\therefore x = 10 - y = 6, 9$  solns (6,4) (9,1)

Learn to keep track of  $\pm$  and  $\sqrt{\phantom{x}}$  which is usually  $\pm$  upside-down. They have a discernible logic to their use.

2)

$$x^2 + y^2 - x - y - 78 = 0 \quad [1]$$

$$xy + x + y - 39 = 0 \quad [2]$$

Identify these and resist the urge to translate and rotate [2] out of existence. So what is [2]? And what is this apparent "nonexistence" if we center it on the origin? What does this **mean**?

$$x^2 + y^2 - (x + y) = 78 \quad (1)$$

$$2xy + 2(x + y) = 78 \quad (2 \times [2])$$

$$x^2 + 2xy + y^2 + x + y - 156 = 0 \quad (+)$$

$$(x + y)^2 + (x + y) - 156 = 0$$

$$\therefore (x + y) = 12, -13$$

$$\text{Let } x + y = 12$$

$$xy = 39 - (x + y) = 39 - 12 = 27 \quad (2)$$

$$x^2 + y^2 = 78 + (x + y) = 78 + 12 = 90 \quad (1)$$

$$2xy = 54$$

$$\therefore x^2 - 2xy + y^2 = 36 \quad (-)$$

$$\therefore (x - y) = \pm 6 \quad [3]$$

$$(x + y) = 12 \quad [4]$$

$$\therefore 2x = 18, 6 \quad \therefore x = 9, 3 \quad (3 + 4)$$

$$\therefore 2y = 6, 18 \quad \therefore y = 3, 9 \quad (4 - 3)$$

solns (9,3) (3,9)

$$\text{Let } x + y = -13$$

$$\therefore xy = 39 + 13 = 52$$

$$x^2 + y^2 = 78 - 13 = 65$$

$$2xy = 104$$

$$\therefore x^2 - 2xy + y^2 = -39 \quad (\text{why?})$$

$$\therefore x - y = \pm\sqrt{-39} \text{ and } x + y = -13$$

$$\therefore 2x = -13 \pm \sqrt{-39} \quad 2y = -13 \mp \sqrt{-39} \quad (\text{how derived?})$$

$$\therefore x = (-13 \pm \sqrt{-39})/2 \quad y = (-13 \mp \sqrt{-39})/2$$

So what are the points of solution in this last half of the problem? On both problems, you should know the geometric forms of the eqns. And you know the points of intersection. How accurate a diagram can you sketch, given what you know?

I want to give you a glimpse of where the algebra you have learned so far will take you as you advance into an understanding of the general second degree equation.

$$ax^2 + bx + c = 0$$

$$ax^2 + bx + c + (b^2 - 4ac)/4a = a(x + b/2a)^2$$

$$ax^2 + bx + c = a \left( (x + b/2a)^2 - ((b^2 - 4ac)/4a^2) \right)$$

Verify those last two lines. It follows that

$$ax^2 + bxy + cy^2 = ay^2 \left( (x/y)^2 + b/a \cdot (x/y) + c/a \right)$$

$$= ay^2 \left( x/y + b/2a + \sqrt{((b^2 - 4ac)/4a^2)} \right) \cdot (x/y + b/2a - \sqrt{((b^2 - 4ac)/4a^2)})$$

$$= a \left( x + (b/2a + \sqrt{((b^2 - 4ac)/4a^2)})y \right) \cdot \left( x + (b/2a - \sqrt{((b^2 - 4ac)/4a^2)})y \right)$$



Verify that. From this it follows, that if

$$x^2 + 2x + 3 = (x + 1 + i\sqrt{2})(x + 1 - i\sqrt{2})$$

then

$$x^2 + 2xy + 3y = (x + (1 + i\sqrt{2})y)(x + (1 - i\sqrt{2})y)$$

So given  $x^3 + y^3 = (x + y)(x^2 - xy + y^2)$  We can resolve the RH factor into its own factors.  $x^2 - x + 1$  has roots  $1/2 \pm \sqrt{-3}/2$ . Therefore,

$$x^2 - xy + y^2 = (x + (1/2 + \sqrt{-3}/2)y)(x + (1/2 - \sqrt{-3}/2)y)$$

Our polynomial division also extends into this general second degree equation. A couple of examples and then an explanation.

$$\begin{array}{r} xy - x \ ) \ x^2 + xy + 1 \ ( \ 1 \\ \underline{xy - x} \phantom{+ 1} \\ x^2 + x + 1 \end{array}$$

No surprises there. We are just dividing normally. But we can go further, looking for factors:

$$\begin{array}{r} xy - 1 \ ) \ xy^2 - y^3 + x^2 - 1 \ ( \ y \\ \underline{xy^2 - y} \phantom{+ x^2 - 1} \\ y^2 - 1 \ ) \ -y^3 + x^2 + y - 1 \ ( \ -y \\ \underline{-y^3 + y} \phantom{+ x^2 - 1} \\ x^2 - 1 \end{array}$$

Here we have  $xy^2 - y^3 + x^2 - 1 = y(xy - 1) - y(y^2 - 1) + x^2 - 1$ , where  $x^2 - 1$  is the remainder. Note that if you divide by  $y^2 - 1$  first and then  $xy - 1$ , you get a different result. Now a bit of explanation. We **can** find factors here that would divide the dividend without remainder.

You can see that the dividend is not in the usual ordering. To get our factors, we have to introduce an ordering. And one might need to try more than one of the established orderings. And then one would need to follow an algorithm of repeated polynomial division to establish what is called a reduced Groebner Basis. And then we would have our "prime" little polynomials that would divide without remainder. And everything would be the same regardless of the order in which factors were used to divide the dividend.

If you look this up, the texts will run you neck deep through ring theory and try to scare you off with Hilbert's Basis Theorem of which one mathematician said, "This is not mathematics. This is religion." But I **could** lay all the practical steps out for you and you have all the knowledge you need to carry it out and find the factors. You can **do** these mathematics, without needing the theory, just as you can do arithmetic without its theory. Don't lose sight of the fact that *we learn mathematics by doing mathematics*. Mathematics, in the 20th century, has been running away from doing and clinging to theorizing. Don't let this put you off if you love doing mathematics. There is still a great deal to be done. And I think mathematics **needs us** to do it.

### Limits of Decreasing Ratios

Calculus is the study of ratios. Given a fn:  $y = f(x)$  then  $dx/dy$  is the ratio of

change in  $x$  : change in  $y$

If ratios change, it can happen that a ratio can **change towards equality**, Consider  $x:x+a$  and increase  $x$  by  $m$ :  $x+m:x+m+a$ . Note that their difference is still  $a$ .

$$\frac{x+a}{x} = 1 + \frac{a}{x} \quad \frac{x+m+a}{x+m} = 1 + \frac{a}{x+m} \quad \text{and} \quad \frac{a}{x} > \frac{a}{x+m}$$

$\therefore 1 < 1 + a/(x+m) < 1 + a/x$  and as  $m \rightarrow \infty$  then  $1 + a/(x+m) \rightarrow 1$ . Therefore the antecedent  $x$  is **approaching equality** with the consequent  $x+a$  in this ratio or as  $m \rightarrow \infty$  then  $x+m \rightarrow x+m+a$  because  $a$ , no matter how large, is finite.

Calculus is the study of motion. Imagine a circle with a chord on some arc. If we decrease the chord, its arc decreases without limit. But if we consider the ratio chord:arc we can't assume that as chord  $\rightarrow 0$  that the ratio will increase, decrease or remain the same.

Let  $M, N$  be two decreasing quantities:

$$\begin{array}{rcccccc} M & = & 1 & 1/20 & 1/400 & 1/8000 & 1/160000 \\ N & = & 1 & 1/2 & 1/4 & 1/8 & 1/16 \\ M/N & 1 & 10^{-1} & 10^{-2} & 10^{-3} & 10^{-4} & \end{array}$$

We can see that this ratio must decrease without limit. Sym.  $N:M$  increases without limit. Now redefine  $M, N$ :

$$\begin{array}{rcccccc} M & = & 1 & 1/3 & 1/6 & 1/10 & 1/15 & 1/21 & 1/28 \\ N & = & 1 & 1/4 & 1/9 & 1/16 & 1/25 & 1/36 & 1/49 \\ M/N & 1 & 4/3 & 9/6 & 16/10 & 25/15 & 36/21 & 49/28 & \end{array}$$

Here, ratio increases each step or each moment but the ratio has a limit:  $M/N \rightarrow 2$ . The denom of the  $x$ th term of  $M$  is  $1+2+3+\dots+x$  or  $x(x+1)/2 \therefore x$ th value of  $M = 2/(x(x+1))$  and the  $x$ th value of  $N = 1/x^2$ .

$$M/N = 2x^2/(x(x+1)) = 2x/(x+1) = 2 \cdot x/(x+1)$$

So as  $x \rightarrow \infty$  then  $x/(x+1) \rightarrow 1 \therefore M/N \rightarrow 2$ .  $M/N$  is in **increasing** ratio, limit 2.  $N/M$  is in **decreasing** ratio, limit  $1/2$ .

Here is an example of how, from time immemorial, idiots have written in books. Their idiotic artifacts may fade with time. But we see that, over a century on, their stupid and unhelpful marks remain to plague us. We need this diagram. But more importantly, we need you not to write in books. Use coloring books, if you must. But don't do this.

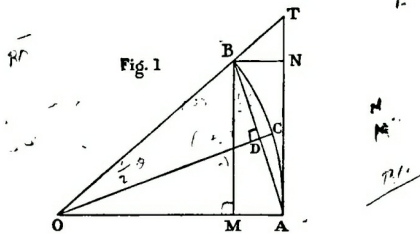

Here's a better copy of our diagram. Please don't mark on this one. This is part of  $\odot O, OC$  with arc  $AB$ . Radius  $OC$  bisects arc  $AB$  and chord  $AB$ .  $\triangle ODA \sim \triangle BMA$  (~ means "similar").

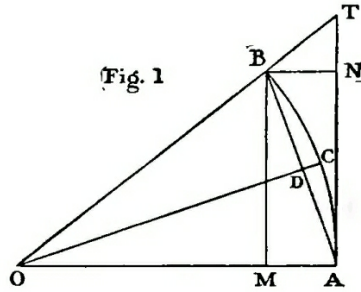

In Calculus, we don't (usually) move along the finite elements of a series. We move continuously. We let B move to A over every point in between. In this motion, chord  $BA$  and arc  $BA$ ; lines  $BM, MA, BT, TN$ ;  $\angle BOA, COA, MBA, TBN$  **all** must diminish without limit. Can you see that?

$OT$  diminishes and  $OM$  increases. But neither without limit.  $OT$  is never less and  $OM$  never greater than radius  $OC$ . The  $\angle OBM, MAB, BTN$  all increase but with a limit of  $\pi/2$ . Consider the ratios of these elements. We begin with chord  $AB < arcAB < BN+NA$ .  $\triangle BMA \sim \triangle ODA$  with sides always in same proportion (Euclid 6.4) even as sides  $\rightarrow 0$  while only one side of  $\triangle ODA$ :  $DA \rightarrow 0$ .

$OA$  and  $OD$  differ by  $DC$  so  $OD/OA \rightarrow 1$ . But  $OD/OA = BM/BA$ , so as  $B \rightarrow A$ ,  $BM \rightarrow BA$ . Because  $DA \rightarrow 0$ ,  $OD/DA$  and  $OA/DA \rightarrow \infty$ . These ratios equal  $BM/MA$  and  $BA/MA$  so  $BM, BA$  contain more and more multiples of  $MA$  without limit.

Because chord  $BA < arcBA < BN+NA = BM+MA$  then  $1 < arcBA/chdBA < BM/BA + MA/BA$  and as  $BM/BA \rightarrow 1$  then  $MA/BA \rightarrow 0$ . In practical terms here, if  $\angle BOA = 1^\circ$  then  $arcBA/chdBA = 1.00002$ . If  $\angle BOA = 1'$  then  $arcBA/chdBA = 1.0000001$ .

If  $m, n$  in  $m+n$  decrease together in such a way that  $n$  also decreases wrt  $m$ , Leibniz considered that  $n$  could be "infinitely small" wrt  $m$  so that  $m+n$  could be taken as  $m$ . We have made Calculus more rigorous. But this idea still lurks there down below.

Let's add a very small  $h$  to  $a$  and square the sum:

$$(a + h)^2 = a^2 + 2ah + h^2$$

where we have  $1 : h :: h : h^2$ . Here  $h^2 < 1$  and if  $mh = 1$  then  $mh^2 = h$  and  $m$  could be very large. Here, Leibniz could simply take  $2ah + h^2$  as  $2ah$ . But truly, "infinitely small" and "very large" are unfit terms for mathematics. They were already recognized as undesirable in De Morgan's day. But if we look at the increment of  $a$ , which is  $h$ , and the increment of  $a^2$ , which is  $2ah + h^2$ , we understand enough about limits to see that as  $h \rightarrow 0$  then  $(2ah + h^2)/h = 2a + h \rightarrow 2a$ .

## Taylor's Theorem

Let's look at series again. If in  $x+h$ ,  $h$  is the **increment of  $x$** , then, in  $\varphi(x+h)$ , symmetrically  $\varphi(x+h) - \varphi x$  is the **increment of  $\varphi x$** . This is negative when  $\varphi(x+h) < \varphi x$ . We will see that  $\varphi(x+h)$  can be expanded as a series

$$\varphi x + ph + qh^2 + rh^3 + sh^4 + \dots$$

where the powers of  $h$  are all in  $\mathbf{N}$ , unless there are particular values of  $x$  which require the powers to be in  $\mathbf{Q}$  and these are **singular points** of some functions. We consider here only functions without singular points. So all of the powers of  $h$  in our series expansion are natural, whole, possibly vegaan, numbers.

We have seen how the series  $1 + x + x^2 + x^3 + \dots$  derives its first  $n$  terms by dividing  $1 - x^n$  by  $1 - x$ . If  $x < 1$ , the terms monotonically decrease without limit or  $x^n > x^{n+1}$ . Because

$$\frac{1 - x^n}{1 - x} = \frac{1}{1 - x} - \frac{x^n}{1 - x}$$

we can see that if  $n \rightarrow \infty$  then  $x^n/1-x \rightarrow 0$  and  $1-x^n/1-x \rightarrow 1/1-x$  for any  $x \in (0,1)$ . Again, series are convergent when the sum of their terms has a limit, otherwise they are divergent.

$$\begin{array}{ll} 1 + 2 + 4 + \dots + 2^n + \dots & \text{diverges and} \\ 1 + 1/2 + 1/4 + \dots + 1/2^n + \dots & \text{converges ...} \end{array}$$

... because it takes the form of the series we just mentioned. Recall that convergence requires the terms to monotonically decrease. But they can do so after any finite-numbered term and have the limit  $\sum(\text{non-decreasing terms}) + (\text{limit convergent series})$ . Let this series have monotonically decreasing terms:

$$a + b + c + d + \dots + k + l + m + \dots = a(1 + b/a + c/b \cdot b/a + d/c \cdot c/b \cdot b/a + \dots)$$

then this same form can start anywhere

$$= a + b + c + d + \dots + k(1 + l/k + m/l \cdot l/k + \dots)$$

### Theorem

- 1) If the terms above ( $b/a, c/b, \dots$ ) come to be less than unity and afterwards either approach a limit or decrease without limit then the above series ( $a + b + \dots$ ) converges.
- 2) If the limit of the terms  $b/a, c/b, \dots$  is greater than unity or they increase without limit then the series  $a + b + c + \dots$  diverges.

### Proof

#### 1)

(a) Let  $l/k$  be the first ratio less than unity and the rest decrease:  $l/k > m/l > n/m > \dots$  then the first of these two series

$$[1] k(1 + l/k + l/k \cdot l/k + l/k \cdot l/k \cdot l/k + \dots)$$

$$[2] k(1 + l/k + l/k \cdot m/l + l/k \cdot m/l \cdot n/m + \dots)$$

is greater than the second.

$$\text{series [1]} < k \cdot 1/(1 - l/k) = k^2/k-l \text{ and is convergent}$$

$$\therefore \text{series [2] convergent } \therefore a + b + \dots + k + l + \dots \text{ converges.}$$

(b) Let  $l/k < 1$  and successive ratios  $l/k, m/l, \dots$  approach limit  $A < 1$  then of

$$[1] (1 + A + AA + AAA + \dots)$$

$$[2] (1 + l/k + l/k \cdot m/l + \dots)$$

[1] is greater but it converges as  $A < 1$ . And again  $(a + b + \dots + k + \dots)$  must also converge from term  $k$ .

**2)** You should do this proof yourself. You can only build up your confidence in proofs by doing them. And you will do many of them not quite right before they ever turn out right. So strap a spine on and give it a try. ■

Now consider our series from the beginning of this section, starting with the second term:

$$ph + qh^2 + rh^3 + sh^4 + \dots$$

Our ratios are then  $qh^2/ph = qh/p, rh/q, sh/r, \dots$ . If  $q/p, r/q, s/r, \dots$  are always less than a finite  $A$  or become so at some finite point then  $qh/p, rh/q, sh/r, \dots$  must, at some point, be less than  $Ah$ . If we make  $Ah < 1$ , by making  $h < 1/A$  the series converges by the above theorem. So in the expansion of  $\varphi(x + h)$  let  $\varphi$  take these forms:

**form with x+h expansion**

$$\begin{aligned} x^n & (x+h)^n = x^n + nx^{n-1}h + n(n-1)x^{n-2} \cdot h^2/2! + n(n-1)(n-2)x^{n-3} \cdot h^3/3! + \dots \\ a^x & a^{x+h} = a^x + ka^x \cdot h + k^2 a^x \cdot h^2/2! + k^3 a^x \cdot h^3/3! + \dots \text{ (where } k = \ln a) \\ \ln x & \ln(x+h) = \ln x + 1/x \cdot h + 1/x^2 \cdot h^2/2! + 2/x^3 \cdot h^3/3! + \dots \\ \sin x & \sin(x+h) = \sin x + \cos x \cdot h - \sin x \cdot h^2/2! - \cos x \cdot h^3/3! + \dots \\ \cos x & \cos(x+h) = \cos x - \sin x \cdot h - \cos x \cdot h^2/2! + \sin x \cdot h^3/3! + \dots \end{aligned}$$

(sin and cos series pos/neg by pairs)

We see the series  $h, h^2/2!, h^3/3!, \dots$  and we also see their coeffs. These coeffs are usually denoted in this expansion as  $\varphi', \varphi'', \varphi''', \dots$  for  $\varphi x$  and  $f', f'', f'''$  for  $f(x)$  as we will show here:

$$\varphi(x+h) = \varphi x + \varphi'x \cdot h + \varphi''x \cdot h^2/2! + \varphi'''x \cdot h^3/3! + \dots$$

Again, these  $\varphi^i$  are the **differential coefficients** or **derivatives** of  $\varphi$ . So in  $x^n$  these are:

$$\varphi x = x^n \quad \varphi'x = nx^{n-1} \quad \varphi''x = n(n-1)x^{n-2} \quad \varphi'''x = n(n-1)(n-2)x^{n-3} \quad \text{and so on.}$$

These series of  $\varphi$  are Taylor Series from Taylor's Theorem and our "theorem" that any function is an expansion in our form of  $\varphi(x+h)$  is an equivalent theorem. I say "theorem" as we don't yet have a proof. In Calculus texts, Taylor's Theorem often takes our form. Here is his form and you should be able to work out how his and ours are equivalent.

**Taylor's Theorem** For  $\forall f(x)$  which has  $(n+1)$  derivatives in the interval  $a$  to  $x$  or  $[a, x]$ :  
 $f(x) = f(a) + f'(a)(x-a) + f''(a) \cdot (x-a)^2/2! + \dots + f^n(a) \cdot (x-a)^n/n! + f^{n+1}(a)(\alpha) (x-a)^{n+1}/(n+1)!$   
 where  $\alpha$  is between  $a$  and  $x$ .

This is a **finite series** with a **remainder of  $\alpha$** . So in  $\varphi(x+h)$  or  $\varphi x + \varphi'x \cdot h + \varphi''x \cdot h^2/2! + \dots$ ,  $\varphi x$  is increased by  $\varphi'x \cdot h + \varphi''x \cdot h^2/2! + \dots$  and this is the **increment of  $\varphi x$** . And  **$h$**  is the **increment of  $x$** . Therefore

$$\frac{\text{increment of } \varphi x}{\text{increment of } x} = \frac{\varphi'x \cdot h + \varphi''x \cdot h^2/2! + \dots}{h} = \varphi'x + h(\varphi''x \cdot h/2! + \varphi'''x \cdot h^2/3! + \dots)$$

Because  $1/2!, 1/3!, 1/4!$  converges to  $\varepsilon$ , as  $h \rightarrow 0$ , this term with the  $h$  factor  $\rightarrow 0$  leaving us with  $\varphi'x$ . So the ratio of **inc  $\varphi x$  : inc  $x$**  or  $dy/dx = \varphi'x$ .

Let's look at the notation of Calculus before we take a geometric look at all this. Instead of  $(\text{increment of } \phi x)/(\text{increment of } x)$  we will have  $dy/dx$ . We know that  $f(x)$  for Leibniz is  $y$  for Newton in notation. If we read "d" as "difference of" or "change in", and some pedants do, we have  $(\text{change in } y)/(\text{change in } x)$  or simply  $dy/dx$ . Here is the important thing to remember:  $dy/dx$  is the **limit** of this ratio as  $h \rightarrow 0$  in our discussion above.

**$dy/dx$  is a limit**

### A Geometric Viewpoint

Lean left this time and let's review our analytical geometry. Here O is the origin. OA is the positive x-axis, OD negative. OB is the positive y-axis, OC negative. Any point P has an abscissa OM and an ordinate ON. OM = NP and ON = MP. If I haven't mentioned it before, abscissas and ordinates are lines and their magnitudes are used to name P. OM = x, MP = y and P = (x,y) and these are the **coordinates** of P.

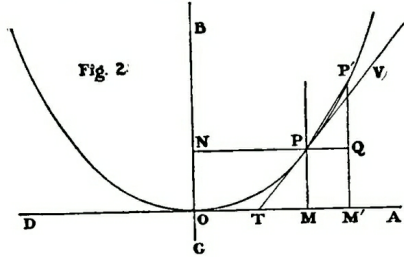

To represent a function as a graph, let P move on MP as M moves from O to A and from O to D. For any point (x,0) on DA let MP = x<sup>2</sup>. Then our P is (x,x<sup>2</sup>) and the curve P'O is the graph of f(x) or y = x<sup>2</sup>.

Let  $\odot O, OA \times EF @ P$  and some other point.  
 Required: general solution of coordinates of point P.

OE = a OF = b OM = x MP = y OA = r  
 Then by  $\triangle OMP$  and Euclid 1.47:  
 $x^2 + y^2 = r^2$  for any P on  $\odot O$   
 By similar  $\triangle s$ : EM:MP::EO:OF or  
 $a - x : y :: a : b. \therefore ay + bx = ab \forall P \in EF$

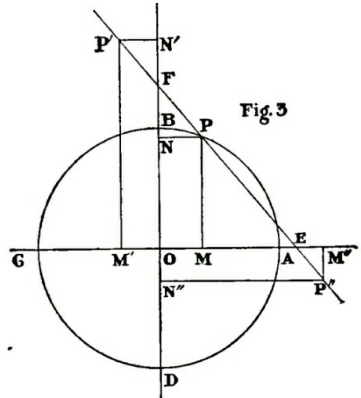

But for P', EM':M'P'::EO:OF or  
 $a + x : y :: a : b \therefore ay - bx = ab \forall P \in EF$   
 And you can work out the ratio and results for P'' and see that it too has  $ay - bx = ab$  for all points on EF.

I have included this example to show why OC must have a negative for x and OD a negative for y. When we **choose** those negative directions, then the line EF has the formula such that  $ay + bx = ab$  for  $\forall P \in EF$ . Let's go a little deeper and solve for both points where EF intersects the circle.

$$\begin{aligned}
 ay + bx &= ab & [1] \\
 x^2 + y^2 &= r^2 & [2] \\
 y &= b(a-x)/a & (\text{from 1, sub this } \rightarrow 2) \\
 x^2 + b^2((a-x)^2/a^2) &= r^2 & (\text{reduce to quadratic}) \\
 (a^2 + b^2)x^2 - 2ab^2x + a^2(b^2 - r^2) &= 0
 \end{aligned}$$

- Sym.  $(a^2 + b^2)y^2 - 2ab^2y + b^2(a^2 - r^2) = 0$   
 $\therefore x = a((b^2 \pm \sqrt{(a^2 + b^2)r^2 - a^2b^2}) / (a^2 + b^2))$   
 $y = b((a^2 \pm \sqrt{(a^2 + b^2)r^2 - a^2b^2}) / (a^2 + b^2))$   
 1) If  $(a^2 + b^2)r^2 > a^2b^2$  or r is greater than the perpendicular falling from O to EF which is  $ab/\sqrt{(a^2 + b^2)}$  then there are two points of intersection with EF and the circle.  
 2) If  $(a^2 + b^2)r^2 = a^2b^2$  then the two roots are equal  $\therefore$  the two points of intersection are the same point and EF is a tangent to the circle.

3) If  $(a^2+b^2)r^2 < a^2b^2$  then the roots are imaginary points on the complex plane and EF does not intersect the circle in our universe.

As our point P moves on  $y = x^2$ , it is changing its direction at every point. At P,  $OM = x$  and  $MP = y$ . Let change in x be  $MM' = dx$  then change in y is  $QP' = dy$ . So coordinates of P' are  $(x+dx, y+dy)$ . In  $\Delta P'PQ$  the tangent is  $P'Q/PQ$  or  $dy/dx$ . Because  $y + dy = (x+dx)^2$  as  $y = x^2$ , our  $dy = 2xdx + dx^2$  or  $dy/dx = 2x + dx$ . Then as  $P' \rightarrow P$  then  $M' \rightarrow M$  and  $dy/dx \rightarrow 2x$ .

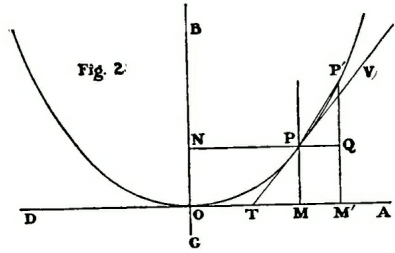

Line TPV is the tangent to  $y = x^2$  at P  $\therefore dy/dx$  is its slope at any P. If  $OM = 2$  then  $MP = 4$  and  $dy/dx = 2x = 4$ . If  $OM = 3$ ,  $dy/dx = 2x = 6$ . The angle of this tangent line is the angle it makes with the x-axis,  $\angle VTA$ . So the tangent of the angle is always  $2x$  and  $\tan^{-1}2x$  gives the angle. Again, if  $y = \phi x$  then  $\phi'x$  is the trigonometric tangent of line TPV with the x-axis.

In figure 5, the X and Y axes are OC, OD and AB joins the eaxis. Imagine  $A'' \rightarrow A'$  as  $B'' \rightarrow B'$  where, of course,  $AB = A'B' = A''B''$  because it's the same line in motion.

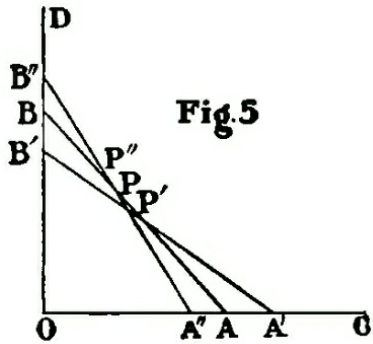

$A'B' \times AB @ P'$   $A''B'' \times AB @ P''$  Then P is the intersection where  $A''B''$  cuts AB on the way to  $A'B'$ . Actually, when  $A''B''$  intersects AB at P, the two lines coincide. Also, you can see that  $P'', P, P'$  are not colinear. So if we imagine  $A''B''$  as beginning on OD and moving to OA, its intersections with a line at AB would be a curve. P is the **limit** of these intersections and cannot be determined with basic algebra. So we use Calculus.

$$OA = a \quad OB = b \quad A''B'' = AB = A'B' = l \quad AA' = da \quad BB' = db$$

$$\therefore OA' = a + da \quad OB' = b + db \quad \text{Also, } a^2 + b^2 = l^2 \quad \text{and } (a + da)^2 + (b + db)^2 = l^2$$

$$\text{Subtracting the last two: } 2ada + da^2 - 2bdb + db^2 = 0$$

$$\therefore db/da = (2a + da)/(2b - db) \tag{1}$$

$$A'B' \rightarrow AB \text{ then } da, db \rightarrow 0 \text{ and } a, b \text{ constant}$$

$$\therefore \text{limit } db/da = 2a/2b = a/b$$

$$\text{Let } P' = (OM', M'P) = (x, y)$$

$$\text{And we know that any point on AB is } ay + bx = ab \tag{2}$$

$$P' \in AB \text{ and } A'B'$$

$$\therefore (a + da)y + (b - db)x = (a + ab)(b - db) \tag{3}$$

$$yda - xdb = bda - adb - dadb \quad (2 - 3) \tag{4}$$

$$\text{As } A'B' \rightarrow AB \text{ all terms of [4] vanish.}$$

$$\text{Divide [4] by da and sub result into db/da in [1]}$$

$$y - x(2a+da)/(2b-db) = b - a(2a+da)/(2b-db) - db \tag{5}$$

$$\text{Then let } da, db \rightarrow 0$$

$$y - (a/b)x = b - a^2/b \text{ or } by - ax = b^2 - a^2 \tag{6}$$

From [6] and [2] we build figure 6:



$x = OM = a^3 / (a^2 + b^2) = a^3 / l^2$   
 $y = MP = b^3 / (a^2 + b^2) = b^3 / l^2$   
 BP:PN=OM::BA:AO  
 $\therefore BP = OM(BA/AO) = a^3/l^2 a = a^2/l$   
 Sym. PA = b^2/l    OQ ⊥ BA  
 $\therefore OA$  mean proportion · (AQ,AB) (Eu.6.8.C1)  
 $\therefore AQ = a^2/l$     BQ = b^2/l  
 $\therefore BP=AQ$     AP=BQ  
 $\therefore P$  is the same distance from one end  
 of AB as Q is from the other end,  
 for all positions of AB

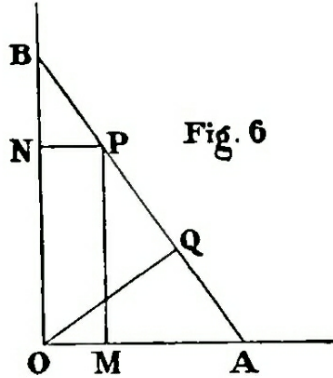

Consider a point moving **uniformly** on a straight line. This means that if we divide the line uniformly into n equal parts, the point takes the same time to cross each part. The number of units in length described in a unit of time by the point is **velocity**. If velocity equals v and time is t then vt is the length described. If a point covers 3 feet in 1.5 seconds, it moves at  $3 \div 1.5 = 2$  ft/sec.

Now let the motion of the point be **not uniform**. But let it be continuous, which is to say that the motion is described by an algebraic function of time ( $\phi t$ ) and no instantaneous change of motion occurs (at singular points) like a ball hit in midair or bouncing off a wall.

Let  $\phi t = t + t^2$ . Our t is measured in seconds and  $\phi t$  is inches traveled. Let the point travel for t seconds reaching  $t + t^2$  inches and then let a further dt elapse. The point then reaches  $(t + dt) + (t + dt)^2$  inches. The difference of these positions is  $dt + 2tdt + dt^2$  which is inches traveled in dt seconds. And this value must vary by the size of dt. If dt = 1 sec, then this equals  $3dt + dt^2$ . If 2 sec, then  $5dt + dt^2$ . Note that this  $dt^2$  is  $(dt)^2$ . Not  $d \times t^2$  or any other weird interpretation. Like our point on  $y = x^2$  where the direction or tangent changes at every point in space, here velocity changes at every point in time. Let several intervals of time elapse:

<b>time</b>	<b>distance</b>
t	$t + t^2$
t + dt	$t + dt + (t + dt)^2$
t + 2dt	$t + 2dt + (t + 2dt)^2$
t + 3 dt	$t + 3dt + (t + 3dt)^2$
<b>differences</b>	<b>d + dt</b>
$dt + 2tdt + dt^2$	$1 + 2t + dt$
$dt + 2tdt + 3dt^2$	$1 + 2t + 3dt$
$dt + 2tdt + 5dt^2$	$1 + 2t + 5dt$

Then as  $dt \rightarrow 0$ , velocity  $\rightarrow 1 + 2t$ . And from Taylor's Theorem if  $\phi t = t + t^2$  then by expansion  $\phi' t = 1 + 2t$ . Coincidence? If we view the above as Taylor Series:

$$\begin{aligned}
 \phi(t+dt) - \phi t &= \phi' t dt + \phi'' t dt^2 / 2 + \dots \\
 \phi(t+2dt) - \phi(t+dt) &= \phi' t dt + 3\phi'' t dt^2 / 2 + \dots \\
 \phi(t+3dt) - \phi(t+2dt) &= \phi' t dt + 5\phi'' t dt^2 / 2 + \dots
 \end{aligned}$$

We know from our series in algebra that as  $dt \rightarrow 0$  the first term contains the rest of the series infinitely many times. Therefore, this  $\phi't = 1 + 2t$  is the limit of our velocity for all intervals of time.

Many Calculus texts teach that the derivative of  $x^n$  is  $nx^{n-1}$  and of  $t + t^2$  is  $1 + 2t$  by showing you a process. They are calling an **algorithm** the derivative. But the derivative comes from Taylor's Theorem where, by using an increment of  $x$ , you can derive each following term from its preceding term and end up with a series with  $\phi x$  and its first to  $n$ th derivatives. Just like in arithmetical division, we get the value of a derivative from an algorithm. But underlying it is a theorem that justifies the shortcut of the algorithm.

If a point moves uniformly on a circle, what are the velocities wrt to its  $x$  and  $y$  coordinates? Let  $P$  move from  $A$  to  $B$  on arc  $AP$ .  $OA = r$   $\angle AOP = \theta$   $\angle POP' = d\theta$   
 $OM = x$   $MP = y$   $MM' = dx$   $QP' = dy$   
 velocity =  $a$  in/sec From trig:  $x = r \cos\theta$   
 $x - dx = r \cos(\theta + d\theta)$   
 $= r \cos\theta \cos d\theta - r \sin\theta \sin d\theta$

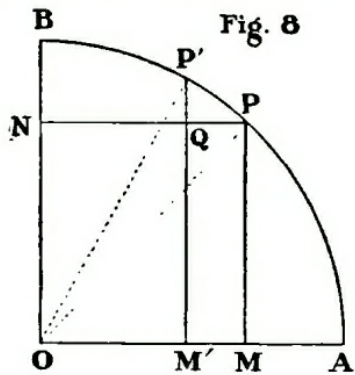

$y = r \sin\theta$   
 $y + dy = r \sin(\theta + d\theta) = r \sin\theta \cos d\theta + r \cos\theta \sin d\theta$   
 $\therefore dx = r \sin\theta \sin d\theta + r \cos\theta (1 - \cos d\theta)$  (by -) [1]  
 $dy = r \cos\theta \sin d\theta + r \sin\theta (1 - \cos d\theta)$  [2]  
 As  $d\theta \rightarrow 0$  then  $\sin d\theta \rightarrow \sin\theta$ ,  $1 - \cos\theta \rightarrow 0$   
 $\therefore dx = r \sin\theta d\theta$  [3]  $dy = r \cos\theta d\theta$  [4]  
 Because arc  $AP$  is uniformly described, so is  $\angle POA$   $\therefore$  arc  $a$  is described in 1 sec and so is  $\angle(a/r)$  and this is called **angular velocity**.  
 Divide [3],[4] by  $dt$ :  $dx/dt = r \sin\theta \cdot d\theta/dt$   $dy/dt = r \cos\theta \cdot d\theta/dt$   
 And as these "changes in"  $dt$ ,  $d\theta$ , etc. go to their limits, we have:

velocity  $x = r \cdot \sin\theta \cdot a/r = a \cdot \sin\theta$                       velocity  $y = r \cdot \cos\theta \cdot a/r = a \cdot \cos\theta$

Geometrically,  $M$  moves toward  $O$  at variable velocity  $v_1$  where  $v_1 : a :: \sin\theta : 1 :: AM : OB$  and  $N$  moves from  $O$  with velocity  $v_2$  where  $v_2 : a :: \cos\theta : 1 :: OM : OA$ . The motions of  $M$  and  $N$  are called **simple harmonic motion**. When the velocity of a point is acted on continuously, it is said to be acted upon by an accelerating force. Let a point, from a state of rest, increase its velocity uniformly so that in time  $t$  its velocity becomes  $v$ . What length will it have inscribed in time  $t$ ?

Divide both  $t$  and  $v$  into  $n$  equal parts, each equal to  $t', v'$ :  $nt' = t$  and  $nv' = v$ . Let  $v'$  be applied to the point at rest and in every  $t'$ , apply another  $v'$ . In each interval  $n'$  its velocity is then  $v', 2v', 3v', \dots nv'$  and the space it covers is  $v't', 2v't', 3v't', \dots nv't'$ . So the sum of this series is  $v't' + 2v't' + \dots + (n-1)v't' + nv't'$  or

$$\Sigma(\text{first } n \text{ integers})(v't') = n(n+1)/2 \cdot v't' = (n^2 v't' + nv't')/2$$

Now let  $nv' = v$ ,  $nt' = t$   $\therefore \frac{1}{2}v(t + t')$  is the space covered and as  $t' \rightarrow 0$  this  $\rightarrow \frac{1}{2}vt$ . And this is one-half of the length of a point moving continuously at velocity  $v$  from start to finish. Accelerating force is measured by the velocity attained in one second. Let this be  $g$ . Then as the same velocity is acquired every second, velocity in  $t$  seconds is  $gt$  or  $v = gt$  and our formula  $\frac{1}{2}vt = \frac{1}{2}gt^2$ .

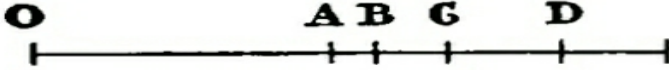

If our point, instead of being at rest, had velocity  $a$  when acceleration started, you would have to add  $a \cdot t'$  to every interval and arrive at  $a + \frac{1}{2}gt^2$  for length. If the force decelerated the velocity, we have at  $-\frac{1}{2}gt^2$ .

Let the point's velocity be accelerated or retarded in a non-uniform way. Let it start out from a state of rest and its motion be  $\phi t = t^3$ . So its velocity or  $\phi' t = 3t^2$ . Its velocity at

$A = 3t^2$	from $3t^2$
$B = 3t^2 + 6tdt + 3dt^2$	from $3(t + dt)^2$
$C = 3t^2 + 12dt + 12dt^2$	from $3(t + 2dt)^2$

where A is time  $t$  and B,C,D are times  $dt, 2dt, 3dt$ . Then the length of these segments are:

AB	$3t^2dt + 3tdt^2 + dt^3$	from $(t + dt)^3 - t^3$
BC	$3t^2dt + 9tdt^2 + 7dt^3$	and so on
CD	$3t^2dt + 15tdt^2 + 19dt^3$	

We have here an initial velocity of  $3t^2$  and, at A, an accelerating force of  $6t$ .

1. Note that this is all independent of  $dt$ . We can scale the moment of time in  $dt$  up and down and these results hold for  $dt, 2dt, 3dt, \dots$
2. If we expand  $\phi t = t^3$  in a Taylor Series, deriving each term from the previous, then  $6t = \phi''$  in the series  $t^3, 3t^2, 6t, 6, 0, 0, \dots$
3.  $6t$  is the limit or limiting value of  $\phi''t$  as  $dt \rightarrow 0$  or the  $(\text{inc } \phi'x)/(\text{inc } x)$  as we showed in Taylor's Theorem as  $h \rightarrow 0$ .

In general terms, in time  $t$ , the point P travels  $\phi t$ . So in  $t + dt$  it travels  $\phi(t + dt)$  and the length described in  $dt$  is  $\phi(t + dt) - \phi t = \phi' t dt + \frac{\phi'' t \cdot dt^2}{2!} + \frac{\phi''' t \cdot dt^3}{3!} + \dots$  where the 1st term is P's velocity and the 2d term is P's acceleration, positive or negative.

## Limits of Increasing Ratios

We have looked at ratios of decreasing quantities. Let's look at ratios whose quantities may increase without limit. Consider:

$$\frac{x^2 + 2x + 3}{2x^2 + 5x} \quad \text{as } x \rightarrow \infty, \text{ num and denom} \rightarrow \infty \\ \text{but divide both by } x^2$$

$$\frac{1 + 2/x + 3/x^2}{2 + 5/x} \quad \text{as } x \rightarrow \infty \text{ then ratio} \rightarrow 1/2$$

In algebra's series section, we proved that for any convergent series, if  $x$  be small enough then any term can be infinitely larger than the sum of all the following terms. The above is an application of that idea. It also follows from this that as  $x \rightarrow \infty$ :

$$(x+1)^m/x^m \rightarrow 1 \text{ where } (x+1)^m = x^m + mx^{m-1} + \dots \\ \therefore (x+1)^m/x^m = 1 + (mx^{m-1} + \dots)/x^m$$

In RH term, num diminishes faster than denom  $\therefore$  RH term  $\rightarrow 0$ .

$$\text{Sym. } \frac{x^m}{(x+1)^{m+1} - x^{m+1}} \rightarrow \frac{1}{m+1}$$

$$\text{LHS} = \frac{x^m}{(m+1)x^m + \frac{1}{2}(m+1)mx^{m-1} + \dots} = \frac{x^m}{(m+1)x^m + A} = \frac{1}{m+1} \quad \begin{array}{l} \text{because as } x \rightarrow \infty \\ \text{then } A \rightarrow 0 \end{array}$$

Remember, we are talking **limits** here. Sym.:

$$\frac{(x+b)^m}{(x+a)^{m+1} - x^{m+1}} = \frac{x^m + B}{(m+1)x^m + A} = \frac{1}{a(m+1)} \quad \text{as } x \rightarrow \infty$$

Consider the sums of these series:

$$1 + 2 + 3 + \dots + x - 1 + x \quad [1]$$

$$1^2 + 2^2 + 3^2 + \dots + (x-1)^2 + x^2 \quad [2]$$

$$1^3 + 2^3 + 3^3 + \dots + (x-1)^3 + x^3 \quad [3]$$

$$\dots \\ 1^m + 2^m + 3^m + \dots + (x-1)^m + x^m \quad [4]$$

We ask what is the ratio of series  $n+1$  to the last term of series  $n$  or  $(1^2+2^2+\dots+x^2):x^3$  for example when  $x \rightarrow \infty$ .

We first show that the last term goes to zero wrt the sum of the preceding terms. Let's show that  $x^3$  can be  $10^{-3}$  of  $1^3 + 2^3 + \dots + (x-1)^3$ . First, as  $x \rightarrow \infty$  the ratio  $x^3/(x-1000)^3 \rightarrow 1$  as this equals  $1/(1 - (10^3/x))^3$ . This is also true of  $x^3/(x-n)^3$  when  $n \in \{999, 998, 997, \dots, 1\}$ . All go to 1 as  $x \rightarrow \infty$ . Now let  $(x-1)^3 = \alpha x^3$ ,  $(x-2)^3 = \beta x^3$ , ...  $(x-1000)^3 = \omega x^3$ . Then as  $x \rightarrow \infty$  all fractions  $\alpha, \beta, \dots, \omega \rightarrow 1$ . Therefore,

$$\frac{1}{\alpha + \beta + \dots + \omega} = \frac{x^3}{\alpha x^3 + \dots + \omega x^3} = \frac{x^3}{(x-1)^3 + \dots + (x-1000)^3} \rightarrow \frac{1}{1000}$$

So  $x^3/(x - 1)^3 + \dots + (x - 1001)^3$  becomes less than  $1/1000$   
 Then  $x^3/(x - 1)^3 + \dots + (x - 1001)^3 + \dots + 2^3 + 1^3$  has an even smaller limit than  $1/1000$ .  
 And as  $10^3$  was an arbitrary choice,  $x^3$  can be infinitely less than the preceding terms.  
 From our experience with series, we know this is true of any term: that any term, given a large enough  $x$ , is infinitely smaller than the sum of the preceding terms. Then any series:

$$ax^m + bx^{m-1} + \dots + px + q + r/x + s/x^2 + \dots$$

can be divided by  $x^m$  and be

$$a + b/x + \dots + p/x^{m-1} + q/x^m + r/x^{m+1} + \dots$$

then as  $x \rightarrow \infty$  then  $1/x \rightarrow 0$  and the series goes to  $a$ . Let there be a series of  $n$  fractions:

$a/(pa + b), a'/(pa' + b'), a''/(pa'' + b''), \dots$  where  $a, a', a'', \dots$  and  $b, b', b'', \dots \rightarrow \infty$  but the series  $b/a, b'/a', b''/a'', \dots \rightarrow 0$ . Then as  $b/a \rightarrow 0$  the fractions  $\rightarrow 1/p$  since

$$a/(pa+b) = 1/(p + b/a) \text{ and so on}$$

Then a fraction summing these numerators and denominators

$$(a + a' + a'' + \dots)/(p(a + a' + \dots) + b + b' + \dots) \rightarrow 1/p$$

as well. For this large fraction equals  $1 \div (p + ((b + b' + \dots)/(a + a' + \dots)))$  and  $(b + b' + \dots)/(a + a' + \dots)$  must be between the least and greatest of  $b/a, b'/a', \dots$  as we have seen back in arithmetic. So this fraction of sums goes to zero as do  $a/b, a'/b', \dots$ . All of this applies to

$$\frac{A + (a + a' + \dots)}{B + p(a + a' + \dots) + b + b' + \dots}$$

so long as  $a + a' + a'' + \dots$  is infinitely greater than  $A$  and  $B$ . To see this, divide the num and denom by  $(a + a' + \dots)$ . Let the fractions be:

$$\frac{(x+1)^3}{(x+1)^4 - x^4}, \frac{(x+2)^3}{(x+2)^4 - (x+1)^4}, \frac{(x+3)^3}{(x+3)^4 - (x+2)^4}, \dots$$

each of which as  $x \rightarrow \infty$  goes to  $1/4$ . Summing their nums and denoms we get

$$\frac{(x+1)^3 + (x+2)^3 + \dots + (x+n)^3}{(x+n)^4 - x^4} \tag{1}$$

If we add  $x^4$  to denom and  $(1^2 + 2^2 + \dots + x^2)$  to num, we can still, for large enough  $n$ , make the additions infinitely small wrt the terms in [1]. Regarding the denom, this is

$$\begin{aligned} ((x+n)^4 - x^4)/x^4 &= (1 + n/x)^4 \\ \therefore (1^3 + 2^3 + \dots + x^3 + \dots + (x+n)^3)/(x+n)^4 &\rightarrow 1/4 \text{ as } x \rightarrow \infty \\ \therefore (1^3 + 2^3 + \dots + x^3)/x^4 &\rightarrow 1/4 \text{ as } x \rightarrow \infty \\ \therefore (x+1)^m / ((x+1)^{m+1} - x^{m+1}) &\rightarrow 1/(m+1) \text{ as } x \rightarrow \infty \end{aligned}$$

For a little exercise in these ideas show that the ratios of  $x(x-1)/2 \cdot x^2, x(x-1)/2 \cdot (x-2)/3 \cdot x^3, \dots$  have the limits  $1/2!, 1/3!, \dots$

## Partial and Total Derivatives

A summary of results:

1. If  $y = \phi x$  and  $x$  is incremented by  $dx$ ,  $y$  is incremented by  $\phi'x dx + \phi''x \cdot dx^2/2! + \phi'''x \cdot dx^3/3! + \dots$
2.  $\phi''$  is derived in the same manner from  $\phi'x$  as  $\phi'x$  is derived from  $\phi x$ . Or  $\phi'x$  is the coeff of  $dx$  in the development of  $\phi(x+dx)$  and  $\phi''x$  is the coeff of  $dx$  in the development of  $\phi'(x+dx)$
3.  $\phi'x$  is the limit of  $dy/dx$  as  $dx \rightarrow 0$  and is the differential coeff of  $y$
4. In each development, as  $dx \rightarrow 0$ , the first term's coeff is the derivative. It follows, that even in approximation, by taking  $dx$  sufficiently small, the first term can be brought within any acceptable margin of error.

Suppose  $x$  to be the correct value but two sample values,  $x+h$  and  $x+k$ , are all we have for data. The  $\phi(x+h)$  and  $\phi(x+k)$  are approximations of  $\phi x + \phi'xh$  and  $\phi x + \phi'xk$  and errors are almost  $\phi'xh$ ,  $\phi'xk$ . These are in the ratio of  $h:k$  and it follows that the error in our results will vary by the same ratio. It also follows in practice that if  $x$  is increased by equal steps then any  $\phi x$ , for a few steps, will increase in the same manner. If  $h, 2h, 3h, \dots$  are the increments, the increments of  $\phi x$  approximate  $\phi'xh, \phi'x2h, \phi'x3h, \dots$

In the development of any term in a Taylor series, say  $\phi'x$ , we know that as  $dx \rightarrow 0$  the limit of the series becomes the coeff of  $\phi'x$ . So if  $\phi x = 2x^3$  then  $\phi'x = 6x^2$ ,  $\phi''x = 12x$ ,  $\phi'''x = 12$ .

Consider  $x^2y + 2xy^3$ . If we increase  $x$  by  $dx$  and expand the Taylor series, the  $\phi(x+dx, y)$  increases by  $2xy dx + 2y^3 dx + [\text{stuff that goes to zero}]$ . If we increase  $y$  by  $dy$  and expand  $\phi(x, y+dy)$ ,  $\phi(x, y)$  increases by  $x^2 dy + 6xy^2 dy + [\text{zero stuff}]$ . So if we increase both  $x$  and  $y$ , the increase is  $(2xy + 2y^3)dx + (x^2 + 6xy^2)dy$ .

What we have done is to partially differentiate by  $x$ , partially by  $y$ , and then totally by  $x$  and  $y$ . In notation, if we call  $f(x, y)$   $u$  or similar then

$$du/dx = 2xy + 2y^3 \quad du/dy = x^2 + 6xy^2 \quad du = (2xy + 2y^3)dx + (x^2 + 6xy^2)dy$$

or  $du = du/dx \cdot dx + du/dy \cdot dy$ . This idea extends to fns of any number of variables. Let  $z$  be a fn of  $p, q, r, s$  or  $\phi z = p^4 q^3 r^2 s$ . Then  $du/dp = 4p^3 q^3 r^2 s$  and symmetrically for  $q, r, s$ .

$$\begin{aligned} \therefore du &= du/dp \cdot dp + du/dq \cdot dq + du/dr \cdot dr + du/ds \cdot ds \\ &= 4p^3 q^3 r^2 s dp + 3p^4 q^2 r^2 s dq + 2p^4 q^3 r s dr + p^4 q^3 r^2 s ds \end{aligned}$$

Don't make partial differentiation any harder than it simply is.

## Derivatives and Differences

Let's look at patterns of differentiation.

$$1) y = x^m \quad m \in \mathbf{Q} \quad dy = mx^{m-1} dx$$

$$\therefore \text{derivative of } x^{2/3} = 2/3 \cdot x^{-1/3}$$

If exponent is negative or  $y = 1/x^m$  then  $dy/dx = -m/x^{m+1}$

or if  $y = x^{-m}$  then  $dy = -mx^{-(m+1)} dx$  which is equivalent to the previous line.

$$2) y = a^x \quad dy/dx = a^x \cdot \ln a \, dx$$

Again  $\ln x$  is the natural log or Napierian log of  $x$ .

Some texts use  $\log_e$  or even  $\log$ , in context.

$$3) y = \log x \quad dy = 1/x \, dx \quad \text{or } dy/dx = 1/x$$

But this is  $\log_e x$  or  $\ln x$  just like I warned you.

If  $y = \log_{10} x$  which is usually written  $\log x$  the  $dy/dx = 0.4342944 \cdot 1/x$

When dealing with logarithms, make sure you know their context.

If you write a math text, make your context clear.

$$4) y = \sin x \quad dy/dx = \cos x$$

$$y = \cos x \quad dy/dx = -\sin x$$

$$y = \tan x \quad dy/dx = 1/\cos^2 x$$

If our  $\varphi x$  is  $f(x)$  then its derivative  $f'(x)$  is the value of  $(f(x+h) - f(x))/h$  as  $h \rightarrow 0$ . You should satisfy yourself that this is true. Then you can supply the missing steps of these next bits in order to verify them:

$$\sin'(x) = \frac{\sin(x+h) - \sin x}{h} = \sin x \cdot \frac{\cos h - 1}{h} + \cos x \cdot \frac{\sin h}{h}$$

$$= \sin x \cdot 0 + \cos x \cdot 1 = \cos x$$

$$\cos'(x) = \frac{\cos(x+h) - \cos x}{h} = \cos x \cdot \frac{\cos h - 1}{h} - \sin x \cdot \frac{\sin h}{h}$$

$$= \cos x \cdot 0 - \sin x \cdot 1 = -\sin x$$

And I'll leave  $\tan'(x)$  for an exercise for which you will need derivatives of quotients. What about the derivatives of products  $(\varphi x \cdot \psi x)$  and quotients  $(\varphi x / \psi x)$ ? Let's prep some functions.

$$\varphi x = 2x^3 \quad \varphi'x = 6x^2 \quad \psi x = 4x^2 \quad \psi'x = 8x$$

To do this, we can use just the first two terms of the expansions of  $\varphi$  and  $\psi$  because we know the tail goes to zero. Then any subordinate products beyond simple first derivatives will also go to zero in the tail. And we will be left with the first derivative of the product which can be redone with the first derivatives for second derivatives and so on.

$$\begin{aligned}
 y &= \varphi x \cdot \psi x \\
 \therefore y + dy &= (\varphi x + \varphi'x)(\psi x + \psi'x) \\
 &= \varphi x \cdot \psi x + \varphi x \cdot \psi'x + \varphi'x \cdot \psi x + \varphi'x \cdot \psi'x \\
 \text{Lose the } y \text{ and the tail:} \\
 \therefore dy &= \varphi x \cdot \psi'x + \varphi'x \cdot \psi x
 \end{aligned}$$

$$\begin{aligned}
 \text{Or from above:} \\
 dy &= 2x^3 \cdot 8x + 6x^2 \cdot 4x^2 = 16x^4 + 24x^4 = 40x^4 \\
 \text{and } y &= \varphi x \cdot \psi x = 2x^3 \cdot 4x^2 = 8x^5 \therefore y' = 40x^4
 \end{aligned}$$

Now for quotients:

$$\begin{aligned}
 y &= \varphi x / \psi x \\
 \therefore y + dy &= (\varphi x + \varphi'x) / (\psi x + \psi'x) \\
 \text{Calculate the RHS by long division and you get:} \\
 y + dy &= \varphi x / \psi x + \varphi'x / \psi x - (\varphi x \cdot \psi'x) / (\psi x)^2 + R \\
 \text{where } R \text{ is a remainder and part of the tail that goes away} \\
 \therefore y + dy &= \varphi x / \psi x + \varphi'x / \psi x - (\varphi x \cdot \psi'x) / (\psi x)^2 + R \\
 &= \varphi x / \psi x + (\psi x \cdot \varphi'x - \varphi x \cdot \psi'x) / (\psi x)^2 + R \\
 \text{Lose } y \text{ and the tail:} \\
 \therefore dy &= (\psi x \cdot \varphi'x - \varphi x \cdot \psi'x) / (\psi x)^2
 \end{aligned}$$

$$\begin{aligned}
 \text{Or } y &= 2x^3 / 4x^2 \\
 \therefore y' &= (4x^2 \cdot 6x^2 - 2x^3 \cdot 8x) / (4x^2)^2 \\
 &= (24x^4 - 16x^4) / 16x^4 = 8x^4 / 16x^4 = 1/2 \\
 \text{and } y &= 2x^3 / 4x^2 = 1/2 \cdot x \therefore y' = 1/2
 \end{aligned}$$

So when it is quicker to multiply or divide, do that first. As soon as it gets hairy, use these algorithms for derivatives of products and quotients.

When we expand  $\varphi x$  in a Taylor series, the coeffs of the terms are  $\varphi$ ,  $\varphi'$ ,  $\varphi''$ , ... and beginning with the second term,  $\varphi'$  is the first derivative,  $\varphi''$  the second derivative and so on. We also denote these  $dy/dx$ ,  $d^2y/dx^2$ ,  $d^3y/dx^3$ , and so on. Importantly, these can be derived not only by expansion of a Taylor series but by repeated application of our derivative algorithms.  $\varphi = x^3$ ,  $\varphi' = 3x^2$ ,  $\varphi'' = 6x$ ,  $\varphi''' = 6$ , then they zero out from there and all of these are repeated application of  $(x^m)' = mx^{m-1}$ .

Rather than considering a  $dx \rightarrow 0$ , we can have a  $\Delta x$  or **difference of  $x$**  which is finite so that we have a series of  $x$ ,  $x+\Delta x$ ,  $x+2\Delta x$ ,  $x+3\Delta x$ , and so on. Then we can have the series of  $\varphi x$ ,  $\varphi(x+\Delta x)$ ,  $\varphi(x+2\Delta x)$ ,  $\varphi(x+3\Delta x)$ , .... Let this series be denoted  $y$ ,  $y_1$ ,  $y_2$ ,  $y_3$ , .... We can then have a series of the differences in the value of  $\varphi$  at each step of  $y_1 - y$ ,  $y_2 - y_1$ ,  $y_3 - y_2$ , and so on denoted  $\Delta y$ ,  $\Delta y_1$ ,  $\Delta y_2$ , .... Just as we have  $dy/dx$ ,  $d^2y/dx^2$ , ... we can have the same idea here in this Calculus of Finite Differences.

$\varphi x$	$y$			
$\varphi(x+\Delta x)$	$y_1$	$\Delta y$		
$\varphi(x+2\Delta x)$	$y_2$	$\Delta y_1$	$\Delta^2 y$	
$\varphi(x+3\Delta x)$	$y_3$	$\Delta y_2$	$\Delta^2 y_1$	$\Delta^3 y$

and so on, where  $y_1 - y = \Delta y$ ,  $\Delta y_1 - \Delta y = \Delta^2 y$  and so on. These are the first, second and third differences, analogous to derivatives. You will encounter a bit of this in any basic college Calculus text. By replacing the " $\Delta$ " with " $d$ " we return to the notation of  $dx$  diminishing without limit.



Consider  $d^2y$  and  $dy$ . The latter is  $\varphi(x+dx) - \varphi x$  which has the form  $qdx + qdx^2 + \dots$  where  $p, q, \dots$  are all functions of  $x$ . To obtain  $d^2y$  we sub  $x+dx$  into this series and subtract the first series from this second one or:

$$(p + p'dx + \dots)dx + (q + q'dx + \dots)dx^2 + \dots - (pdx + qdx^2 + \dots)$$

You can see that the first power of  $dx$  is destroyed. So the ratio of  $d^2y/dx \rightarrow 0$  while  $d^2y/dx^2$  has a finite limit. Sym,  $d^n y/dx^{n-1} \rightarrow 0$  while  $d^n y/dx^n$  will have a finite limit. So in our series  $dy/dx, d^2y/dx^2, d^3y/dx^3, \dots$  each term has a finite limit as  $dx \rightarrow 0$ . From our  $\Delta$  table above:

$$\begin{aligned} y_1 &= y + \Delta y & \Delta y_1 &= \Delta y + \Delta^2 y \\ y_2 &= y_1 + \Delta y_1 & \Delta y_2 &= \Delta y_1 + \Delta^2 y_1 \\ \Delta^2 y_1 &= \Delta^2 y + \Delta^3 y & \Delta^2 y_2 &= \Delta^2 y_1 + \Delta^3 y_1 \end{aligned}$$

$$\begin{aligned} \therefore y_1 &= y + \Delta y \\ y_2 &= y + 2\Delta y + \Delta^2 y \\ y_3 &= y + 3\Delta y + 3\Delta^2 y + \Delta^3 y \\ y_4 &= y + 4\Delta y + 6\Delta^2 y + 4\Delta^3 y + \Delta^4 y \end{aligned}$$

And here comes Pascal's Triangle again. It follows that

$$y_n = y + n\Delta y + n \cdot (n-1)/2 \cdot \Delta^2 y + n \cdot (n-1)/2 \cdot (n-2)/3 \cdot \Delta^3 y + \dots \quad [1]$$

Now let  $x$  become  $x+h$  in  $n$  steps:  $x, x + h/n, x + 2h/n, \dots, x + nh/n = x+h$  so that  $n\Delta x = h$ . By multiplying every factor of [1] which contains  $n$  by  $\Delta x$  and dividing the accompanying difference of  $y$  by  $\Delta x$  as many times as there are factors with  $n$ :

$$\varphi(x + n\Delta x) = y + n\Delta x \cdot \Delta y / \Delta x + n\Delta x \cdot (n\Delta x - \Delta x) / 2 \cdot \Delta^2 y / dx^2 + \dots$$

And subbing  $h$  for  $n\Delta x$ , [1] becomes:

$$\varphi(x+h) = y + h \cdot \Delta y / \Delta x + h \cdot (h - \Delta x) / 2 \cdot \Delta^2 y / dx^2 + h \cdot (h - \Delta x) / 2 \cdot (h - 2\Delta x) / 3 \cdot \Delta^3 y / dx^3 + \dots$$

If we diminish  $\Delta x$  without limit by increasing the  $n$  steps without limit, we have:

$$\varphi(x+h) = y + dy/dx \cdot h + d^2y/dx^2 \cdot h^2/2! + d^3y/dx^3 \cdot h^3/3! + \dots$$

where  $dy/dx, d^2y/dx^2, \dots$  are the limits of the ratio of our  $n$  increments and are therefore the finite limits of  $\varphi'x, \varphi''x, \varphi'''x$ , and so on.

## Implicit Derivatives and Functions

Let  $z$  be a function of  $x$  and  $y$  where  $y$  is a function of  $x$  or  $z = x \cdot \ln y$  and  $y = \sin x$  so  $z$  is  $x \cdot \ln(\sin x)$ . But let's consider  $z$  as  $f(x,y)$ . If we take the total partial derivative here:

$$dz = dz/dx \cdot dx + dz/dy \cdot dy \quad [1]$$

But  $dy$  is not independent of  $dx$ . It is itself a series:  $pdx + qdx^2 + \dots$  where  $p = dy/dx = \varphi'x$  and so on. In other words:

$$dz = dz/dx \cdot dx + dz/dy \cdot p \cdot dx \therefore dz/dx = dz/dx + dz/dy \cdot p \quad [2]$$

Here  $dz/dx$  is the **total variation** of  $z$  and  $y$  is a function of  $x$ . So if  $x$  becomes  $x+dx$ ,  $z$  gets a different increment than it would if  $y$  was independent of  $x$ . If in [1]  $x \rightarrow x+dx$  then  $z$  becomes  $x \cdot \log y + \log y \cdot dx$  or  $dz/dx = \log y$  (which I suspect is  $\ln x$ ). If in [1] only  $y$  varies then  $z$  becomes  $x \cdot \log y + x \cdot dy/y$  - (series continues for  $\sin x$ ) and  $dz/dy = x/y$ . But

$$dz/dx + dz/dy \cdot p = dz/dx + dz/dy \cdot dy/dx = \log y + x/y \cdot \cos x$$

or

$$\log \sin y + x/(\sin x) \cdot \cos x \quad [3]$$

If we began with  $x \cdot \log(\sin x)$ , we could arrive by a more complicated process at [3]. But [3] from [2] is the **total** or **complete** derivative wrt  $x$  where [1] is the partial derivative. Denote the total derivative by  $d.z/dx$  and consider:

$$d.z/dx = dz/dx + dz/dy \cdot dy/dx + dz/da \cdot da/dy \cdot dy/dx + dz/da \cdot da/dx \quad [4]$$

When  $x$  is contained directly in  $z$ ,  $z$  is a **direct** function of  $x$ . When  $z$  contains  $y$  and  $y$  is a fn of  $x$ ,  $z$  is an **indirect** fn of  $x$ . In [4]

1.  $dz/dx$  shows  $z$  is a direct fn of  $x$  and we get this coeff by changing  $x$  to  $x+dx$
2.  $dz/dy \cdot dy/dx$  shows that  $z$  is an indirect fn of  $x$  through  $y$ . Here  $dy$  is the series  $pdx + qdx^2 + \dots$ . So  $dz/dy \cdot dy = dz/dy \cdot p$  or  $dz/dy \cdot dy/dx$ .
3.  $dz/da \cdot da/dy \cdot dy/dx$  shows  $z$  contains a fn **a** which contains a fn  $y$  which is a fn of only  $x$ .
4.  $dz/da \cdot da/dx$  shows that  $a$  is a fn of  $x$  and again  $z$  contains  $x$  indirectly through  $a$ .

**Example**  $z = x^2 y a^3$   $y = x^2$   $a = x^3 y$

Taking  $z$  alone:  $dz/dx = 2xya^3$   $dz/dy = x^2 a^3$   $dz/da = 3x^2 y a^2$

Taking  $y$  alone:  $dy/dx = 2x$

Taking  $a$  alone:  $da/dx = 3x^2 y$   $da/dy = x^3$

Substituting these in [4]

$$= 2xya^3 + x^2 a^3 \cdot 2x + 3x^2 y a^2 \cdot 2x + 3x^2 y a^2 \cdot 3x^2 y$$

$$= 2xya^3 + 2x^3 a^3 + 6x^6 y a^2 + 9a^4 y^2 a^2 \quad [5]$$

If for  $y$  and  $a$  in the original, you substitute their values  $x^2$  and  $x^3 y = a^5$ , we have  $z = x^{19}$

Subbing them into [5] gives us  $2x^{18} + 2x^{18} + 6x^{18} + 9x^{18} = 18x^{18}$

In general if

z contains x

$$dz/dx$$

z contains y contains x

$$dz/dy \cdot dy/dx$$

z contains y contains a contains x

$$dz/dy \cdot dy/da \cdot da/dx$$

and so on. This idea can be imposed on a function as a tool for derivatives and is now called the **Chain Rule**:

$$\text{Let } z = \ln(x^2 + a^2) \text{ and } y = x^2 + a^2$$

$$\therefore z = \ln y \quad dz/dy = 1/y \text{ and } dy/dx = 2x$$

$$\therefore dz/dx = dz/dy \cdot dy/dx = 1/y \cdot 2x = 2x/y = 2x/(x^2 + a^2)$$

Again, let  $z = \ln \ln \sin x$ .

Then  $y = \sin x$  and  $a = \ln y \therefore z = \ln a$

$$\therefore dz/dx = dz/da \cdot da/dy \cdot dy/dx$$

$$z = \ln a \therefore dz/da = 1/a$$

$$a = \ln y \therefore da/dy = 1/y$$

$$y = \sin x \therefore dy/dx = \cos x$$

$$\therefore dz/dx = 1/a \cdot 1/y \cdot \cos x \\ = (\cos x)/(\ln(\sin x) \cdot \sin x)$$

Let's do products and quotients again from this point of view.

Let  $z = ab$  where  $a, b$  are fns of  $x$ .

$$dz/dx = dz/da \cdot da/dx + dz/db \cdot db/dx$$

If  $a \rightarrow a+da$  then  $z = ab + bda \therefore dz/da = b$ . Sym.  $dz/db = a$ .

$$\therefore dz/dx = b \cdot da/dx + a \cdot db/dx$$

Let  $z = a/b$ .

$a \rightarrow a+da$ ,  $z = (a+da)/b = a/b + da/b \therefore dz/da = 1/b$ .

$b \rightarrow b+db$ ,  $z = a/(b+db) = a/b - adb/b^2 + \dots \therefore dz/db = -a/b^2$

$$\therefore dz/dx = 1/b \cdot da/dx - a/b^2 \cdot db/dx = (b \cdot da/dx - a \cdot db/dx)/b^2$$

Let  $z = a^b$

$(a + da)^b = a^b + ba^{b-1}da + \dots \therefore dz/da = ba^{b-1}$

$a^{b+db} = a^b \cdot a^{db} = a^b(1 + \ln a \cdot db + \dots) \therefore dz/db = a^b \ln a$

$$\therefore dz/dx = ba^{b-1} \cdot da/dx + a^b \ln a \cdot db/dx$$

Let  $y$  be a fn of  $x$ :  $y = \phi x$ . Then we can often determine  $x$  in terms of  $y$  or  $x = \psi y$ :

$$y = 2x$$

$$x = y/2$$

These fns are the same relation in different forms:  $x = \psi \phi x$ . These are the inverse fns we've seen before. We then have  $dy/dx = \phi'x$  and  $dx/dy = \psi'x$ . It follows the

$$dy/dx \cdot dx/dy = 1 \quad \text{or} \quad \phi'x \cdot \psi'x = 1$$

So these  $\phi'$ ,  $\psi'$  are reciprocals for all  $x$  and  $y$  in their domains. Let  $y = \epsilon^x$  and  $x = \ln y$  then  $y' = \epsilon^x$  and  $x' = 1/y \therefore$  whenever  $y = \epsilon^x$  then  $\epsilon^x \cdot 1/y = 1$ . Let  $y = \phi x$ ,  $x = \psi y$  then

$$dy/dx = \phi'x = 1/\psi'y = 1/p$$

Let  $1/p = u$ . Then  $du/dp \cdot dp/dy \cdot dy/dx = du/dx$ .

$$u = 1/p \therefore du/dp = -1/p^2 \therefore dp/dy = \psi'y$$

$$\text{Also } 1/p^2 = 1/(\psi'y)^2 = (\phi'x)^2 = (dy/dx)^2$$

$\therefore$  the coeff of  $u$  or  $dy/dx$  wrt  $x$  which is  $d^2y/dx^2$  is also:

$$-(dy/dx)^2 \cdot d^2x/dy^2 \cdot dy/dx = -(dy/dx)^3 \cdot d^2x/dy^2$$

If  $y = \epsilon^x$  and  $x = \ln y$  then  $dy/dx = \epsilon^x$  and  $d^2y/dx^2 = \epsilon^x$ .

But  $dx/dy = 1/y$  and  $d^2x/dy^2 = -1/y^2$

$$\therefore -(dy/dx)^3 \cdot d^2x/dy^2 = -\epsilon^{3x} \cdot (-1/y^2) = \epsilon^{3x}/y^2 = \epsilon^{3x}/\epsilon^{2x} = \epsilon^x$$

Sym.  $d^3y/dx^3$  can be expressed in terms of  $dx/dy$ ,  $d^2x/dy^2$ ,  $d^3x/dy^3$ , and so on.

If we have two eqns in two vars, we have no independent vars as, from our algebra section, we can only satisfy these eqns with a finite number of values. With  $m$  eqns,  $n$  vars ( $n > m$ ) we have  $(n-m)$  ind.vars. If we have

$$\phi(a, b, x, y, z) = 0$$

$$\psi(a, b, x, y, z) = 0$$

$$\chi(a, b, x, y, z) = 0$$

we can determine three vars, say  $a, b, z$ , leaving two ind.vars and then we can determine  $da/dx$ ,  $da/dy$ ,  $db/dx$ , and so on. When  $y$  is a fn of  $x$  or  $y = \phi x$ ,  $y$  is an **explicit** fn of  $x$ . Given any  $x$ , we can determine  $y = \phi x$ . But in  $x^2 - xy + y^2 = a$ , when  $x$  is known,  $y$  must be determined by a quadratic soln. Here  $y$  is an **implicit** fn if  $x$ .

We can bring such a fn  $\phi(x, y)$  to the form  $\phi(x, y) = 0$  or  $x^2 - xy + y^2 = 0$ . We want to determine  $dy/dx$  from this  $\phi(x, y) = 0$ . Let  $u = \phi(x, y)$  and let  $x, y$  become  $x+dx, y+dy$ . Then

$$du = du/dx \cdot dx + du/dy \cdot dy$$

But  $du = 0 \therefore du/dx \cdot dx + du/dy \cdot dy = 0$  or

$$dy/dx = -(du/dx)/(du/dy)$$

and  $x, y, dx, dy$  are no longer independent.

Let  $xy - x = 1 \therefore xy - x - 1 = 0 = u$

$$\therefore du/dx = y - 1 \quad du/dy = x \quad \therefore dy/dx = -(y - 1)/x \quad [1]$$

Solving  $xy - x = 1$  for  $y$  we have  $y = 1 + 1/x$

$$\therefore dy = (1 + 1/(x+dx)) - (1 + 1/x) = -dx/x^2 + \dots$$

Therefore the limit of  $dy/dx$  is  $-1/x^2$  which is also the result of subbing  $1 + 1/x$  for  $y$  into [1].

## Integral Calculus

We have seen that when two fns increase or decrease without limit their ratio may have a finite limit. But it is also true that if  $x \rightarrow$  some value and  $f(x) \rightarrow 0$  and  $g(x) \rightarrow \infty$  then  $f(x) \cdot g(x)$  may go to some finite limit. Let  $f = \cos x$  and  $y = \tan x$  then as  $x \rightarrow \pi/2$  then  $f \rightarrow 0$ ,  $g \rightarrow \infty$  but  $f \cdot g$  (which is not  $f \cdot g$ ) or  $\cos x \cdot \tan x = \sin x \rightarrow 1$ .

Generally, if  $A \rightarrow 0$  and  $B \rightarrow \infty$  their product may, and often will, approach a finite limit. If  $B \rightarrow \infty$  then  $1/B \rightarrow 0$  then  $A:1/B = A/(1/B) = AB$  may have a finite limit. Or not. Consider  $\cos^2 \theta \tan \theta$  as  $\theta \rightarrow \pi/2$ .  $\cos^2 \theta \rightarrow 0$  and  $\tan \theta \rightarrow \infty$  but  $\cos^2 \theta \tan \theta = \cos \theta \sin \theta \rightarrow 0$ . Or  $\cos \theta \tan^2 \theta = \sin \theta \tan \theta \rightarrow \infty$  as  $\theta \rightarrow \pi/2$ .

Take any two numbers (1,2) and place any number of fractions (9) between them according to any law. We could have 1 1/10, 1 2/10, ... 1 9/10, 2. And if  $m$  fractions in A.P. are inserted between  $a$  and  $a+h$  we have

$$a, a + h/(m+1), a + 2h/(m+1), \dots, a + mh/(m+1), a + h \quad [1]$$

The sum of these is unbounded, as all are greater than  $a$  and  $m$  can be any number. The same applies to any  $\varphi x$ :

$$\varphi a, \varphi(a + h/(m+1)), \varphi(a + 2h/(m+1)), \dots, \varphi(a + mh/(m+1)), \varphi(a + h) \quad [2]$$

This sum also is unbounded. Though both sums can increase without limit, we can show their ratio must approach a finite limit when all the terms of [2] are finite. Let  $A$  be greater than any term in [2] then  $(m+2)A > \Sigma[2]$ . And in [1],  $a$  being the least term  $a(m+2)$  is less than  $\Sigma[1]$ .

$$\therefore ((m+2)A) / ((m+2)a) > \Sigma[2] / \Sigma[1]$$

But the LHS is independent of  $m$  and equals  $A/a$  which is finite. If  $m \rightarrow \infty$  then the interval between the terms  $h/(m+1) \rightarrow 0$  and if we multiply [2] by  $h/(m+1)$  we have a product where one term increases without limit and the other decreases without limit as  $m \rightarrow \infty$ . Yet this product has a finite limit.

Consider  $f(x) = x^2$  between  $a$  and  $a+h$ . Let  $v = h/(m+1)$ . Then the product here is:

$$v(a^2 + (a+v)^2 + (a+2v)^2 + \dots + (a+(m+1)v)^2) \\ = (m+2)va^2 + 2av^2(1+2+\dots+(m+1)) + v^3(1^2+2^2+\dots+(m+1)^2)$$

where  $(1+2+\dots+(m+1)) = \frac{1}{2}(m+1)(m+2)$  and  $(1^2+2^2+\dots+(m+1)^2) = \frac{1}{3}(m+1)^3$  as  $m \rightarrow \infty$ . So our product becomes, subbing  $h/(m+1)$  for  $v$ :

$$(m+2)/(m+1) \cdot ha^2 + (m+2)/(m+1) \cdot h^2 a + (1+\alpha) \cdot h^3 / 3$$

Here  $\alpha$  is the rest of the terms in the coeff of  $h^3/3$ . As  $m \rightarrow \infty$  both  $1+\alpha$  and  $(m+2)/(m+1)$  go to 1. Then the limit of the product as  $m \rightarrow \infty$  is

$$ha^2 + h^2 a + h^3 / 3 = ((a+h)^3 - a^3) / 3$$

Or as a, a+dx, a+2dx, ..., a+h is taken with smaller and smaller dx, the sum approaches

$$((a+h)^3 - a^3)/3$$

This limit is the **integral** of  $x^2 dx$  between a and a+h or:

$$\int_a^{a+h} x^2 dx$$

I want to point out some important things here.

1. Our integral above is a **definite** integral on [a,a+h]
2. The **indefinite** integral is  $\int x^2 dx = x^3/3 + C$   
So the integral is the thing whose derivative is the fn in the integral. Or the integral is the **anti-derivative**. Think of it this way: The LHS asks, "What is the integral?" and the RHS answers the question. The C is any constant and we can't, in an indefinite integral, know which constant it is because the derivative of any constant is 0.
3. Conceptually, when our  $h/(m+1) \rightarrow 0$  we are getting every y for every x and summing all the y values. The **definite integral** sum is the area between a and a+h and between f(x) and the x-axis.
4. It follows that the definite integral is the area under f on [0,a+h] minus the area under f on [0,a] or  $(a+h)^3/3 - a^3/3$  from  $x^3/3 + C$  where C has no part to play here.

Let's prove that the integral is the anti-derivative. We divide the integral with a, a+dx, a+2dx, ..., a + mdx where dx is h/m so a+mdx = a+h. Now expand these as we have been doing:

$$\begin{aligned} \varphi a &= \varphi a \\ \varphi(a+dx) &= \varphi a + \varphi' a \cdot dx + \varphi'' a \cdot dx^2/2! + \dots \\ \varphi(a+2x) &= \varphi a + \varphi' a \cdot 2dx + \varphi'' a \cdot 2dx^2/2! + \dots \\ \dots & \\ \varphi(a+mdx) &= \varphi a + \varphi' a \cdot mdx + \varphi'' a \cdot mdx^2/2! + \dots \end{aligned}$$

Multiply each by dx and sum (vertically) for each coeff:

$$\begin{aligned} \varphi a \cdot mdx & \\ \varphi' a \cdot (1 + 2 + \dots + m) \cdot (dx)^2 & \\ \varphi'' a \cdot (1^2 + 2^2 + \dots + m^2) \cdot (dx)^3/2! & \\ \varphi''' a \cdot (1^3 + 2^3 + \dots + m^3) \cdot (dx)^4/3! & \\ \dots & \end{aligned}$$

As above, we represent the sums in parens as

$$\begin{aligned} \frac{1}{2}m^2(1 + \alpha) & \\ \frac{1}{3}m^3(1 + \beta) & \\ \frac{1}{4}m^4(1 + \gamma) & \\ \dots & \end{aligned}$$

where  $\alpha, \beta, \gamma \rightarrow 0$  as  $m \rightarrow \infty$ . Subbing these and using h/m for dx, we get:

$$\varphi ah + \varphi a \cdot h^2/2! \cdot (1+\alpha) + \varphi'' a \cdot h^3/3! \cdot (1+\beta) + \varphi''' a \cdot h^4/4! \cdot (1+\gamma) + \dots$$

Let  $m \rightarrow \infty$  and we have the limit:

$$\phi ah + \phi a \cdot h^2/2! + \phi'' a \cdot h^3/3! + \phi''' a \cdot h^4/4! + \dots$$

And this is our integral on  $[a, a+h]$ . Compare this with our expansion of  $\phi(x+h)$  in the Taylor Theorem section. Let  $\psi'a = \phi a$ . These fns being the same, their differential coeffs will be the same or  $\psi''a = \phi'a$  and then  $\psi'''a = \phi''a$  and so on. Sub these into our last series and we have:

$$\psi'a h + \psi''a \cdot h^2/2! + \psi'''a \cdot h^3/3! + \dots$$

which is  $\psi(a+h) - \psi a$ . This **means** the integral of  $\phi x$  on  $[a, a+h]$  is  $\psi(a+h) - \psi a$  where  $\psi x$  is the fn which when differentiated gives  $\phi$ . Let  $a+h = b$ . The definite integral is

$$\int_a^b \phi x \, dx = \psi b - \psi a$$

Now if you think about it (and you **will** think about it) this means that for  $x^3/3 + C$ ,  $b = x$  and  $C = -\psi a$ . So I lied. The C does play a part here but the **definite interval** takes care of it for you when you calculate the **definite integral**.

Our final investigation is to pursue the idea of the integral as the area bounded by the x-axis and a curve  $f(x)$  between the endpoints of the interval  $[a, b]$ . Consider the curve bounded by  $MPP'M'$ . We divide  $MM'$  into  $n$  equal parts.  $O$  is the origin.  $OM$  is  $x = a$ .  $OM'$  is  $x = b$ . We have divided  $MM'$  into 4 parts but the reasoning would be the same if there were  $4 \cdot 10^n$  parts where  $n$  is any finite number. The 4, of course, is arbitrary too.

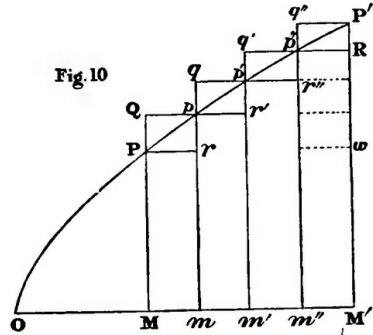

The sum of the parallelograms  $Mr + mr' + m'r'' + m''R < MPP'M'$  by the sum of the curvilinear triangles  $Prp$ , etc. And the sum of these triangles is less than the sum of  $\|gms$   $Qr + qr' + \dots$ . But these  $\|gms = \|gm q''w$ . So the sum  $Mr + mr' + m'r'' + m''R$  differs from  $MPP'M'$  by less than  $\|gm q''w$ . But  $q''w \rightarrow 0$  as  $n \rightarrow \infty$  (here  $n=4$ ). Therefore the curvilinear area  $MPP'M'$  is the limit we approach as we divide  $MM'$  into more and more parts which is as  $n \rightarrow \infty$ . And these parts are  $a, a+dx, a+2dx, \dots$ . So the sum of their area is

$$\phi a dx + \phi(a+dx)dx + \phi(a+2dx)dx + \dots$$

And this limiting sum we defined as the definite integral of  $\phi x$  on  $[a, b]$ . So if  $\psi'x = \phi x$ , then this sum is  $\psi b - \psi a$ . As  $y$  is the ordinate, we have  $\int y \, dx$  on  $[a, b]$  as the sum.

Consider the parabola  $y^2 = px$  where  $p$  is the double ordinate on the focus.

Here  $y = p^{1/2} x^{1/2}$  and we need the integral of  $p^{1/2} x^{1/2} dx$ .

If we take  $cx^n$  where  $c$  is independent of  $x$  and sub  $x+h$  for  $x$  we get:

$$cx^n + cnx^{n-1}h + cn(n-1) \cdot h^2/2! + \dots$$

So the differential coeff of  $cx^n$  is  $ncx^{n-1}$

$$\therefore cn = p^{1/2} \quad n-1 = 1/2 \quad \therefore n = 3/2 \quad c = 2/3 \cdot p^{1/2}$$

$$\therefore \int p^{1/2} x^{1/2} dx = 2/3 \cdot p^{1/2} x^{3/2} + C$$

$\therefore$  The area under the parabola is  $2/3 \cdot p^{1/2} b^{3/2} - 2/3 \cdot p^{1/2} a^{3/2}$  and here  $a = 0$ .

$\therefore$  Area  $2/3 \cdot p^{1/2} b^{1/2} \cdot b$  where  $b = OM'$  and  $p^{1/2} b^{1/2}$  is  $M'P'$

$\therefore$  Area =  $2/3 \cdot M'P' \cdot OM'$  or two-thirds the rectangle  $OM' \cdot M'P'$



## Afterword

If you are serious about mastering what you have finished by arriving at this page, here is a suggestion. Put the book aside for a month or two. Then, at your leisure, read it all the way through. Do two things as you read:

1. Make sure you follow the **reasoning** behind every idea; and
2. Make you you can **actually do** each computation that arises.

The key here, and what you are really learning, is self-honesty. Your goal, with any text of mathematics you care about (and you can't care about all of them or you will drown) is to honestly know that you can demonstrate, in a practical way, your understanding of all the ideas in the text which are a) important to you and b) are important to the understanding of those ideas which are important to you.

It is never too late to achieve a demonstrable understanding.